

Fundamentals of General and Physical Chemistry

J.E. Imanah
B.Sc.(Ed), M.Sc., Ph.D
(MIWA, FCSN, FPIN MMSN)

A.O. Oladebeye
HND, PGD, B.Sc., M.Tech., Ph.D
(MCSN, MPIN, M.AES)

PREFACE

Fundamentals of General and Physical Chemistry is based on the ND and HND curricula of BCH 111 and PLT 311 given at Auchu Polytechnic, Auchu. Much of the content is essentially conventional character and treats the fundamentally important aspects of General and Physical Chemistry. This will provide a readable handbook for students in which the basic principles of General and Physical Chemistry are presented clearly and in a simple fashion, avoiding in many instances, detailed mathematical treatment particularly when this does not necessarily lead to a clearer understanding of the text.

A number of equations have been derived throughout the book to illustrate the methods and relationships presented and to enable the students relate the principles discussed to practical situations.

This book is not a compendium of facts, therefore, the students must have access to other textbooks, especially those listed under bibliography, to enable them solve practical problems related to each topic. In other words, the book is only a skeleton which students must flesh.

All criticisms and suggestions from students and colleagues will be gratefully received.

J.E. Imanah and A.O. Oladebeye

DEDICATION

This book is dedicated to the ALMIGHTY FATHER, the Creator of all.

FOREWORD

There is nothing in this whole world that is not chemistry. It is the second greatest power in the world next to the power of creating something out of nothing. No aspect of science and technology agriculture, dentistry, engineering, medicine, and pharmacy in which the knowledge of chemistry is not fundamentally important.

The dilemma we face today is the increasing difficulty in attracting students in sufficient number and of acceptable minimum quality into science programmes in higher institutions nationwide. The perception of chemistry is that it is a difficult and volatile subject with too many equations, formulae, structures, calculations etc. to learn. May be it is the method of presentation of the subject matter that has stood in the way of many would be chemists.

Fundamentals of General and Physical Chemistry is a courageous attempt to facilitate learning and assimilation of the basic principles of general and physical chemistry at the tertiary level. The book is well written and covers major aspects of general and physical chemistry as well as all the aspects of general and advanced physical chemistry of the National Diploma (ND) and Higher National Diploma (HND) programmes. The topics are presented in student-friendly manner and have worked examples and questions within each chapter. Fundamentals of General and Physical Chemistry should make chemistry course at the tertiary levels easier to comprehend by students.

I commend the authors for this contribution to the facilitation of teaching and learning aspects of chemistry. The book is a valuable contribution to the discipline and profession of

chemistry and will prove valuable to students and teachers also in the Colleges of Education and Universities.

Prof. Felix E. Okieimen

PhD; Cchem, FRSC

Former Deputy Vice Chancellor (Academics)

University of Benin, Benin-City, Nigeria

CHAPTER ONE

1.0 Matter and its Particulate Nature

Matter is defined as

“that which has mass and occupies space.”

This definition seems simple enough, yet there are profound issues which surround it. For example, there is currently no generally accepted scientific theory for why mass exists. It can be defined,

“mass characterizes an object's resistance to a change in its motion.”

But why it exists cannot yet be demonstrated. Mass just is, it just exists. The mass is the amount of matter in an object, which is not the same thing as its weight. The weight is a measure of the gravitational force exerted on an object. As long as the gravity is uniform (earth's surface), the weight does not change. Hence, we can freely use the word mass or weight; it does not make any difference. However, if the gravitational forces are not the same (earth vs. moon), the weight differs from the mass. For example, the same astronaut (same mass) weighs differently on earth and on moon.

As we look into it more, definitions start to become circular, as in the definition of space:

“space is that which is occupied by matter.”

So, any definition of space exists only if there is matter. Take the matter away and space ceases to exist. Of course, saying "take the matter away" is very easy to say. It is quite another thing to specify what is meant by it. The entire universe is made of two things: matter and energy. All living and non-living things are made up of matter.

All matter is particulate in nature. This basically means that between separate bits of matter there are spaces which contain

no matter. In science it is called the “atomic nature of matter”. It is generally agreed that the Greek philosopher Leucippus and his student Democritus were the first to propose this idea, about 440 B.C. This “atomic theory” (to use a modern phrase) was opposed by Aristotle 100 years later, who taught that all space is filled with matter, that there are no empty spaces. Aristotle's ideas were accepted as correct by almost all educated people, until the early 1800's, when atomic ideas began to be more generally accepted as correct.

Today, we know that there are many different particles which make up matter. Some are long-lasting, such as the proton. Others are very, very short-lived, such as the top quark. The primary “particle” in chemistry is the atom. However, you probably know that there is a substructure to an atom; that it is made of protons, neutrons and electrons. You may also know that protons and neutrons are each made of three quarks. There are many other particles beyond the proton and neutron, some containing two quarks and some containing three.

There are two other categories of particles which appear to NOT be made of quarks: electrons and neutrinos. As far as science is currently able to tell, there are three types of particles with no substructure that we can detect: quarks, electrons and neutrinos. It may be that someday we will learn the electron, for example, is made of still smaller pieces like an atom is made of protons, neutrons and electrons.

There is also a fairly sophisticated concept called “virtual particles”. While it is based on some concepts you have not yet learned, it is still fairly easy to describe in a general way. There is energy also in the universe, we are just ignoring it for the time being in this tutorial. Some of the energy can spontaneously merge to form a particle of matter. (Einstein showed that matter and energy can be converted, one into another.) These “virtual particles” exist for very, very small amounts of time, so small that we cannot detect them before that pop back into being the energy they were made from.

Since the universe is flooded with energy, this means that, in every square centimetre of the universe, are trillions and trillions of virtual particles popping into existence every fraction of a second and then going back to energy. “Empty” space is actually a boiling cauldron of particles. Even though individual particles cannot be detected, the effect can. If you want to look into this farther, look up the “Casimir Effect” as well as learn what “polarizability of the vacuum” or “quantum fluctuation of the vacuum” means. It may be that Aristotle was right all along.

The fundamental building block of matter is the atom. However, the term “atom” just refers to a building block of matter; it doesn't specify the identity of the atom. It could be an atom of carbon, or an atom of hydrogen, or any other kind of atom. Any atom is composed of a little nucleus surrounded by a “cloud” of electrons. In the nucleus there are protons and neutrons.

The atom is the basic building block for all matter in the universe. Atoms are extremely small and are made up of a few even smaller particles. The basic particles that make up an atom are electrons, protons, and neutrons. Atoms fit together with other atoms to make up matter. It takes a lot of atoms to make up anything. There are so many atoms in a single human body we won't even try to write the number here. Suffice it to say that the number is trillions and trillions (and then some more).

There are different kinds of atoms based on the number of electrons, protons, and neutrons each atom contains. Each different kind of atom makes up an element. There are 92 natural elements and up to 118 when you count in man-made elements.

Atoms last a long time, in most cases forever. They can change and undergo chemical reactions, sharing electrons with other atoms. But the nucleus is very hard to split, meaning most atoms are around for a long time.

1.1 Classification of Matter

The matter can be classified in two different ways; (a) according to its state, and (b) according to its composition.

Classification According to its States

Matter exists, at room temperature, in three different states namely: solid, liquid and gaseous states. Adsorption or evolution of heat results in the interconversion of these states. There are two other states of matter, plasma state and Bose-Einstein condensate, which occur at a very high temperature of 10^5 K and very low temperature of less than 10^{-7} K respectively.

Solids

Solids have a definite shape and a definite volume. Most everyday objects are solids: rocks, chairs, ice, and anything with a specific shape and size. The molecules in a solid are close together and connected by intermolecular bonds. Solids can be amorphous, meaning that they have no particular structure, or they can be arranged into crystalline structures or networks. For instance, soot, graphite, and diamond are all made of elemental carbon, and they are all solids. What makes them so different? Soot is amorphous, so the atoms are randomly stuck together. Graphite forms parallel layers that can slip past each other. Diamond, however, forms a crystal structure that makes it very strong.

Liquids

Liquids have a definite volume, but they do not have a definite shape. Instead, they take the shape of their container to the extent they are indeed “contained” by something such as beaker or a cupped hand or even a puddle. If not “contained” by a formal or informal vessel, the shape is determined by other internal (e.g. intermolecular) and external (e.g. gravity, wind, inertial) forces. The molecules are close, but not as close as a solid. The intermolecular bonds are weak, so the molecules are

free to slip past each other, flowing smoothly. A property of liquids is viscosity, the measure of “thickness” when flowing. For example, water is not nearly as viscous as molasses.

Gases

Gas particles have a great deal of space between them and have high kinetic energy. If unconfined, the particles of a gas will spread out indefinitely; if confined, the gas will expand to fill its container. When a gas is put under pressure by reducing the volume of the container, the space between particles is reduced, and the pressure exerted by their collisions increases. If the volume of the container is held constant, but the temperature of the gas increases, then the pressure will also increase. Gas particles have enough kinetic energy to overcome intermolecular forces that hold solids and liquids together, thus a gas has no definite volume and no definite shape.

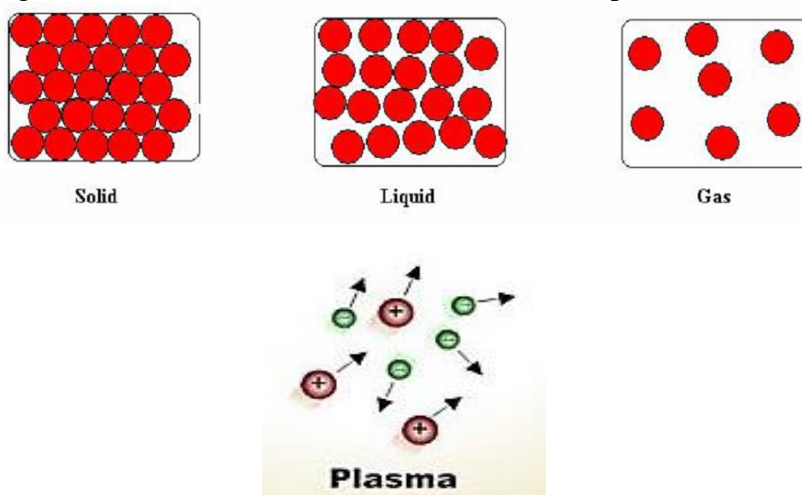

Figure 1.1: Solid, liquid, gaseous and plasma states of matter

Plasma

Plasma is not a common state of matter here on Earth, but may be the most common state of matter in the universe. Plasma

consists of highly charged particles with extremely high kinetic energy. The noble gases (helium, neon, argon, krypton, xenon and radon) are often used to make glowing signs by using electricity to ionize them to the plasma state. Stars are essentially superheated balls of plasma.

Bose-Einstein Condensates

In 1995, technology enabled scientists to create a new state of matter, the Bose-Einstein condensate (BEC). Using a combination of lasers and magnets, Eric Cornell and Carl Weiman cooled a sample of rubidium to within a few degrees of absolute zero. At this extremely low temperature, molecular motion comes very close to stopping altogether. Since there is almost no kinetic energy being transferred from one atom to another, the atoms begin to clump together. There are no longer thousands of separate atoms, just one “super atom.”

A BEC exists when matter is frozen to extremely low temperatures that are a tiny fraction of a degree above absolute zero. In this state, the atoms overlap into each other to form a wave. The BEC is a matter wave. If the wave was compressed, it would form a singularity. If enough mass was condensed into the singularity it could turn into a black hole. The occurrence of a black hole while making BEC would not need to be too much of a concern anyway because it would require a tremendous amount of energy to compress mass into the critical point.

A BEC is used to study quantum mechanics on a macroscopic level. Light appears to slow down as it passes through a BEC, allowing study of the particle/wave paradox. A BEC also has many of the properties of a superfluid – flowing without friction. BECs are also used to simulate conditions that might apply in black holes.

Classification According to its Composition

Matter is classified into two broad categories, namely, pure substances and mixtures. Mixtures can be separated into pure

substances by physical methods. Pure substances are further divided into categories as elements and compounds. Similarly, mixtures are also classified into types; homogeneous mixtures and heterogeneous mixtures (see Figure 1.2).

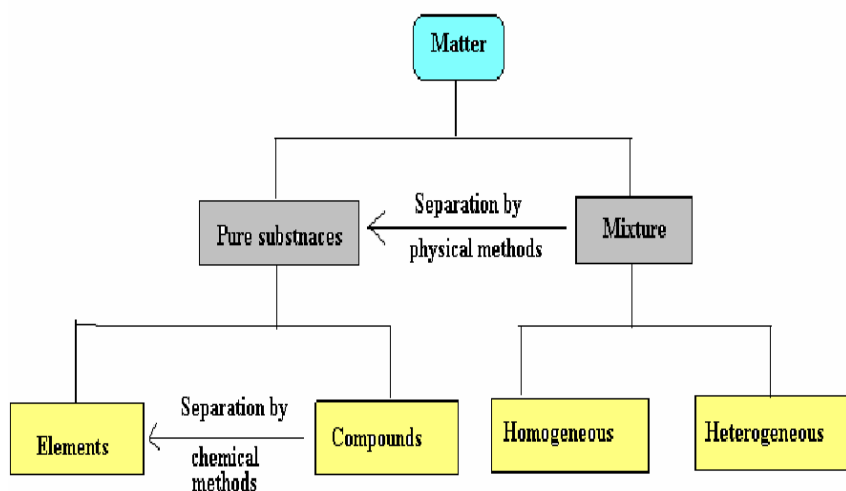

Figure 1.2: Classification of matter according to its composition

1.2 Chemical Substances

In chemistry, a chemical substance is a form of matter that has constant chemical composition and characteristic properties. It cannot be separated into components without breaking chemical bonds. Chemical substances can be solids, liquids, gases, plasma, or Bose-Einstein Condensate. Changes in temperature or pressure can cause substances to shift between the different phases of matter.

Element

An element is a chemical substance that is made up of a particular kind of atom and hence cannot be broken down or transformed by a chemical reaction into a different element. It is either discovered in nature or synthesized in the laboratory in pure form that cannot be separated into simpler substances by chemical methods. All atoms of an element have the same number of protons, though they may have different numbers of neutrons and electrons. Currently, there are about 118 elements discovered; some are found in nature and some are man-made. The periodic table is the diagrammatic and systematic arrangement of the elements in the order of their increasing atomic numbers and according to their families. Basically, there are three main classes of elements namely: the metals, the non-metals and the metalloids. However, with reference to the periodic table, there are broadly classified, based on their chemical properties, as alkali metals, alkaline-earth metals, lanthanides, actinides, transition metals, post-transition metals, metalloids, polyatomic non-metals, diatomic non-metals and noble gases. In order to call it as an element, its properties must be unique; no two elements are alike.

Names and Symbols of Elements

The names of the elements are given by its inventor(s):

1. Some are named after the place like an element Berkelium (Bk) after its discovery in Berkeley (University of California, Berkeley);
2. Some are based on planet, like element Mercury (Hg) named after the planet mercury;
3. Some, given to honour the great scientist, like Curium (Cm) after Madame Curie.

Similarly, elements have symbols, which are the short-hand notations for elements consisting of one or two letters:

1. The first letter is always in upper case and the second one in lower case;
2. Most of the symbols are derived from their English names except few that are derived from their Latin names;
3. One-letter symbols are taken from the first letter of the name. The two-letter symbols are derived in various ways. Some symbols are derived by the combination of the first letter and the second letter (e.g. Ba for Barium), some are of the first letter and the third letter (e.g. Cl for chlorine), etc.

Atomic Number, Mass Number and Atomic Weight

It is possible to confuse these values, but they are quite distinct from one another. Atoms consist of a nucleus containing positively charged protons and electrically neutral neutrons, with electrons orbiting some distance away. Protons and neutrons are relatively heavy, and similar in weight, but electrons are very much lighter and contribute very little to the weight of an atom.

The number of protons in an atom defines what element it is. For example, carbon atoms have six protons, hydrogen atoms have one, and oxygen atoms have eight. The number of protons in an atom is referred to as the atomic number of that element. The number of protons in an atom also determines the chemical behaviour of the element.

The mass number of an atom is the number of protons plus the number of neutrons and is nearly equal to the weight of the atom. The number of neutrons in an element can vary. Forms of an element with different numbers of neutrons are known as *isotopes*.

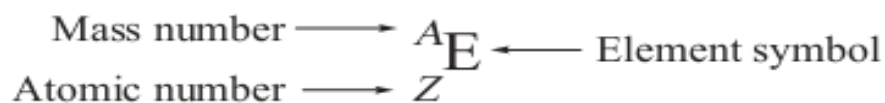

Mass number = A = number of protons + number of neutrons

Number of neutrons = $A - Z$

For instance, for a carbon atom, the atomic number and mass number are as presented below:

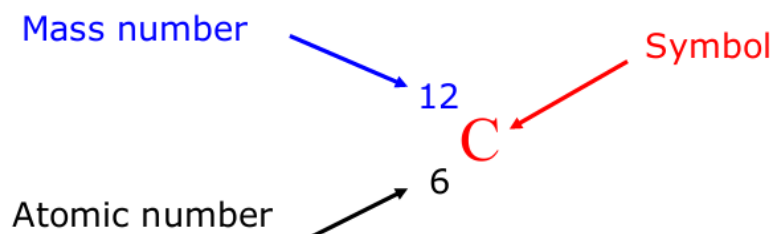

The atomic mass of an element is a weighted average of all the element's isotopes based on their natural abundance. The standard atomic weight is the average mass of an element in atomic mass units ("amu"). Though individual atoms always have an integer number of atomic mass units, the atomic mass on the periodic table is stated as a decimal number because it is an average of the various isotopes of an element. The atomic weight is usually determined as an average, based on the relative abundance of isotopes. Since some isotopes are unstable, changing over time into other elements, atomic weights can vary, and may be represented as a range, rather than a single value. Isotopes are usually represented with the atomic number at the bottom left of the chemical symbol, and the mass number, or approximate atomic weight, at the top right. For example, carbon-13 would be shown as $^{13}_6\text{C}$.

Example 1

You are given a sample containing 98% carbon-12 and 2% carbon-13. What is the relative atomic mass of the element?

Solution

1. First convert the percentages to decimal values by dividing each percentage by 100. The sample becomes 0.98 carbon-12 and 0.02 carbon-13.
2. Next, multiply the atomic mass of each isotope by the proportion of the element in the sample:
 $0.98 \times 12 = 11.76$
 $0.02 \times 13 = 0.26$
3. For the final answer, add these together:
 $11.76 + 0.26 = 12.02 \text{ g/mol}$

Note that:

1. The approximated value of atomic mass is given on a periodic table is given in atomic mass units or amu, but for chemistry calculations, atomic mass is usually written in terms of grams per mole or g/mol.
2. To calculate the atomic mass of a single atom of an element, add up the mass of protons and neutrons.

Example 2

Calculate the value of A_r for naturally occurring chlorine, if the distribution of isotopes is 75.77% $^{35}_{17}\text{Cl}$ and 24.23% $^{37}_{17}\text{Cl}$. Accurate masses for $^{35}_{17}\text{Cl}$ and $^{37}_{17}\text{Cl}$ are 34.97 and 36.96 respectively.

Solution

Relative atomic mass, $A_r \left(\frac{75.77}{100} \times 34.97 \right) + \left(\frac{24.23}{100} \times 36.97 \right) = 35.45 \text{ g/mol}$

Table 1.1: Names, symbols and origin of names of some elements

Element	Sym	Origin of name	Element	Sym	Origin of name
Aluminium	Al	the Latin name for alum, 'alumen' meaning <i>bitter salt</i>	Hydrogen	H	the Greek 'hydro' and 'genes' meaning <i>water-forming</i>
Americium	Am	Americas, the continent where the element was first synthesized	Iron	Fe	the Anglo-Saxon name <i>iren</i> (<i>ferrum</i> in Latin)
Antimony	Sb	the Greek 'anti – monos', meaning <i>not alone</i> (<i>stibium</i> in Latin)	Lead	Pb	the Anglo-Saxon <i>lead</i> (<i>plumbum</i> in Latin)
Argon	Ar	the Greek, 'argos', meaning <i>idle</i>	Magnesium	Mg	Magnesia, a district of Eastern Thessaly in Greece
Barium	Ba	the Greek 'barys', meaning <i>heavy</i>	Manganese	Mn	Either the Latin 'magnes', meaning <i>magnet</i> or from the <i>black magnesium oxide</i> , 'magnesia nigra'
Beryllium	Be	the Greek name for beryl, 'beryllo'	Mercury	Hg	Mercury, the first planet in the Solar System (Hg from former name <i>hydrargyrum</i> , from Greek <i>hydr-</i> water and <i>argyros</i> silver)
Boron	B	the Arabic 'buraq', which was the name for borax	Nitrogen	N	the Greek 'nitron' and 'genes' meaning <i>nitre-forming</i>
Bromine	Br	the Greek 'bromos' meaning <i>stench</i>	Oxygen	O	the Greek 'oxy' and 'genes' meaning <i>acid-forming</i>
Cadmium	Cd	the Latin name	Phosphorus	P	the Greek

		for the mineral calmine, 'cadmia'	s		'phosphoros', meaning <i>bringer of light</i>
Calcium	Ca	the Latin 'calx' meaning <i>lime</i>	Potassium	K	the English word <i>potash</i> (<i>kalium</i> in Latin)
Californium	Cf	State of California, USA, where the element was first synthesized	Silicon	Si	the Latin 'silex' or 'silicis', meaning <i>flint</i>
Carbon	C	the Latin 'carbo', meaning <i>charcoal</i>	Silver	Ag	the Anglo-Saxon name <i>siolfur</i> (<i>argentum</i> in Latin)
Chlorine	Cl	the Greek 'chloros', meaning <i>greenish yellow</i>	Sodium	Na	the English word <i>soda</i> (<i>natrium</i> in Latin)
Copper	Cu	the Old English name <i>coper</i> in turn derived from the Latin 'Cypriumaes', meaning <i>a metal from Cyprus</i>	Sulfur	S	Either from the Sanskrit 'sulvere', or the Latin 'sulfurium', both names for sulphur
Curium	Cm	Pierre Curie, a physicist, and Marie Curie, a physicist and chemist	Tin	Sn	the Anglo-Saxon word <i>tin</i> (<i>stannum</i> in Latin, meaning <i>hard</i>)
Fluorine	F	the Latin 'fluere', meaning <i>to flow</i>	Zinc	Zn	the German, 'zinc', which may in turn be derived from the Persian word 'sing', meaning <i>stone</i>
Gold	Au	the Anglo-Saxon word <i>gold</i> (<i>aurum</i> in Latin, meaning <i>glow of sunrise</i>)	Zirconium	Zr	the Persian 'zargun', meaning <i>gold coloured</i>

Compound

In contrast to elements, compounds are composed of different type of atoms. More precisely, a compound is a chemical substance that consists of two or more elements. A pure chemical compound is a chemical substance that is composed of a particular set of molecules or ions that are chemically bonded.

The smallest representative for a compound (which means it retains characteristics of the compound) is called a molecule. In other words, a molecule is the smallest particle that has any of the properties of a compound. A molecule is formed when two or more atoms join together chemically. A compound is a molecule that contains at least two different elements. All compounds are molecules but not all molecules are compounds. Molecular hydrogen (H_2), molecular oxygen (O_2) and molecular nitrogen (N_2) are not compounds because each is composed of a single element. Water (H_2O), carbon dioxide (CO_2) and methane (CH_4) are compounds because each is made from more than one element. The smallest bit of each of these substances would be referred to as a molecule. For example, a single molecule of molecular hydrogen is made from two atoms of hydrogen while a single molecule of water is made from two atoms of hydrogen and one atom of oxygen.

The formula for a molecule must be neutral. When writing the formula for an ionic compound, the charges on the ions must balance, the number of positive charges must equal the number of negative charges. Molecules are composed of atoms that have “bonded” together. As an example, the formula of a water molecule is “ H_2O ”: two hydrogen atoms and one oxygen atom.

When the compound is formed, altogether a new substance is formed and the properties of which are quite different from its reacting elements. Compounds can be separated into elements using chemical methods but not the physical methods.

A chemical compound can be either atoms bonded together in molecules or crystals in which atoms, molecules or

ions form a crystalline lattice. Compounds made primarily of carbon and hydrogen atoms are called organic compounds, and all others are called inorganic compounds. Compounds containing bonds between carbon and a metal are called organometallic compounds.

Compounds have properties different from the elements that created them. Water, for example, is composed of hydrogen and oxygen. Hydrogen is an explosive gas and oxygen is a gas that fuels fire. Water has completely different properties, being a liquid that is used to extinguish fires.

Chemical substances are often called 'pure' to set them apart from mixtures. A common example of a chemical substance is pure water; it always has the same properties and the same ratio of hydrogen to oxygen whether it is isolated from a river or made in a laboratory. Other chemical substances commonly encountered in pure form are diamond (carbon), gold, table salt (sodium chloride), and refined sugar (sucrose). Simple or seemingly pure substances found in nature can in fact be mixtures of chemical substances. For example, tap water may contain small amounts of dissolved sodium chloride and compounds containing iron, calcium, and many other chemical substances.

Chemical Mixtures

A mixture is a material system made up of two or more different substances, which are mixed but not combined chemically. A mixture refers to the physical combination of two or more substances in which the identities of the individual substances are retained.

Mixtures can be separated into their constituent parts by physical means (e.g. distillation of liquids or separating magnetic and non-magnetic solids using a magnet), and have many of the properties of their constituent parts (e.g. the element "oxygen" is part of the mixture "air" and some of the properties of air are due to the oxygen, albeit somewhat reduced compared with pure oxygen due to the presence of the other constituents of the mixture called "air").

Mixtures can broadly be classified as heterogeneous and homogeneous mixtures. However, they take the form of alloys, solutions, suspensions, and colloids.

All mixtures have two parts, the “dispersing medium” and the “dispersed phase”. Generally speaking, the dispersed phase is in the smaller amount and is spread throughout the dispersing medium. In most cases, the dispersed phase is quite small in amount compared to the amount of the dispersing medium.

Heterogeneous Mixtures

A heterogeneous mixture is a mixture of two or more chemical substances (elements or compounds), where the different components can be visually distinguished and easily separated by physical means.

Examples include:

- mixtures of sand and water
- mixtures of sand and iron filings
- a conglomerate rock
- water and oil
- a salad
- trail mix
- mixtures of gold powder and *silver* powder

Homogenous Mixtures

A homogeneous mixture is a mixture of two or more chemical substances (elements or compounds), where the different components cannot be visually distinguished. The composition of homogeneous mixtures is constant. Often separating the components of a homogeneous mixture is more challenging than separating the components of a heterogeneous mixture.

Solutions

They are a special type of homogeneous mixtures in which one substance (called the “solute”) is dissolved in another substance (called the “solvent”), e.g. salt water is salt dissolved in water – in such a way that the salt no longer exists as solid particles within the water.

Suspensions

Suspensions are heterogeneous fluid mixtures containing solid particles large enough for sedimentation, which means that the particles (compare with the “solute” part of a solution) will eventually settle to the bottom of the container (unlike in the case of colloids, below), e.g. particles of sand in water.

Colloids

Colloids are heterogeneous mixtures in which one substance is microscopically dispersed evenly throughout another substance (for comparison, the size of the particles of “solute” are greater than in the case of a solution, but much smaller than in the case of a suspension). There are many naturally occurring colloids, e.g. milk. Colloids are very important in biology and medicine.

Table 1.2: Types of Colloids

Dispersed Phase	Dispersing Medium		
	<i>Gas</i>	<i>Liquid</i>	<i>Solid</i>
<i>Gas</i>		Foam	Foam
<i>Liquid</i>	Aerosol	Emulsion	Gel
<i>Solid</i>	Aerosol	Sol	Solid Sol

Table 1.3: Examples of Colloids

		Dispersing Medium		
		<i>Gas</i>	<i>Liquid</i>	<i>Solid</i>
Dispersed Phase	<i>Gas</i>		shaving cream, whipped cream	foam rubber, sponge, pumice
	<i>Liquid</i>	fogs, clouds, aerosol can spray	mayonnaise, milk, face cream, hair gel	jelly, cheese, butter
	<i>Solid</i>	smoke, car exhaust, airborne viruses	Gold in water, milk of magnesia, river silt	alloys of metals (steel, brass)

Alloys

They are mixtures in which the main element(s) are metal(s). A more technical definition of an alloy is “a partial or complete solid solution of one or more elements in a metallic matrix”. Common examples of alloys include bronze, brass and steels.

1.2 Physical and Chemical Changes

Physical Changes

A physical change is any change NOT involving a change in the chemical identity of the substance. Energy is absorbed or released during a physical change.

Many physical changes also involve the rearrangement of atoms most noticeably in the formation of crystals. Many chemical changes are irreversible, and many physical changes are reversible, but reversibility is not a certain criterion for classification. Although chemical changes may be recognized by an indication such as odour, colour change, or production of a gas, every one of these indicators can result from physical change.

In general, a physical change is reversible using physical means. For example salt dissolved in water can be recovered by allowing the water to evaporate.

Physical changes are attributed to:

1. **Phase change.** This involves moving between solid, liquid and gas involves only the amount of energy in the sample. There is no effect on the chemical identity of the substance. For example, water remains water, no matter if it solid, liquid or gas.
2. **Grinding something into a powder.** Or the reverse process of making a bigger lump of stuff, say by melting lots of small pellets of copper into one big piece.
3. **Magnetisation.** This change in no way affects the chemical identity of the element. Iron that is magnetized rusts just as easily as iron that is not magnetized.

Table 1.4: Processes involved in change of phases of matter

Change	Name of change
Solid to liquid	melting, fusion
Liquid to gas	boiling, evaporation
Solid to gas	sublimation
Gas to solid	deposition
Gas to liquid	condensation, liquefaction
Liquid to solid	freezing, solidification

The change of state from solid to liquid is called melting or fusion, while the reverse process is called freezing or solidifying. The melting point is the temperature at which a substance changes from solid to liquid. Conversely, freezing point is the temperature at which a substance changes from a liquid to solid. These two temperatures are essentially the same – which one is used depends upon whether the substance is being heated or being cooled.

The change of state from liquid to gas is called vaporisation or boiling, while the reverse process is called condensation. The boiling point is the temperature at which a substance changes from liquid to gas. Conversely, condensing point is the temperature at which a substance changes from a gas to liquid. When liquids gradually turn into gases at temperatures less than their boiling point, the process is called evaporation.

Some substances, like iodine and solid carbon dioxide, can go directly from solid to gaseous state without melting – this is known as sublimation. The reverse process of sublimation is called deposition.

Chemical Changes

A chemical change means that the reacting compound(s) are changed into new compounds. The actual atoms involved remain, but are simply rearranged into the new compounds. The rearrangement is called a chemical reaction.

For example:

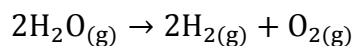

is a chemical reaction in which water is broken down into the hydrogen and oxygen which make it up. Notice how the amounts of hydrogen atoms (four) and oxygen atoms (two) do not change from one side of the arrow to the other. However, the arrangement of the atoms is different. Some chemical bonds (the one involved in the water) have been broken and some new chemical bonds (the one in hydrogen and oxygen) have been formed.

Thus, a chemical change is a process in which chemical bonds are broken and new ones are made. A process like grinding some salt crystals into a fine powder does not involve the breaking of chemical bonds and the formation of new ones, so it is a physical change. A chemical change always involves a change in the chemical relationship between the various substances involved. This change is seen in the fact that some chemical bonds are broken and some bonds are newly made.

Another example of a chemical change is:

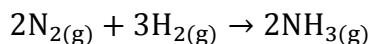

While all three substances are gases, the two reacting substances are quite different chemically from the product. This is because the bonds between the nitrogen atoms have been broken, as well as between the hydrogen atoms. In the place of these broken bonds has come something not present in the reactants, bonding between a nitrogen atom and some hydrogen atoms.

1.3 Separation of Mixtures

Most materials found in nature are in the form of mixtures. A separation process is used to transform a mixture into two or more distinct products. Components of mixtures are usually separated by physical means to give their purified forms. There are different physical methods which can be employed to separate mixtures. The particular technique chosen for any given mixture depends on the nature of the constituents.

This is done by considering that different components of the mixture may have different properties such as:

- size
- density
- solubility
- electrical charge
- boiling point

Depending on the raw mixture, various processes can be employed to separate the mixtures. Often, two or more of these processes must be used in combination to obtain the desired separation.

Evaporation

This method is used to separate components of soluble solid/liquid mixtures and volatile/non-volatile liquid mixtures. The principle governing this method is the fact that molecules of liquid substances when they gain heat, become gaseous and are lost from the surface. Note that the liquid, having vaporized is not collected but lost to the atmosphere. The other component (which is required), is then collected. An example is a mixture of sodium chloride and water.

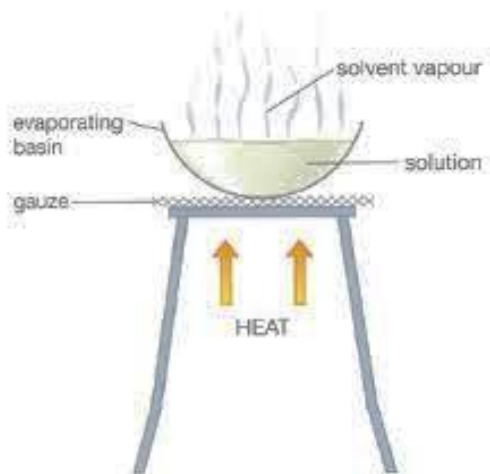

Figure 1.3: Evaporation process

Distillation

This is used to separate components of liquid/liquid mixtures and soluble solid/liquid mixtures. It involves heating the mixture, and the vapour formed is allowed to cool, liquefy and is collected as pure liquid. Thus, each component of the mixture is purified. The principle behind this method is based on the fact that when liquids are heated to their boiling points, they become gaseous, and when the gases are cooled, they change back to the liquid.

It is worthy of note that while evaporation is mostly used for solid/liquid mixtures, distillation is mostly used to separate liquid/liquid mixtures. Both evaporation and distillation involve gain of heat, and then vaporization. In evaporation, the vapour formed is allowed to escape into the atmosphere, while in distillation, the vapour is not lost but cooled, liquefied and collected as pure liquid. Distillation is used to purify solvents. There are two kinds of distillation – simple and fractional distillation.

Simple Distillation

This is used to separate mixtures of volatile/non-volatile liquids, or for mixtures of liquids whose boiling points are wide apart (by at least 100 °C). In other words, simple distillation is a method used for the separation of components of a mixture containing two miscible liquids that boil without decomposition and have sufficient difference in their boiling points. Examples of such mixtures are the mixture of water and ink, acetone and water. Simple distillation is applicable in the distillation of alcohol.

The distillation process involves heating a liquid to its boiling points, and transferring the vapours into the cold portion of the apparatus, then condensing the vapours and collecting the condensed liquid in a container. In this process, when the temperature of a liquid rises, the vapour pressure of the liquid increases. When the vapour pressure of the liquid and the atmospheric pressure reach the same level, the liquid passes into its vapour state. The vapours pass over the heated portion of the apparatus until they come into contact with the cold surface of the water-cooled condenser. When the vapour cools, it condenses and passes down the condenser and is collected into a receiver through the vacuum adapter.

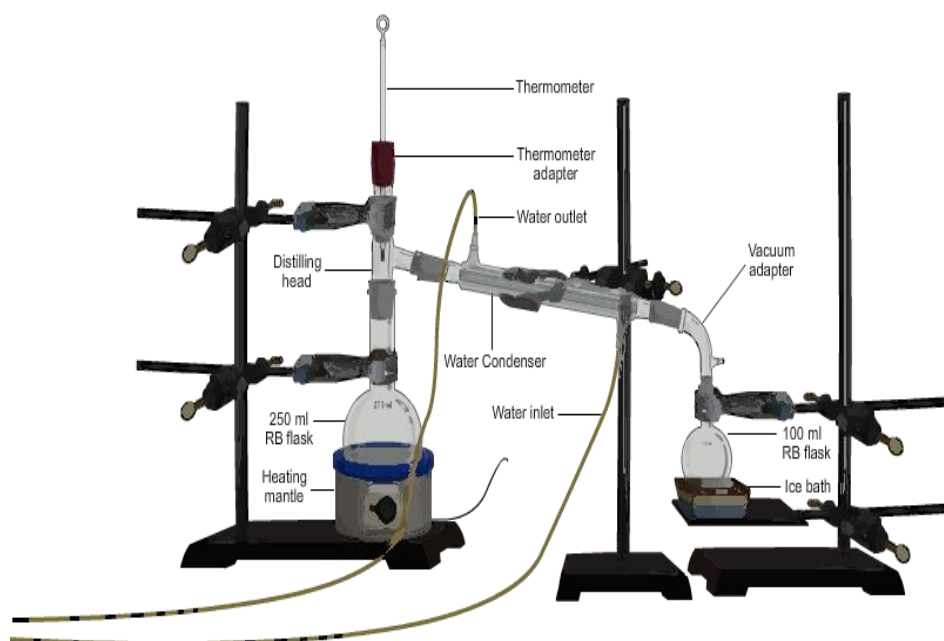

Figure 1.4: Simple distillation set-up

Fractional Distillation

This is used to separate a mixture of liquids whose boiling points are close (boiling point difference of not more than 20-30°C). Examples of mixtures that can be separated by this method include: petroleum; alcohol and water; liquid air (a mixture of oxygen (b.pt 90 K), nitrogen (b.pt 77 K) and water (b.pt 100°C)). The apparatus for fractional distillation is similar to that of simple distillation, except that a fractionating column is fitted in between the distillation flask and the condenser.

A simple fractionating column is a tube packed with glass beads. The beads provide surface for the vapours to cool and condense repeatedly. When vapours of a mixture are passed through the fractionating column, because of the repeated condensation and evaporation, the vapours of the liquid with the lower boiling point first pass out of the fractionating

column, condense and are collected in the receiver flask. The other liquid, with a slightly higher boiling point, can be collected in similar fashion in another receiver flask.

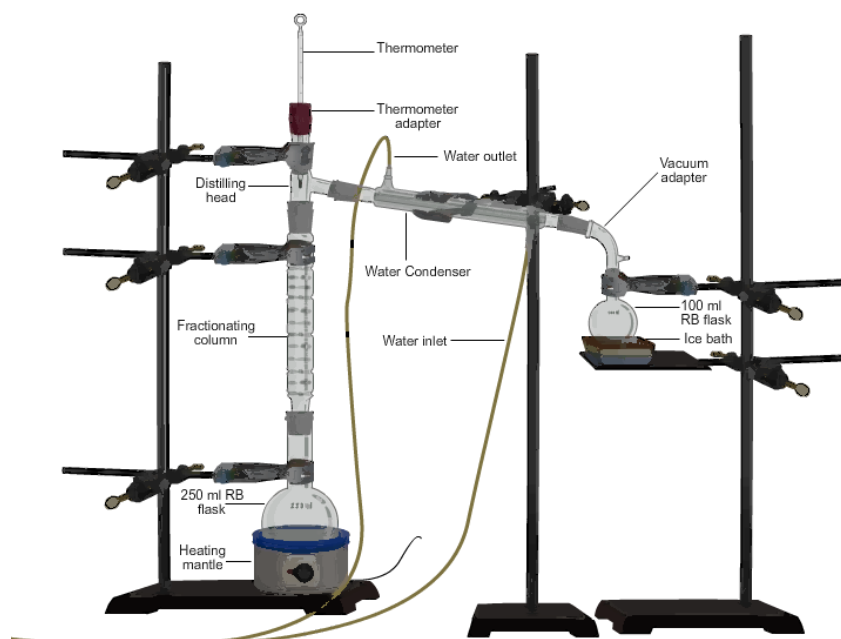

Figure 1.5: A simple fractionating column

Fractional distillation process is application in the separation of different fractions from petroleum products and separation of a mixture of methanol and ethanol.

Sublimation

Sublimation is suitable for solid mixtures containing solid substances that can vaporize directly when heated. Examples of such substances are iodine crystals, ammonium chloride, anhydrous aluminium chloride, anhydrous iron (III) chloride

and benzoic acid. The vapour is cooled away from the other component(s) and collected as solid.



Figure 1.6: Sublimation set-up

Dissolution

The principle behind this technique is that some solid substances are soluble in certain kind of solvent, while others are not. Hence, it is used generally to separate soluble substances from insoluble ones. For example, a mixture of sodium chloride crystals and sand – the sodium chloride is soluble in water while sand is not. Therefore, water is added to the mixture to dissolve sodium chloride while leaving the sand to settle.

Organic solvents generally dissolve organic substances, e.g. kerosene dissolves wax, grease, fats and oils. Inorganic solvents dissolve inorganic substances, and ionic solvents dissolve ionic substances. Common solvents for sulphur are:

carbon (IV) sulphide, CS_2 and methylbenzene (toluene). Common solvents for iodine are: ether (ethoxyethane), alcohol, carbon tetrachloride, CCl_4 and potassium iodide.

Water soluble salts include all common trioxonitrates (V) of metals; all common salts of sodium, potassium and ammonium; all common tetraoxosulphates (VI), (except, barium tetraoxosulphate (VI) and lead (II) tetraoxosulphate (VI), and calcium tetraoxosulphate (VI) is sparingly soluble); and all common chlorides except those of silver, mercury (I) and lead.

Filtration

This is used to separate liquid components of mixtures from the solid components (which are in suspension). The principle of this technique is that the particles of liquid are small enough to pass through the filter material while those of solids are not. This implies that the solid particles are in suspension. If they were settled at the bottom, then the process would be decantation and not filtration. Decantation does not involve the use of filter materials; it is the run-off of the liquid component, leaving the solid behind. Decantation will come before filtration (depending on whether the mixture contains solid components which are large and heavy enough to settle).

Both filtration and decantation usually follow the process of dissolution. For instance, after the sodium chloride component of a mixture of sodium chloride and sand is dissolved in water, the liquid component (sodium chloride solution) is decanted (separation from sand), and then filtered to obtain clear sodium chloride solution.

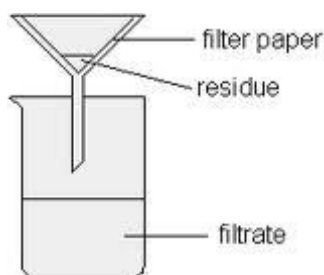

Figure 1.7: Simple filtration process

Crystallization

The principle of this method is based on the fact that soluble salts are only soluble to certain concentrations at a given temperature. Decrease in the temperature of their saturated solutions will see the salts forming out of the solution. It is used to obtain a soluble salt from its solution, and it involves heating the solution up to the point of saturation (for salts which crystallize with water of crystallization, e.g., $\text{ZnSO}_4 \cdot 7\text{H}_2\text{O}$). Cooling the solution below this point results in the formation of the crystals from the solution.

For salts which do not crystallize with water, such as NaCl , their solutions are heated to dryness to produce them. The salts which crystallize with water are not heated to dryness, otherwise, their crystalline nature will be lost. To purify further, the salt can be recrystallized, that is, the crystals obtained is dissolved in hot distilled water and the process of crystallization is repeated.

It is noteworthy that crystallization needs evaporation (by heating) for the solution to become saturated. It is possible to separate a mixture of more than one water-soluble salt by crystallization. This is because the solutions of different substances attain saturation at different temperatures. A solution containing a mixture of different substances therefore crystallizes its components separately when cooled below the saturated points of the different components in solution - this is known as fractional crystallization.

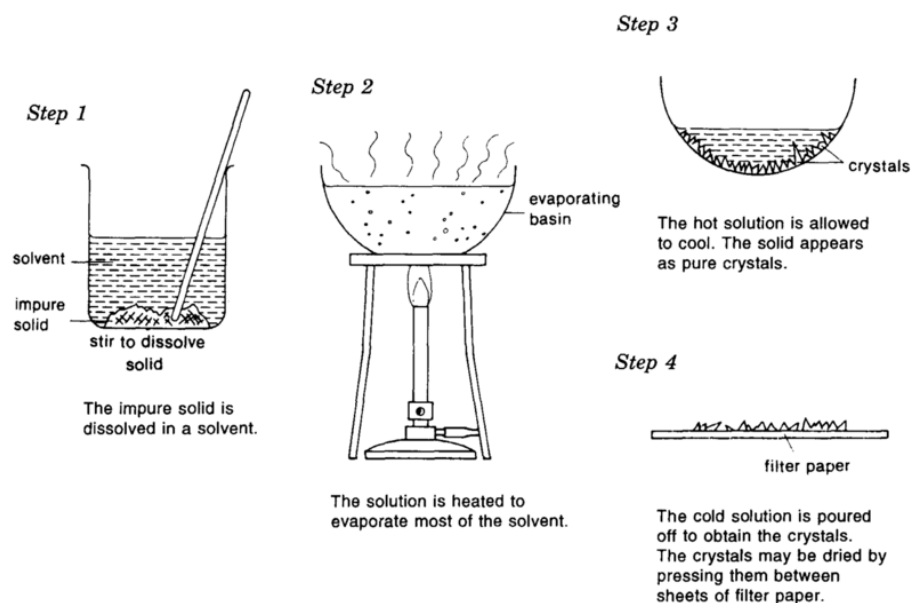

Figure 1.8: Schematic diagram of crystallisation process

Chromatography

This method is mostly popular for the separation of coloured components of pigments (e.g. ink and paints). However, it is useful also in separating certain non-coloured components of mixtures. All chromatographic methods involve two phases, namely: stationary phase and mobile phase. Separation is based on the relative speed of the components of the mixture in-between the two phases.

If the stationary phase is a solid, the process is called adsorption chromatography. If the stationary phase is a liquid, the process is called partition chromatography.

Column Chromatography (Adsorption Chromatography)

The stationary (adsorbent) is a solid such as finely divided alumina and silica gel. The column is usually a glass tube with

a tap at the bottom packed with the adsorbent and the mobile phase (the eluting solvent).

As the solvent travels down the column, it carries with it the different components, which travel down at different rates depending on the extent to which they are adsorbed. More strongly adsorbed components travel down more slowly than less adsorbed ones. Hence, components are separated based on their different degree of adsorption on to the stationary phase as they move down the column (which causes them to move at different speeds).

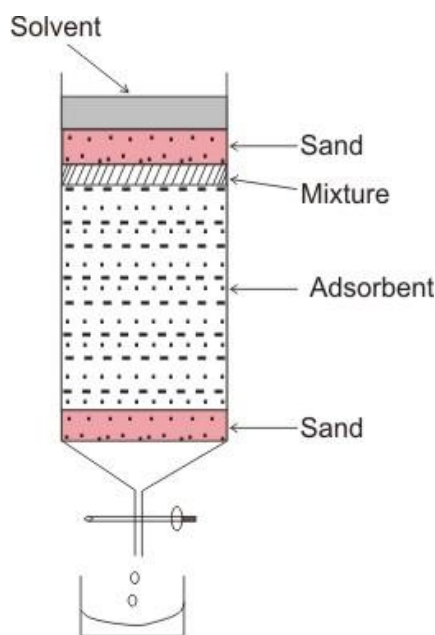

Figure 1.9: Column chromatography set-up

Paper Chromatography (Partition Chromatography)

Paper chromatography, also known as partition chromatography is a technique that involves the use of strips of filter paper. Notice that the stationary phase in paper chromatography is the moisture in the paper, and not the paper

itself. This is an example of partition chromatography. Separation depends on the different degree of motion (i.e. speed) of the components of the mixture between the stationary water phase and the mobile chromatographic solvent (due to the different affinity the components have for both the stationary and mobile phases).

The material to be separated is applied as a spot near the bottom of the strip of paper. It is dipped into the solvent and the chromatogram left to develop. The solvent (e.g. propanone or ethanol) ascend the strip of paper by capillary action, and carries the solute along with it, different components travel at different rates depending on their relative affinity for both the mobile and stationary phases.

This is ascending paper chromatography. A descending technique can be made by allowing the solvent to flow down the strip from a tray containing the solvent. Components of mixtures with greater affinity for the mobile phase than the stationary phase are separated first.

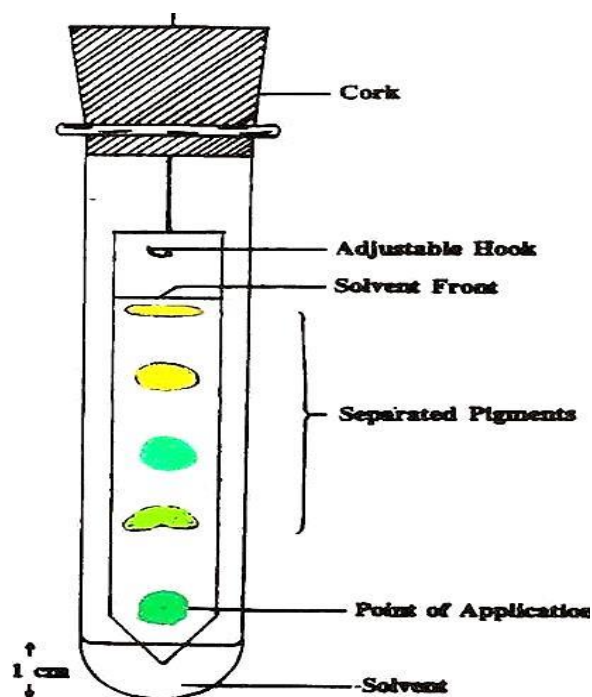

Figure 1.10: Ascending paper chromatography set-up

Precipitation

Precipitation is used to separate a salt which is soluble in one solvent, forming a mixture with that solvent, but become insoluble when another liquid which mixes well with the mixture but which does not dissolve the salt is added. The salt will therefore be precipitated from the solution and collected by filtration. For example, iron (II) tetraoxosulphate (VI) is soluble in water to form a mixture (i.e. a solution). When ethanol is added to the solution (ethanol is miscible with water), the iron (II) tetraoxosulphate (VI) will be precipitated from the solution as it is insoluble in ethanol.

Sieving

Sieving is used to separate solid mixtures whose components' particle sizes differ greatly. A sieve is used to make the separation. The particles of one component are small enough to pass through the sieve, while those of the other are not, and are therefore held onto the sieve, separated from the first. Notice that the principle of separation used here is the large difference in the particle size of the components of the mixture.

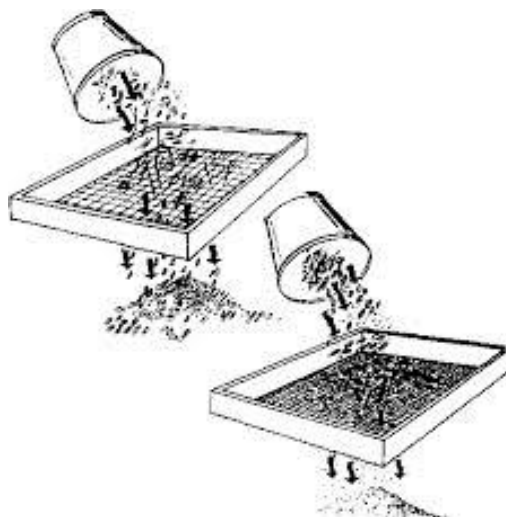

Figure 1.11: A simple sieving process

Separating Funnel

It is used for the separation of components of a mixture between two immiscible liquid phases. One phase is the aqueous phase and the other phase is an organic solvent. This separation is based on the differences in the densities of the liquids. The liquid having more density forms the lower layer and the liquid having less density forms the upper layer. Applications of separating funnel include separating a mixture of oil and water, and a mixture of kerosene oil and water.

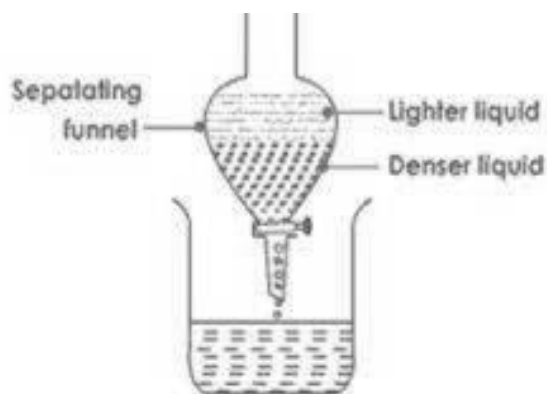

Figure 1.12: Separating funnel

Centrifugation

Sometimes the solid particles in a liquid are very small and can pass through a filter paper. For such particles, the filtration technique cannot be used for separation. Such mixtures are separated by centrifugation. So, centrifugation is the process of separation of insoluble materials from a liquid where normal filtration does not work well. The centrifugation is based on the size, shape, and density of the particles, viscosity of the medium, and the speed of rotation. The principle is that the denser particles are forced to the bottom and the lighter particles stay at the top when spun rapidly.

The apparatus used for centrifugation is called a centrifuge. The centrifuge consists of a centrifuge tube holder called rotor. The rotor holds balanced centrifugal tubes of equal amounts of the solid-liquid mixture. On rapid rotation of the rotor, the centrifuge tubes rotate horizontally and due to the centrifugal force, the denser insoluble particles separate from the liquid. When the rotation stops, the solid particles end up at the bottom of the centrifuge tube with liquid at the top.

Applications of centrifugation include:

1. Used in diagnostic laboratories for blood and urine tests.
2. Used in dairies and home to separate butter from cream.

3. Used in washing machines to squeeze water from wet clothes.

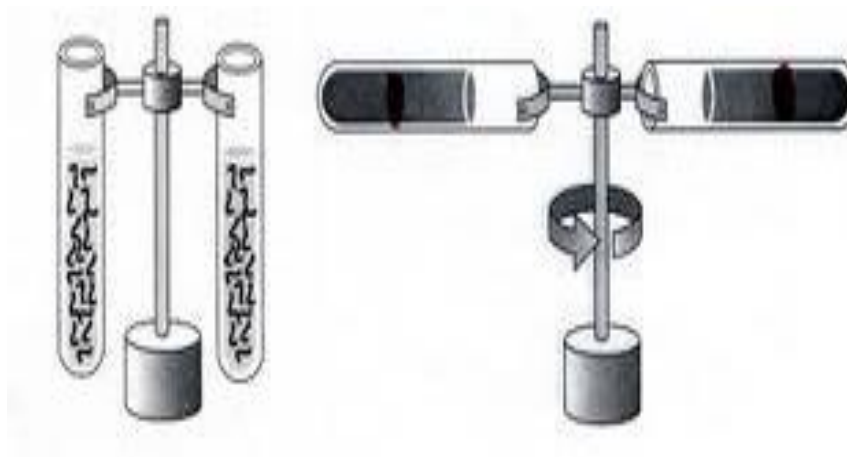

Figure 1.13: A Simple centrifugation process

Questions

1. Identify the following states of matter:
 - a. The volume is constant but does not depend on shape
 - b. The particles are moving and colliding at the fastest rate
 - c. Particle movement is restricted to the volume
 - d. In this state of matter volume does not vary as temperature increases
2. True/False
 - a. Water is the only compound to be found in all three principal states of matter?
 - b. Chemical changes lead to the different states of matter in water?

- c. During the variations between the different states, matter is lost?
 - d. Solid, liquid, and gas are the only states of matter?
3. In the followings, identify which is an element and which is a compound. (a) Silver metal (b) Table salt (c) Oxygen gas (d) Stainless steel (e) Iron.
 4. Classify each of the following as homogeneous or heterogeneous mixture (a) Wine (b) Chicken soup (c) Unopened Carbonated soda (d) Creamy peanut butter (e) Minestrone soup.
 5. Classify each of the following as an element, compound, or a mixture (a) Gold ring on your finger (b) Sugar (e) French salad dressing (d) Helium (e) Sand.
 6. Label each process as a physical or chemical change: (a) perfume evaporating on your skin (b) butter melting (c) wood rotting (d) charcoal heating a grill (e) a hot glass cracking when placed in cold water (f) melting copper metal (g) burning sugar (h) mixing sugar in water (i) digesting food.
 7. Which of the following would NOT be a physical change?
(a) freezing water to make ice cubes (b) melting gold to make jewelry (c) burning gasoline in a lawnmower (d) boiling water for soup (e) tearing a piece of aluminum foil
 8. Which of the following is NOT a physical change?
(a) grating cheese (b) melting cheese (c) fermenting of cheese (d) mixing two cheeses in a bowl
 9. Which are physical and which are chemical changes?
(a) boil (b) burn (combustion) (c) condense (d) corrode (e) crumple (f) ferment (g) melt (h) rust (i) crush (j) freeze (k) oxidize (l) tarnish (m) explode (n) grind (o) rot (p) vaporize (q) photosynthesis (r) sublimation

10. If a certain mixture is homogeneous, you would properly conclude that the physical properties and the composition:
(a) are different from one part of the sample to another (b) vary smoothly from top to bottom of the sample (c) are the same in every small volume element from the sample (d) none of these
11. Label each process as a physical or chemical change: (a) hydrofluoric acid attacks glass (used to etch glassware) (b) A chef making a sauce with brandy is able to burn off the alcohol from the brandy, leaving just the brandy flavouring (c) Chlorine gas liquefies at $-35\text{ }^{\circ}\text{C}$ under normal pressure (d) hydrogen burns in chlorine gas
12. Label each process as a physical or chemical change: (a) fogging a mirror with your breath (b) breaking a bone (c) mending a broken bone (d) burning paper (e) slicing potatoes for fries (f) mixing sugar with coffee (g) frying chicken (h) a nail rusting (i) paper ripping (j) wood burning (k) mixing water and food colouring (l) food molding (rotting) (m) writing on paper (n) dyeing fabric
13. Is concrete a heterogeneous mixture?

CHAPTER TWO

2.0 Atoms and Molecules

An atom is the smallest indivisible particle of an element according to Dalton's theory.

This assumption about the indivisibility of atom has been found to be incorrect (Ref. Modifications of Dalton's atomic theory).

J.J. Thompson was among numerous scientists that performed experiments to determine the components and structure of the atom by using cathode ray tube.

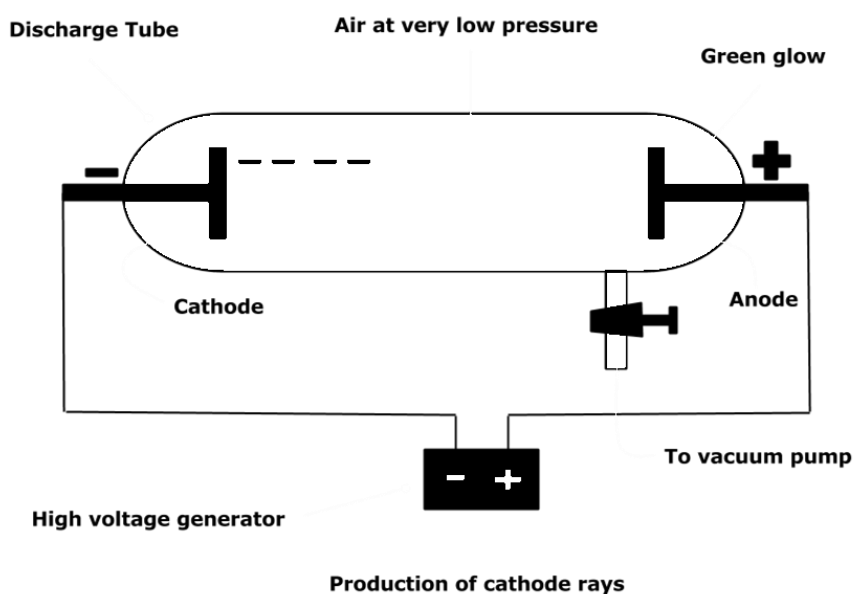

Figure 2.1: J.J. Thomson's Cathode ray tube

The results of the experiment demonstrated that:

- (i) The cathode rays cause the fluorescent screen to glow with green light when the rays fall on it.

- (ii) The rays are bent towards the positive electrode when an electric field is placed on their path.
- (iii) A magnetic field has a similar effect on the rays as the electric field.
- (iv) An object placed behind the perforated anode casts a shadow on the screen.
- (v) The rays penetrated sheets of metal as 1mm thick aluminium without casting a shadow.
- (vi) The rays can impart mechanical motion on a tiny paddle wheel.

The explanations to the above observations are as follows:

- (i) The bending of the rays by both electric and magnetic fields suggest that cathode rays are negatively charged particles.
- (ii) The casting of the shadow of an object in their path on the screen shows that the rays travel in straight line.
- (iii) That the cathode rays can pass through aluminium foil indicates that they are smaller particles than atoms.
- (iv) They are able to rotate a paddle wheel because they are particles, which possess some mass (though negligible).
- (v) The constant mass and charge of the particles irrespective of the nature of the cathode or the residual gas proves that they are basic constituents of matter. These particles are called electrons.

Millikan subsequently determined the charges of an electron in his famous “oil drop experiment.” Although $\frac{e}{m}$ ratio for electron was deduced by J.J. Thomson’s Cathode Ray Tube experiment, Robert Millikan designed an experiment to measure the absolute value of the charge of electron.

In 1909, American physicist R. Millikan measured the charge of an electron using negatively charged oil droplets. The measured charge (e) of an electron is -1.60×10^{-19} Coulombs.

Using the measured charge of electron, we can calculate the mass of electron from e/m ratio given by J.J. Thomson's cathode ray experiment.

$$\frac{e}{m} = -1.76 \times 10^8 \text{ Coulomb/gram}$$

$$m = \frac{e}{-1.76 \times 10^8}$$

Putting $e = -1.60 \times 10^{-19}$ Coulomb,

$$m = 9.1 \times 10^{-28} \text{ gram}$$

Earlier, in an experiment done by Faraday in an effort to discover electron, it can be deduced that 1 coulomb of charge will liberate the electrochemical equivalent of an electrolyte. It can therefore be said that 1 mole of electrolyte can be liberated by the expression:

$$1 \text{ mole of electron} = \frac{\text{Mass of a mole of electrolyte}}{\text{Electrochemical equivalent}}$$

Example 1

If Z chemical equivalent for Ag is $111.8 \times 10^{-8} \text{ kgc}^{-1}$ and the chemical equivalent for Ag is 107.8. Then the amount of charge required to liberate 107.8 kg of Ag is given by:

$$\frac{107.8}{111.8 \times 10^{-8}} = 96478$$

For Cu, if Z is 32.9×10^{-8} and equivalent for Cu is 32 kg then, the amount of charge required to liberate 32 kg of Cu is given by:

$$\frac{32}{32.9 \times 10^{-8}} = 97264$$

These values, 96478 and 97264 represent the amount of charge in coulomb that liberate 1 g equivalent of Cu. Very accurate values of these kinds of experiment show that 96500 is the amount of charge that would liberate 1 Avogadro number of monoatomic electrolyte from solution. The Avogadro's number is 6.023×10^{23} .

Therefore, the charge carried by one atom in Avogadro's number of particles is given by:

$$\frac{96500}{6.023 \times 10^{23}} = 1.6 \times 10^{-19}$$

This value 1.6×10^{-19} is the amount of charge carried by 1 atom. The particle which carries this amount of charge in an atom is called the electrons. This is the origin of the word, Electron.

2.1 Cathode Rays

Here, Electricity is passed through gaseous elements in a discharge tube. At normal pressures (760 mm Hg), nothing was observed in the discharge tube. But when the pressure in the discharge tube is reduced to 100 mmHg, there was some luminous glow seen. When the pressure is reduced still further, values between (10–100) mmHg, streams of bright lines are seen stretching from the cathode end to the anode. These lines are rays and are known as the cathode rays.

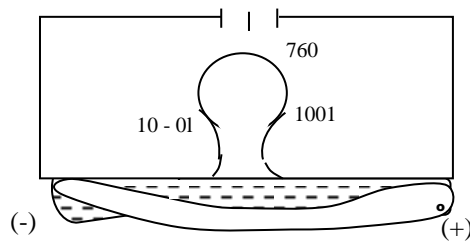

Figure 2.2: Discharge Tube Experiment

2.2 Millikan's Oil Drop Experiment

Small droplets of oil from an atomizer were blown between two parallel plates and the rate of fall of one of these droplets under gravity was observed; from which its weight can be calculated. The oil is charged by spraying the air space by X-rays. By applying potential across the plates, the motion of the oil drop can be varied. The speed of the droplet can be related to its weight, the magnitude of the electric field and from the charge it picks up, the value of this charge can be determined. Millikan observed that droplets of oil can pick up several different charges but the total charge was always an exact integral multiple of the smallest charge (1.602×10^{-19}) coulomb.

The equation he used was:

$$\begin{aligned} & \text{Electric field intensity} \times \text{Charge on oil drop} \\ & = \text{Mass of oil drop} - \text{Upthrust on oil drop} \end{aligned}$$

2.3 Rutherford Experiment

In this experiment a thin parallel beam of alpha (α) particles directed onto a thin strip of gold and the subsequent curve of the particles was determined. Some particles were deflected off

course and diverge; but the majority passes straight through the gold strip with little or no disturbance. On increasing the thickness of the gold strip, more and more of the alpha particle suffer the same fate.

Rutherford reasoned that the large angle scattering of the alpha particles must be due to a collision or a near collision with an incredibly small nucleus, which carried a positive charge approximately equal to half the atomic weight of the atom, and assumed all the mass to be residing in the center (nucleus).

The atom was visualized as containing a small positive nucleus where practically all the mass resided. Around this nucleus was a diffuse region containing sufficient number of electrons to maintain electrical neutrality.

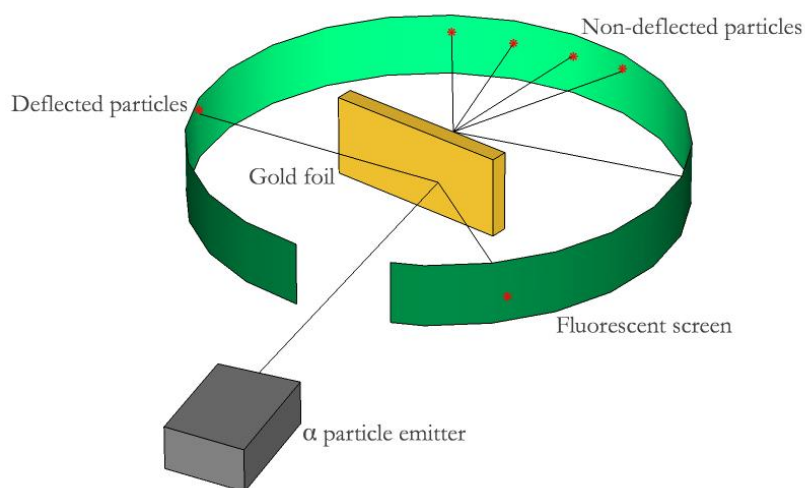

Figure 2.3: Interaction of α -rays with gold atoms

Rutherford proposed the model in Fig. 2.4 as the structure of an atom.

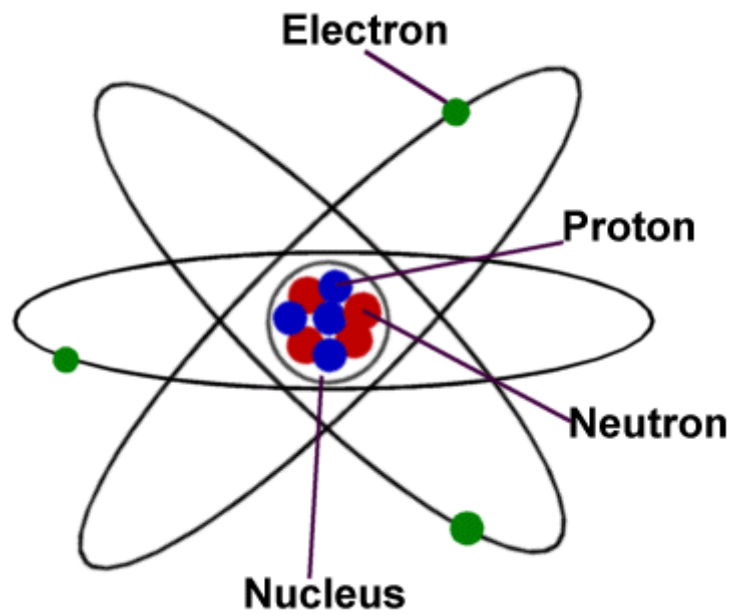

Figure 2.4: Rutherford's Model of an Atom

2.4 Moseley Experiment on Atomic Number

Moseley in 1913 found that X-ray spectra consisted of groups of lines. Each line represented a definite wavelength. They occurred at regular intervals when elements with increasing atomic masses were used as targets. With Mg as target, there was a line at a wavelength of 0.21 nm; Fe had 0.193 nm and 0.179 nm for cobalt as target.

The interpretation of these results was that there is a fundamental property of the atoms of the element, which increases regularly as the atomic number increases. Moseley thought this property was the number of protons in the nucleus of each atom. Thus, this experiment showed that the elements

arose by a stepwise addition of one proton to the nucleus of a preceding one.

2.5 Determination of Relative Atomic and Molecular Masses: The Mass Spectrometer

The mass spectrometer is a modern instrument used for measuring the relative masses of atoms and molecules of compounds. In a mass spectrometer, a stream of electron is passed at high speed through the gaseous atom of an element that causes electrons to be struck off from the outermost shells of the atoms, producing positively charged ions. The ions so produced are then accelerated by an electric field in a discharge tube. On getting to a magnetic field further away from their source, the paths of the ions are bent. The extent to which each ion path is bent depends solely on its mass provided all the ions are traveling with the same speed and carry equal charges. The lightest ions are bent to the greatest extent and the heaviest to the least extent. A line is inscribed on the detector plate where ions of the same mass strike it. The intensity of each line depicts the relative abundance of ions of that mass.

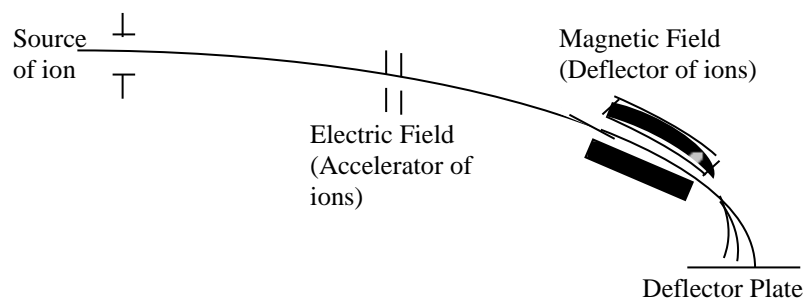

Figure 2.5: Schematic diagram of mass spectrometer

When a single element is injected into the mass spectrometer, several lines are often produced on the detector plate. Oxygen for example, produces three lines corresponding to masses 16, 17 and 18. The line for mass 16 is the most intense. These for masses 17 and 18 are less intense.



Figure 2.6: Lines on a detector plate when oxygen is used

The explanation for atoms of the same element falling at different point on the detector plate is that such atoms have different masses. Atoms of the same element with different masses are called isotopes. Chlorine occurs as two isotopes ^{35}Cl (75%) and ^{37}Cl (25%). How many lines will appear on the detector plate if chlorine is injected into the mass spectrometer? Which isotope will give the more intense line? Calculate the relative atomic mass of chlorine.

2.6 Niels Bohr's Theory

Niels Bohr proposed in 1913 that electrons move round the nuclei of atoms in orbits (or shell) and attributed centrifugal force to the reason why electrons in an atom are not attracted to the positively charged nuclei.

However, this theory was not able to explain all the characteristics of atom e.g. atomic spectra emissions.

Atomic Spectra

Absorption Spectrum

If hydrogen gas is put into a discharge tube at low pressure and electric current at high voltage is passed through the metal plates at opposite ends of a tube, a pale-blue coloured light is observed. If this light is passed through a prism as shown in Fig. 2.7, a line spectrum made up of black lines on a white screen is obtained.

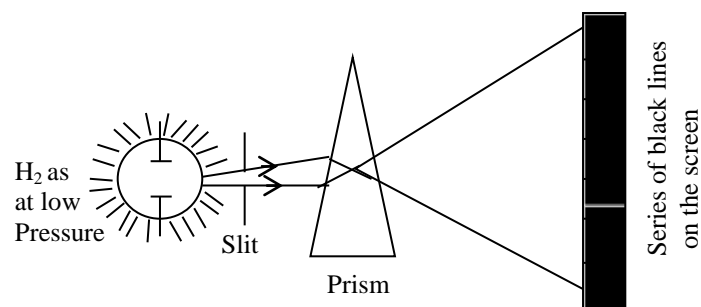

Figure 2.7: Apparatus for getting the hydrogen absorption spectrum

This is the absorption spectrum of hydrogen indicating the missing wavelengths of white light, which are responsible for the black lines.

The explanation for the missing wavelength is that electrons in hydrogen atoms absorb photons of energy from white light and jump to shells of higher energy level. The light reaching the screen has thus lost the absorbed wavelengths.

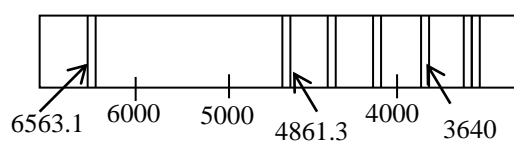

Figure 2.8: Hydrogen Absorption Spectrum

Emission Spectrum

If the same discharge tube is used as a source of light, the spectrum again consists of lines. These are bright lines on a dark background.

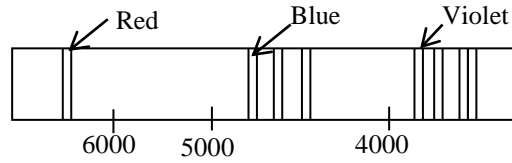

Figure 2.9: Hydrogen emission spectrum

This is an emission spectrum. The wavelengths that were missing from the absorption spectrum are the one present in the emission spectrum. On return to their lower energy levels, the electrons that jumped to shells of higher energies now emit photons of light corresponding in energy to what they absorbed. The emission appear on the screen as bright colours. This is why wavelengths missing in the absorption spectrum are the ones appearing in the emission spectrum.

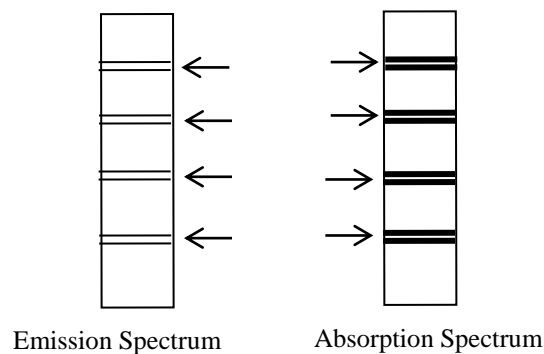

Figure 2.10: Missing wavelengths in an absorption spectrum appear in emission spectrum

When all electrons in an atom are in their lowest energy levels, the atom is said to be in ground state. When they absorb some photons of light and jump into shells of higher energy levels, the atom is said to be excited.

The Spectrum of the Hydrogen Atom

The hydrogen atom has a single electron in the K shell. If it absorbs a photon of light to move into a higher energy level, we should expect a single black line in its absorption spectrum. When this electron returns to the ground state it should give rise to a single colour or line in the emission spectrum, corresponding to the missing wavelength of the absorption spectrum. But in practice, a complex spectrum consisting of several lines is obtained (see Fig. 2.9 and 2.10). The Complex Spectrum of hydrogen can be explained as follows: A sample of hydrogen vapour contains many molecules, which are made up of two atoms each. The single electron of each atom is capable of absorbing and re-emitting different number of photons of energy. While some absorb enough energy to go into the L shell, other absorbs enough to take them into the M, N, O, etc. shells. The appropriate wavelengths are found missing in the hydrogen absorption spectrum. Similarly, the wavelengths of the radiation they re-emit will correspond to the different energies absorbed. The energy difference can be calculated from the equation:

$$E = h\nu \text{ or } E_2 - E_1 = h\nu$$

where, h, Planck constant = 6.626×10^{-34} Js and ν = frequency

Since the invention of the spectrometer to analyse light, the light source from hydrogen gas has been intensely studied. Lines were observed in the infrared, visible, and ultraviolet regions. The wavelengths or frequencies of these lines had been known for a long time.

Table 2.1: The frequency, wave number and wavelength of some of the lines in the visible region

Frequency (10^{14} Hz)	Wavelength (nm)	Wave number (number/m)	Energy (10^{-19} J)
4.57	656.3	1523	3.028
6.17	486.1	2056	4.088
6.91	434.0	2303	4.578
7.32	410.2	2437	4.845
7.56	397.0	2518	5.006
7.71	388.9	2571	5.110
7.82	383.5	2606	5.181

Electrons can only exist in certain areas around the nucleus called shells. Each shell corresponds to a specific energy level which is designated by a quantum number n . Since electrons cannot exist between energy levels, the quantum number n is always an integer value ($n=1,2,3,4\dots$). The electron with the lowest energy level ($n=1$) is the closest to the nucleus. An electron occupying its lowest energy level is said to be in the ground state.

The energy of an electron in a certain energy level can be found by the equation:

$$\frac{R_H}{n^2} = E$$

where, R_H is the Rydberg constant, n an integer, and K some constant

According to Bohr's derivation, the energy of the photons of these lines varies according to:

$$E = -R_H \left(\frac{1}{n^2} - \frac{1}{4} \right)$$

and $R_H = 2.179 \times 10^{-18} J$, is the Rydberg constant.

Depending on the units used for R_H , the energy E of this formula can be wavenumbers or frequencies.

Furthermore, the formula also applies to lines of the hydrogen spectrum in the infrared and ultraviolet regions, if the 4 is replaced by the square of some other integer, n' . Thus, the formula has a general form of:

$$E = -R \left(\frac{1}{n^2} - \frac{1}{n'^2} \right)$$

Depending on the value of n' , we have the following series:

$n' = 1$, Lyman series (ultraviolet)

$n' = 2$, Balmer series (visible) Wavelength vary from 400 to 700 nm

$n' = 3$, Ritz-Paschen series (short wave infrared)

$n' = 4$, Pfund series (long wave infrared)

Thus, this formula agrees with all observed lines in the hydrogen spectrum. The above formula has been employed to calculate the spectra of the hydrogen atom.

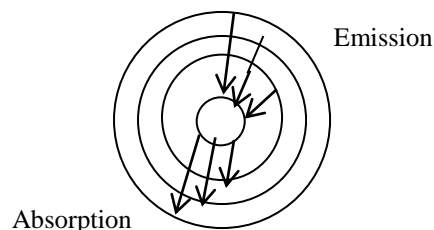

Figure 2.11: Energy levels of electrons and Bohr's explanation of the hydrogen spectrum

Example 2

A photon with a wavelength of 397nm is emitted from an electron in energy level 7 of a Hydrogen atom. What is the new energy level of the electron?

Solution

$$E_n = -\frac{R_H}{n^2}$$

$$E_7 = -\frac{2.179 \times 10^{-18}}{7^2}$$

$$E_n = -4.447 \times 10^{-20} \text{ J}$$

Then,

$$E_{\text{photon}} = \frac{hc}{\lambda}$$

$$E_{\text{photon}} = \frac{(6.62607 \times 10^{-34}) \times (3.0 \times 10^8)}{3.97 \times 10^{-7}}$$

$$E_{\text{photon}} = 5.0036 \times 10^{-19} \text{ J}$$

Then,

$$E_{n \text{ final}} = E_{n \text{ initial}} - E_{\text{photon}}$$

$$E_{n \text{ final}} = (-4.447 \times 10^{-20}) - (5.0036 \times 10^{-19}) \text{ J}$$

$$E_{n \text{ final}} = (-5.4483 \times 10^{-19}) \text{ J}$$

To figure out the energy level (n),

$$E_n = -\frac{R_H}{n^2}$$

$$E_n = -\frac{R_H}{n^2}$$

$$-5.4483 \times 10^{-19} = \frac{-2.179 \times 10^{-18}}{n^2}$$

Therefore, $n = 2$

2.7 Quantum Numbers

The spectra of atoms with many electrons are more complex than that of hydrogen. Each line is seemed to be composed of several very closely spaced lines. Schrodinger was able to explain the fine structures. Each shell was considered to be composed of a number of sub-energy levels.

Early models of the atom had electrons going around the nucleus in a random fashion. But as scientists discovered more about the atom, they found that this representation probably was not accurate. Today, scientists use the quantum mechanical model, a highly mathematical model, to represent the structure of the atom. This model is based on quantum theory, which says that matter also has properties associated with waves. According to quantum theory, its impossible to know an electron's exact position and momentum (speed and direction, multiplied by mass) at the same time. This is known as the uncertainty principle. So scientists had to develop the concept of orbitals (sometimes called electron clouds), volumes of space in which an electron is likely present. In other words, certainty was replaced with probability.

Four numbers, called quantum numbers, used to describe the characteristics of electrons and their orbitals are: (i) principal quantum number, n ; (ii) angular momentum quantum number, l ; (iii) magnetic quantum number, m_l and (iv) Spin quantum number, m_s

Table 2.2: Summary of the quantum numbers

Name	Symbol	Description	Allowed Values
Principal	n	Orbital energy	Positive integers (1, 2, 3, and so on)
Angular momentum	l	Orbital shape	Integers from 0 to $n-1$
Magnetic	m_l	Orientation	Integers from -1 to +1
Spin	m_s	Electron spin	$+\frac{1}{2}$ or $-\frac{1}{2}$

The Principal Quantum Number, n

The principal quantum number n describes the average distance of the orbital from the nucleus – and the energy of the electron in an atom. It can have only positive integer (whole number) values: 1, 2, 3, 4, and so on. The larger the value of n , the higher the energy and the larger the orbital, or electron shell.

The Angular Momentum Quantum Number, l

The angular momentum quantum number l describes the shape of the orbital, and the shape is limited by the principal quantum number, n : The angular momentum quantum number l can have positive integer values from 0 to $n-1$. For example, if the n value is 3, three values are allowed for l : 0, 1, and 2. The value of l defines the shape of the orbital, and the value of n defines the size. Orbitals that have the same value of n but different values of l are called *subshells*. These subshells are given different letters to help chemists distinguish them from each other.

Table 2.3: Letter designation of the subshell

Value of l (Subshell)	Letter
0	S
1	P
2	D
3	F
4	G

One particular subshell in an atom, is described by using both the n value and the subshell letter – 2p, 3d, and so on. Normally, a subshell value of 4 is the largest needed to describe a particular subshell. If chemists ever need a larger value, they can create subshell numbers and letters (Fig. 2.12).

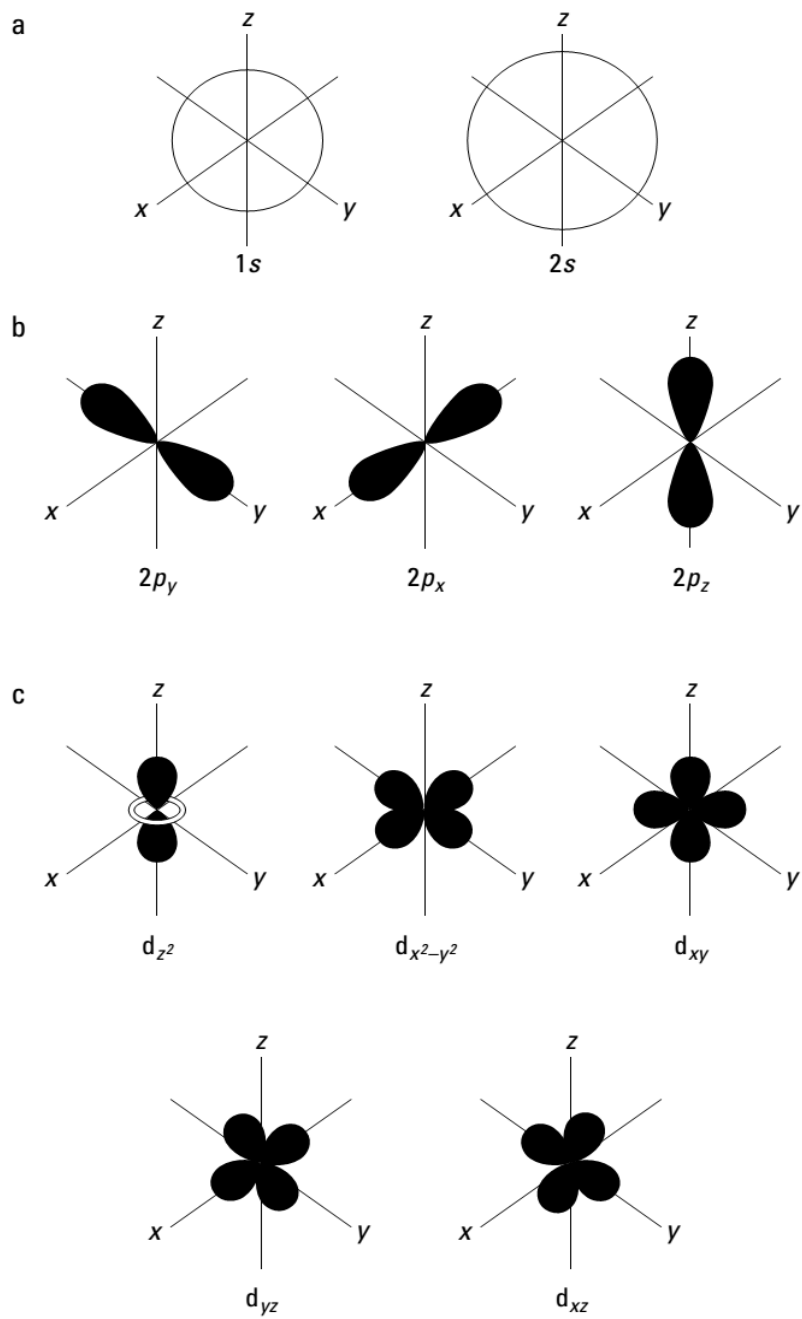

Figure 2.12: Shapes of s, p and d orbitals

The Magnetic Quantum Number, m_l

The magnetic quantum number, m_l describes how the various orbitals are oriented in space. The value of m_l depends on the value of l . The values allowed are integers from $-l$ to 0 to $+l$. For example, if the value of $l = 1$ (p orbital), you can write three values for m_l : -1 , 0 , and $+1$. This means that there are three different p subshells for a particular orbital. The subshells have the same energy but different orientations in space.

The Spin Quantum Number, m_s

The fourth and final quantum number is the spin quantum number, m_s . This one describes the direction the electron is spinning in a magnetic field – either clockwise or counter clockwise. Only two values are allowed for m_s : $+1/2$ or $-1/2$. For each subshell, there can be only two electrons, one with a spin of $+1/2$ and another with a spin of $-1/2$.

Table 2.4: Summary of the quantum numbers

Principal Quantum Number	Angular Momentum Quantum Number	Subshell Notation	Magnetic Quantum Number	Spin Quantum Number
1	0	1s	0	$+1/2, -1/2$
2	0	2s	0	$+1/2, -1/2$
	1	2p	-1 0 +1	$+1/2, -1/2$ $+1/2, -1/2$ $+1/2, -1/2$

In energy level 1 ($n = 1$), there is only an s orbital. There is no p orbital because an l value of 1 (p orbital) is not allowed. And notice that there can be only two electrons in that 1s orbital (m_s of $+1/2$ and $-1/2$). In fact, there can be only two electrons in any s orbital, whether it's 1s or 5s. Each time we move higher in a major energy level, there is addition of another orbital type. So when you move from energy level 1 to energy level 2 ($n = 2$), there can be both s and p orbitals. If we write out the quantum numbers for energy level 3, s, p, and d orbitals will be obtained.

Notice also that there are three subshells (m_l) for the 2p orbital and that each holds a maximum of two electrons. The three 2p subshells can hold a maximum of six electrons. There's an energy difference in the major energy levels (energy level 2 is higher in energy than energy level 1), but there's also a difference in the energies of the different orbitals within an energy level. At energy level 2, both s and p orbitals are present. But the 2s is lower in energy than the 2p. The three subshells of the 2p orbital have the same energy. Likewise, the five subshells of the d orbitals have the same energy.

Energy Level Diagrams

Energy level diagrams and electron configurations are used to represent which energy level, subshell, and orbital are occupied by electrons in any particular atom. Chemists use this information to predict what type of bonding will occur with a particular element and to show exactly which electrons are being used. These representations are also useful in showing why certain elements behave in similar ways.

These can be illustrated with energy level diagram of oxygen. Figure 2.13 represents a blank energy level diagram, which does not show the known orbitals and subshells. The orbitals are represented with dashes in which a maximum of two electrons can be placed. The 1s orbital is closest to the nucleus, and it has the lowest energy. It is also the only orbital in energy level 1. At energy level 2, there are both s and p orbitals, with the 2s having lower energy than the 2p. The three 2p subshells are represented by three dashes of the same energy. The figure also shows energy levels 3, 4, and 5. Note that the 4s orbital has lower energy than the 3d.

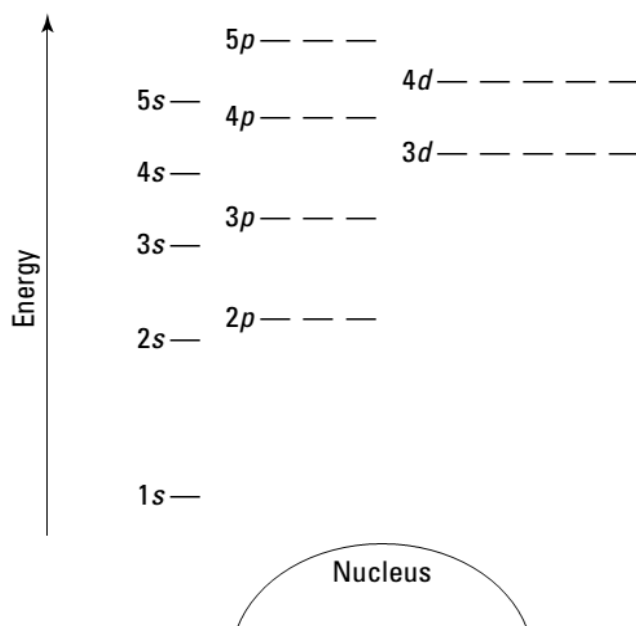

Figure 2.13: Blank energy level diagram of oxygen

In using the energy level diagram, two things should be observed:

- Electrons fill the lowest vacant energy levels first.
- When there's more than one subshell at a particular energy level, such as at the 3p or 4d levels, only one electron fills each subshell until each subshell has one electron. Then electrons start pairing up in each subshell. This rule is named Hund's rule.

Since the atomic number of oxygen is 8, that means that oxygen has eight protons in its nucleus and eight electrons. So we can put eight electrons into the energy level diagram. Electrons can be represented as arrows. Note that if two electrons end up in the same orbital, one arrow faces up and the other faces down. This is called spin pairing. It corresponds to the $+\frac{1}{2}$ and $-\frac{1}{2}$ of m_s . The first electron goes into the 1s orbital, filling the lowest energy level first, and the second one spin-

pairs with the first one. Electrons 3 and 4 spin-pair in the next-lowest vacant orbital - the 2s. Electron 5 goes into one of the 2p subshells and electrons 6 and 7 go into the other two totally vacant 2p orbitals. The last electron spin-pairs with one of the electrons in the 2p subshells (Fig. 2.14).

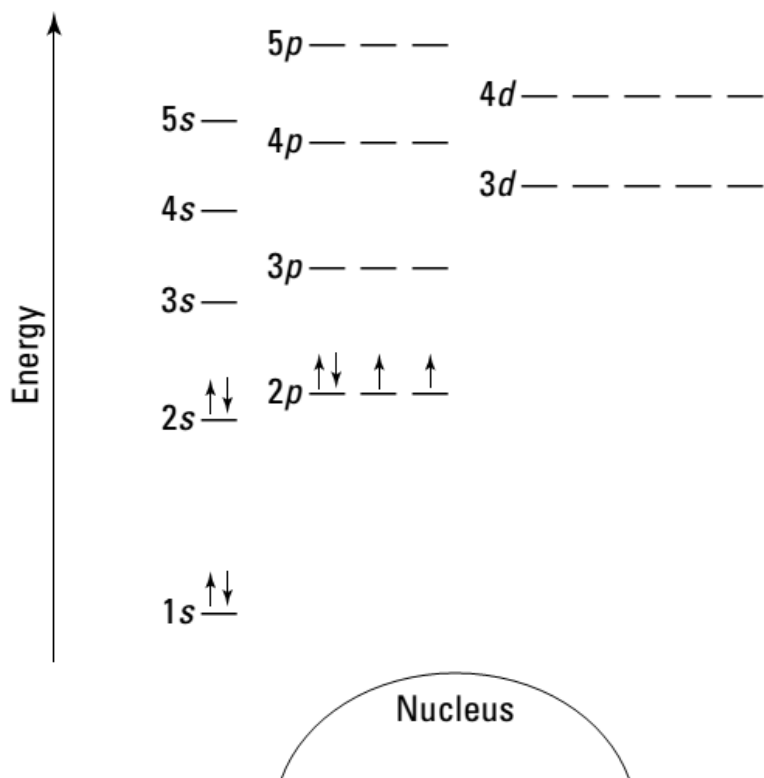

Figure 2.14: Completed energy level diagram of oxygen

Electron Configurations

The Aufbau principle is used to determine the electron configuration of an atom, molecule or ion. The principle postulates a hypothetical process in which an atom is "built up" by progressively adding electrons. As they are added, they

assume their most stable conditions (electron orbitals) with respect to the nucleus and those electrons already there.

According to the principle, electrons fill orbitals starting at the lowest available (possible) energy levels before filling higher levels (e.g. 1s before 2s). The number of electrons that can occupy each orbital is limited by the Pauli Exclusion Principle. If multiple orbitals of the same energy are available, Hund's rule states that unoccupied orbitals will be filled before occupied orbitals are reused (by electrons having different spins).

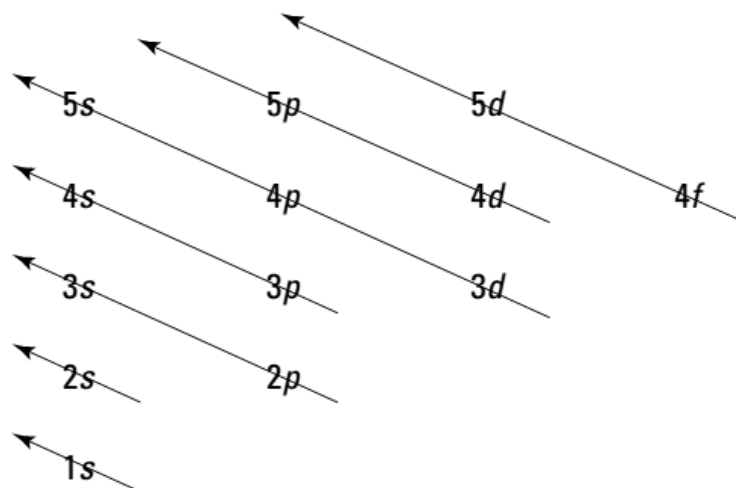

Figure 2.15: The Aufbau filling chart

The electron configuration for oxygen is $1s^2 2s^2 2p^4$. Compare that notation with the energy level diagram for oxygen in Fig. 2.13–2.14. The first two electrons in oxygen fill the 1s orbital, so you show it as $1s^2$ in the electron configuration. The 1 is the energy level, the s represents the type of orbital, and the superscript 2 represents the number of electrons in that orbital. The next two electrons are in the 2s orbital, so you write $2s^2$. And finally, you show the four electrons in the 2p orbital as $2p^4$. Put it all together, and you get $1s^2 2s^2 2p^4$. The sum of the superscript numbers equals the atomic number, or the number of electrons in the atom. Likewise, the electronic

configuration of chlorine (Cl) is $1s^2 2s^2 2p^6 3s^2 3p^5$ and iron (Fe) is $1s^2 2s^2 2p^6 3s^2 3p^6 4s^2 3d^6$.

Questions

1. Write the EC for the first 30 elements on the periodic table.
2. Using the arrow notation and recalling Hund's rule, write down the electronic configuration of Mg, Fe and Cobalt.

CHAPTER THREE

3.0 Chemical Bonding

This is the union of two or more atoms to form a stable compound. Valency is the combining power of an element. Chemical combination can take any of the following forms:

- i. Ionic Bonding (Electrovalence)
- ii. Covalent Bonding
- iii. Co-ordinate bonding (Dative)
- iv. Metallic Bonding
- v. Hydrogen Bonding
- vi. Van der waal Forces

3.1 Electrovalency

This involves the transfer of electron from one atom to another; usually from metallic atom to non-metal. The atom that loses the electron becomes positively charge and the one that gain the electron becomes negatively charge. Consider the formation of NaCl from Na-metal and chlorine. Na with one electron in its outermost shell loses it to chlorine atom whose number of electron in the outermost shell now becomes 8; thus attaining the Octet State.

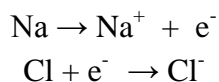

The formation of NaCl involves the following processes.

- i. Vapourization of Sodium

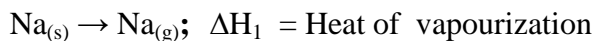

- ii. Ionization of Sodium

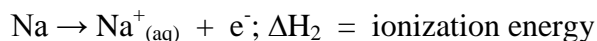

iii. Dissociation of chlorine

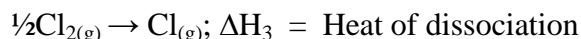

iv. Electron affinity of chlorine

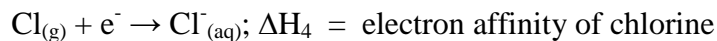

v. The $\text{Na}^+_{(\text{aq})}$ and $\text{Cl}^-_{(\text{aq})}$ are joined together by electrostatic attraction releasing lattice energy:

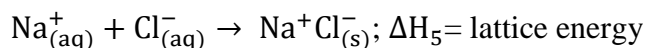

The formation of NaCl, ΔH_f is the algebraic sum of these different heats of reactions:

$$\Delta H_f = \Delta H_1 + \Delta H_2 + \Delta H_3 + \Delta H_4 + \Delta H_5$$

3.2 Covalency

This involves the sharing pair of electrons between the atoms involved. Only electrons in unpaired atomic orbitals may be contributed for sharing. Sharing involves the overlap of two atomic orbitals; each of which contains an unpaired electrons. Such an overlap results in the formation of molecular orbital from the two atomic orbital. Two conditions necessary for the overlap of atomic orbitals are:

- i. The overlapping atomic orbital must be of similar energy levels.
- ii. The orbital must be in the same plane.

The overlap of the S-orbital of two hydrogen atoms is shown in Fig. 3.1.

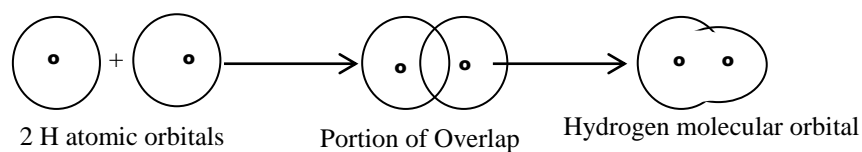
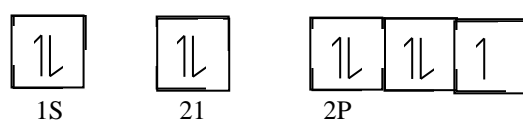

Figure 3.1: Formation of hydrogen molecular orbital

The EC of the resulting molecular orbital is $1s^2$. The driving force for the overlap is the attainment of a stable, noble gas electronic configuration.

For Fluorine with atomic number 9,



There is the p-orbital with an unpaired electron. The overlap of this orbital with a similar orbital in a second fluorine atom results in a molecular orbital of fluorine.

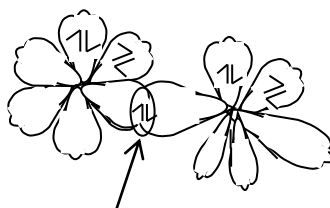

Overlapping p-orbitals of fluorine

Figure 3.2: Molecular orbital of fluorine

Hybridization

This is the equalization of energy of unpaired orbitals. Consider carbon with two unpaired electrons and EC of $1s^2 2s^2$

$2P_x^1 2P_y^1 2P_z^0$. But it shows a covalency of four rather than two suggested by this EC. To account for its tetravalence it is proposed that the ground state carbon first absorbs energy to become excited before bonding takes place. The energy absorbed is used to promote a 2s-electron into the vacant 2p-orbital. An excited carbon atom thus has the electronic configuration of $1s^2 2s^1 2P_x^1 2P_y^1 2P_z^1$.

Note that 2s-orbital is spherical and of lower energy than the 2p-orbitals and that the three 2p-orbitals are at right angles to one another.

The tetrahedral structure of CH_4 , CCl_4 , etc is accounted for by assuming that before the overlap of the orbitals of the excited carbon atom by four hydrogen or chlorine atoms to form CH_4 or CCl_4 , there is a rearrangement of the unpaired orbitals. This rearrangement involves an equalization in energy of the four unpaired orbitals and their spreading out.

In the case leading to the formation of CH_4 or CCl_4 , hybridization involves one s-orbital and three p-orbitals. It is thus called sp^3 (reads, sp-three) hybridization. After spreading out, the unpaired orbitals are aligned at $109^\circ 28'$ away from each other.

If only two of the three unpaired p-orbital in an excited carbon atom hybridize with the unpaired 2s orbital, sp^2 hybridization is said to have taken place. It results in three hybrid orbitals directed 120° away from each other on the same plane.

The linear overlap of an sp^2 hybridized orbital of one carbon atom with a similar orbital of a second carbon atom results in a strong bond called sigma (σ) bond. At the same time, the unhybridized p-orbitals of the two carbon atoms also overlap laterally but to a smaller extent. A weaker bond, called Pi (π) bond is formed. Thus there is a double bond between the two

carbon atoms; one of which is a σ -bond and the other Pi-bond. The final product is a molecule of ethene.

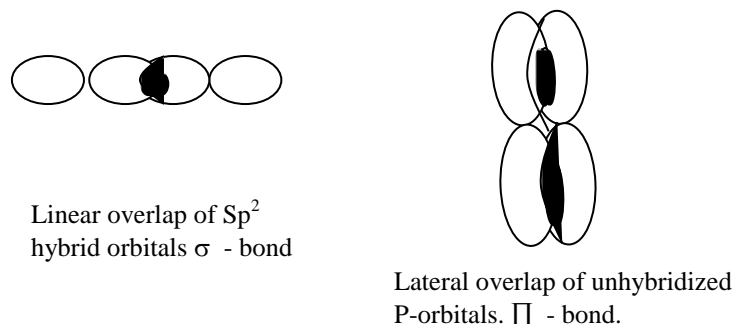

Figure 3.3: Formation of a double bond between two carbon atoms

A triple bond is formed when only one unpaired p-orbital and the $2s^1$ -orbital of an excited carbon atom hybridize. This hybridization is termed sp -hybridization. The two hybrid orbitals spread out fully, so that one is 180° away from the other.

The two unhybridized p-orbitals remain at right angles with the hybrid ones. When two carbon atoms involved in sp hybridization come close to one another their hybrid orbitals overlap effectively to form a σ -bond. At the same time, their two unhybridized p-orbitals also overlap. Thus there are three bonds between the two carbon atoms. One is σ -bond resulting from the effective overlap of hybrid orbitals. The other two are π -bonds, resulting from a less effective overlap of unhybridized orbitals. The final product is a molecule of ethyne.

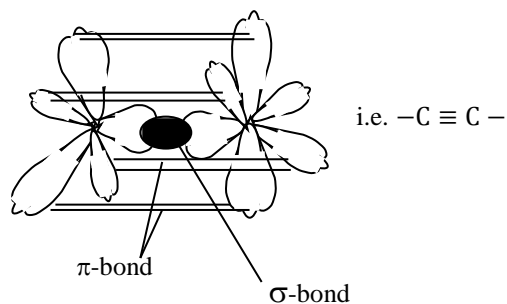

Figure 3.4: Formation of ethyne

3.3 Dative Bonding

This is similar to covalent bonding but the difference lies in the fact that the electron being shared is donated by one of the participating atom as illustrated in the formation of ammonium ion, NH_4^+ .

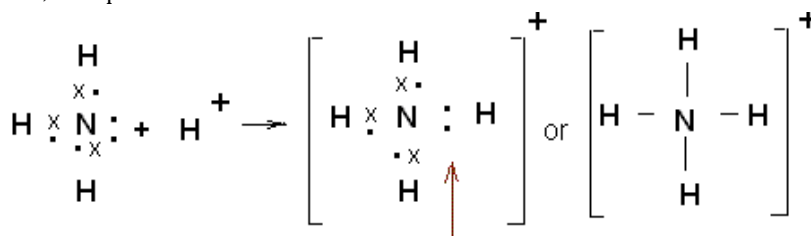

Figure 3.5: Formation of an ammonium ion

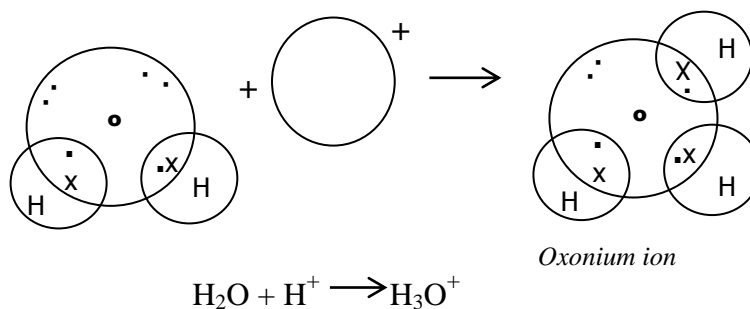
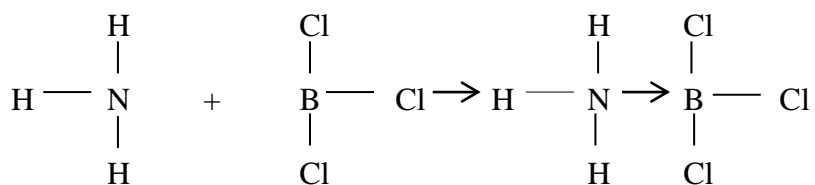

Figure 3.6: Formation of an oxonium ion



Compounds containing coordinate covalent bonds have similar properties with compounds containing purely covalent bonds. They are however less volatile.

3.4 Metallic Bonding

X-ray analysis shows that the atoms of most metals are held together in a lattice of closely packed spheres in three dimensions. In this state, the valence electrons are loosely held, therefore tend to be separated from their nuclei. We, thus have a metal crystal lattice containing positive metal ions surrounded by a cloud (or sea) of randomly moving electrons or delocalized electrons. The negatively charged sea of electrons acts like cement binding the positively charged nuclei together. This constitutes the **metallic bond**. The assumption is that each metal atom in the crystal contributes its valence electrons and that the “free” electrons help to “cement” the positive ions together.

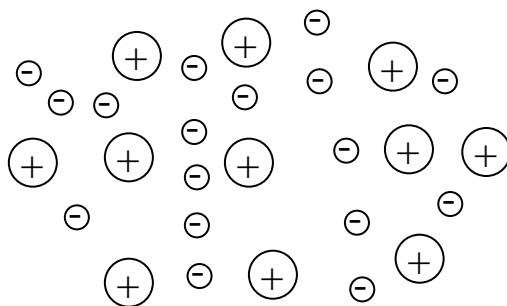

Figure 3.7: Diagram of metallic bonding sea of electron model

The sea of mobile electrons conduct heat and electricity. The metal cations can be moved around when the metal is hammered into sheet or drawn into a wire.

Metallic bond varies in strength from metal to metal. For example metallic bond is stronger in iron than in sodium or potassium.

The ability of metals to conduct heat and electricity is due to the presence of “free” electrons, which can move through the metal structure when it is connected to electricity.

Polar Molecules

Hydrogen fluoride is an example of a polar molecule. In hydrogen fluoride, the fluorine atom attracts electrons more strongly than the hydrogen atom, pulling the pair of bonding electrons more closely towards itself and thereby distorting the electron cloud, as shown in Fig. 3.8.

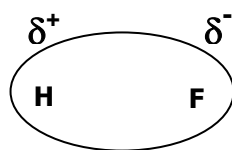
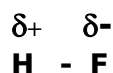

Figure 3.8: The uneven distribution of electron cloud in HF molecule

The electrons in the bond now have a greater probability of being nearer the fluorine atom than the hydrogen atom. The result of the uneven distribution of charge is that one end of the molecule becomes slightly positively charged while the other end slightly negatively charged. The molecule is said to be **polarised:**



Hydrogen fluoride is called a polar molecule because of its uneven charge distribution. It is still predominantly a covalent molecule and not an ionic compound. The symbol δ (delta) is used to indicate a fractional charge. There are many polar molecules. Some are shown in Fig. 3.9.

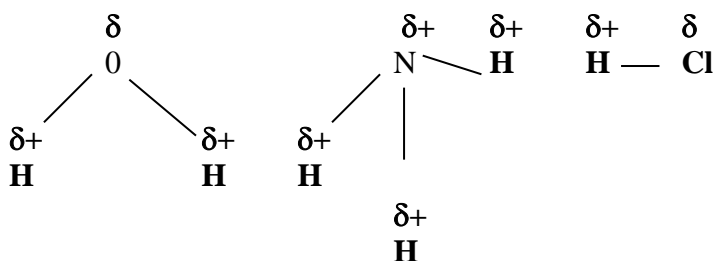

Figure 3.9: Example of polar molecules

The explanation for the development of partial positive and negative charges on the atoms of molecules is that the electrons in the bonds are not equally shared. The bond is called polar covalent bond. The separation of charges in a polar molecule makes it a dipole (i.e. two poles of charge in the molecule). The dipole moment of a molecule is a measure of the degree of polarisation of that molecule.

Polarity and Electronegativity

The concept of **electronegativity** helps us to determine whether a molecule is polar or not. Electronegativity values enable us to measure the degree to which the bond between two atoms is ionic or covalent. The electronegativity of an atom is a measure of its ability to attract electrons in a bond towards itself. The greater the electronegativity value, the greater the tendency. The scale of electronegativity runs from 0 to 4. Part of Pauling's electronegativity scale which is the most widely used is shown in Table 3.1.

Table 3.1: Electronegativity values for some elements

H 2.1						
Li 1.0	Be 1.5	B 2.0	C 2.5	N 3.0	O 3.5	F 4.0
Na 0.9	Mg 1.2	Al 1.5	Si 1.8	P 2.1	S 2.5	Cl 3.0
K 0.8	Ca 1.0	Ga 1.6	Ge 1.8	As 2.0	Se 2.4	Br 2.8
Rb 0.8	Sr 1.0	In 1.5	Sn 1.8	Sb 1.9	Te 2.1	I 2.5

The difference between values is related to the degree of ionic character in a bond. If the difference exceeds 1.7, then the ionic character exceeds 50%.

3.5 Hydrogen Bonding

Earlier we saw that many molecules are polar, especially, molecules in which a highly electronegative atom is joined to a hydrogen atom. Examples are hydrogen fluoride, water and ammonia (see Fig. 3.9).

If two molecules of hydrogen fluoride are placed close to each other, there will be attraction between the slight positive charge of hydrogen of one molecule and the slight negative charge of fluorine of the other molecule. This attraction is an example of a hydrogen bond.

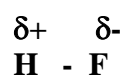

The hydrogen atom is smaller than the other atoms, and its nucleus is only slightly screened, hence, it is able to attract the negative end of the other molecule strongly. The strength of the hydrogen bond is determined by the lone pair of electrons on the electronegative element.

Though hydrogen bond is only a weak bond, when compared with the other conventional bonds, yet it has significant effects on the physical properties of molecules. For example, the melting and boiling points of ammonia, water and hydrogen fluoride are abnormally high in comparison with those of their corresponding hydrides. Hydrogen bond is an example of a strong dipole-dipole attraction.

Table 3.2: Boiling points of some hydrides of groups V, VI and VII

Molecule with Hydrogen bond	Boiling Point (°C)	Corresponding Hydride	Boiling Point (°C)
H ₂ O	100	H ₂ S	-62
HF	20	HCl	-85
NH ₃	-35	PH ₃	-87

Hundreds of hydrogen bonds may be formed along the length of two adjacent protein molecules, producing a large cumulative effect. Cellulose molecules are also held together by hydrogen bonds to form fibres.

When hydrogen bonds occur between two different molecules, they are known as intermolecular hydrogen bonds, but if they occur within the same molecule, they are known as intramolecular hydrogen bonds.

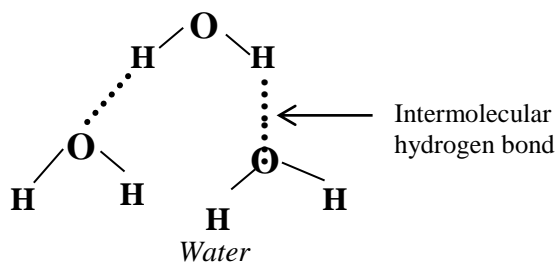
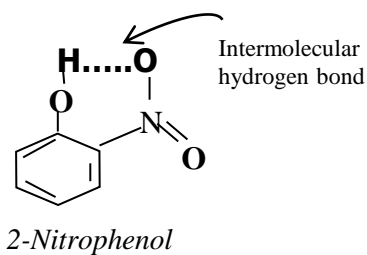
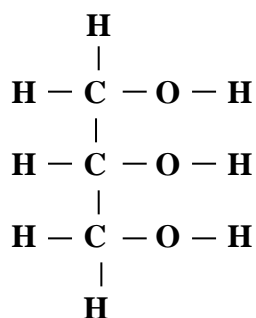

Figure 3.10: Intermolecular hydrogen bonding in 2-nitrophenol and water

An important property of liquids with intermolecular forces like hydrogen bonding is viscosity, a measure of a liquid's resistance to flow. For example, propane-1,2,3-triol (glycerol) whose structure is given below:



Glycerol is very viscous, mainly because of its high ability to form hydrogen bonds.

3.6 Van der Waal Forces

Weak forces of attraction do exist between discrete non-polar molecules. These forces make it possible to liquefy non-polar substances even at lower temperatures. These intermolecular attractions are one reason real gases deviate from, the ideal gas laws. The forces hold helium atoms or covalent molecules like iodine together in a liquid or solid state. The forces are known as Van der Waals' forces or bonds.

The electrons in an atom are not fixed in space, over very short periods of time (i.e. at a particular instant which may be millionths of a second), the charge is not completely evenly distributed. There is an instantaneous asymmetry in the electron distribution around the nucleus. There will result an instantaneous polarization dipole on the atom or molecule. That is to say there will be a separation of positive and negative charge. This dipole is only a temporary one unlike the one in say hydrogen chloride, which is permanent.

Now any other atom that is next to an atom with an instantaneous dipole will experience an induced dipole (i.e. its atom will experience an induced separation of charge). These two dipoles will momentarily attract each other. We thus, have an instantaneous dipole-induced dipole attraction between neighbouring atoms or molecules as the case may be.

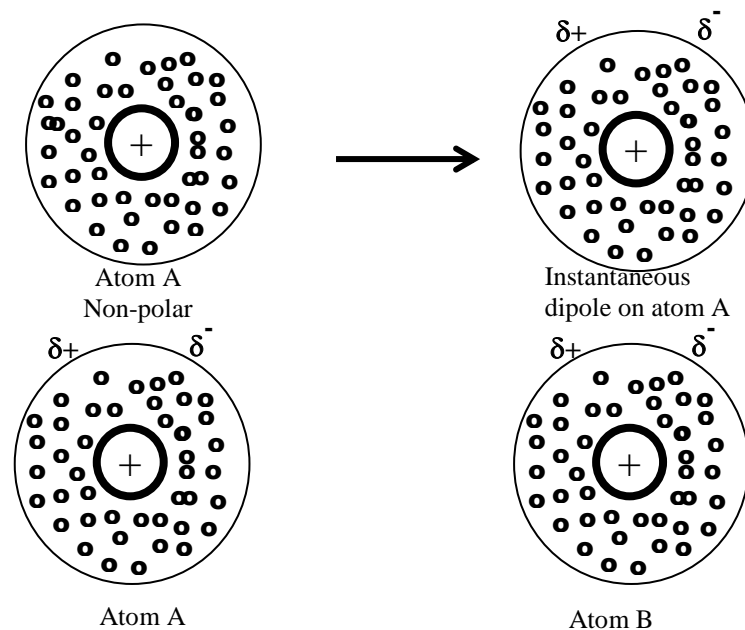

Instantaneous dipole on atom A induces a dipole on atom B

Figure 3.11: An instantaneous polarization in an atom A creating an instantaneous dipole, creating an induced dipole on a neighbouring atom B

We have already known that the outer electrons in a large atom are less strongly attracted by the nucleus, unlike in small atoms where the outer electrons are more firmly held by the nucleus. This means that the electron cloud of a large atom will be more easily distorted than that of a small atom. Another way of describing this is to say that large atoms are more easily polarizable than small atoms. The same thing can be said of molecules, that as the molecules become larger, they will become more polarizable, since large molecules are made up of large atoms and consequently large electron cloud resulting in larger instantaneous dipoles. Therefore, Van der Waals' forces

between molecules (or atoms) increase with their relative molecular mass (or atomic mass). This is noticed in the increase in the boiling points of a homologous series, with increasing relative molecular mass (Table 3.3).

Van der Waals forces, as weak forces, have between one-tenth and one-hundredth the strength of a normal covalent bond. They are however strong enough to hold together the layers present in iodine and graphite crystals.

Table 3.3: Boiling points of the alkanes

Molecule	Formula	Boiling Point (°C)
Methane	CH ₄	-161
Ethane	C ₂ H ₆	-88
Propane	C ₃ H ₈	-44
Butane	C ₄ H ₁₀	0
Pentane	C ₅ H ₁₂	36
Hexane	C ₆ H ₁₄	69

CHAPTER FOUR

4.0 Gases

In Chapter One, we have discussed matter and its different states. This chapter focuses on gases and their various laws. Despite the randomness of gases, the study of gaseous state is very simple. This is because all gases regardless of their nature behave identically under the same experimental conditions, and this generality in behaviour is usually stated in the form of certain laws collectively called the gas laws (See Fig. 4.1)

4.1 Ideal and Real Gases

Ideal Gases

Ideal gas, or perfect gas, is the theoretical substance that helps establish the relationship of four gas variables, pressure (P), volume (V), the amount of gas (n) and temperature (T). It has characters described as follow:

- The particles in the gas are extremely small, so the gas does not occupy any spaces.
- The ideal gas has constant, random and straight-line motion.
- No forces between the particles of the gas. Particles only collide elastically with each other and with the walls of container.

Real Gases

Real gas, in contrast, has real volume and the collision of the particles is not elastic, because there are attractive forces between particles. As a result, the volume of real gas is much larger than of the ideal gas, and the pressure of real gas is lower than of ideal gas. All real gases tend to perform ideal gas behaviour at low pressure and relatively high temperature.

The compressibility factor (Z) tells us how much the real gases differ from ideal gas behaviour.

$$Z = PV/nRT$$

For ideal gases, $Z=1$, for real gases, $Z \neq 1$.

4.2 Gas Laws

Created in the early 17th century, the gas laws have been around to assist scientists in finding volumes, amount, pressures and temperature when coming to matters of gas. The gas laws consist of three primary laws: Charles' Law, Boyle's Law and Avogadro's Law. Others are Dalton's Law of Partial Pressures, Graham's Law of Diffusion and Gay-Lussac Law. These laws combine into the General Gas Equation and Ideal Gas Law. The three fundamental gas laws discover the relationship of pressure, temperature, volume and amount of gas. Boyle's Law tells us that the volume of gas increases as the pressure decreases. Charles' Law tells us that the volume of gas increases as the temperature increases. And Avogadro's Law tell us that the volume of gas increases as the amount of gas increases. The ideal gas law is the combination of the three simple gas laws.

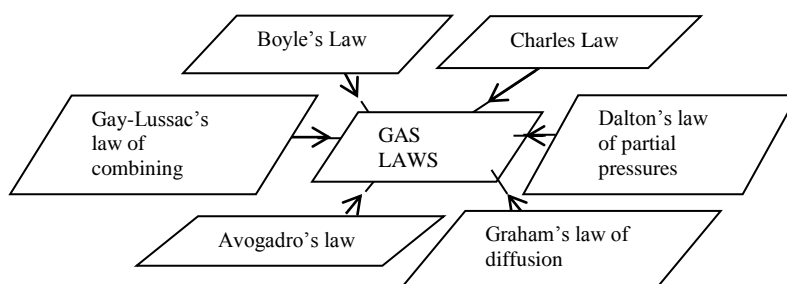

Figure 4.1: Gas Laws

These laws can easily be remembered by (the mnemonics) ABCDGgl. where A stands for Avogadro's law, B stands for Boyle's law, C stands for Charles' law, D stands for Dalton's law of partial Pressures, G stand for Graham's law of Diffusion and gl stands for Gay-Lussac's law of combining volumes.

The relationship between some of these gas laws is also summarized in Fig 4.2 followed by the detailed discussion of each gas law.

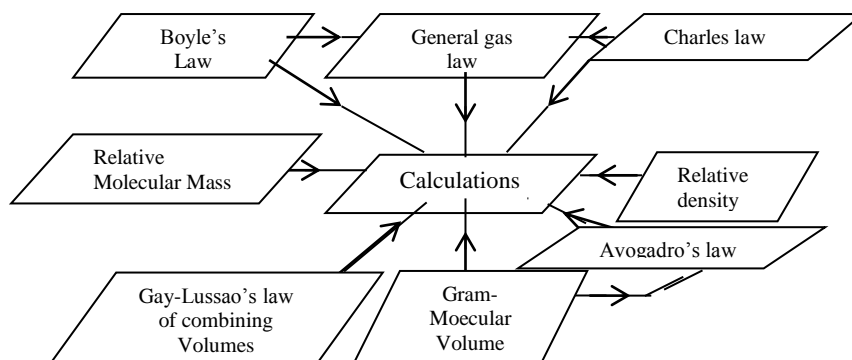

Figure 4.2: Relationship between some gas laws

4.3 Boyle's Law (1662)

This law relates the pressure of a fixed mass of a gas to its volume at constant temperature. It is concerned with the compressibility of gases and this is a characteristic property of all gases.

The law states that

at constant temperature, the volume of a fixed mass of gas is inversely proportional to the pressure acting on it.

Mathematically, it is expressed as

$$\text{Volume, } V \propto \frac{1}{\text{Pressure, } P}$$

at constant temperature (T)

Generally, for a fixed mass of gas at constant temperature, the product of its volume and pressure is always a constant, i.e. $P_1V_1 = P_2V_2 = P_nV_n = \text{constant}$, if temperature is kept constant.

The diagrams below illustrate the law.



Figures 4.3: Illustrations of Boyle's Law

The above diagrams show that pressure is always doubled when volume is halved. The graphical illustration is shown below:

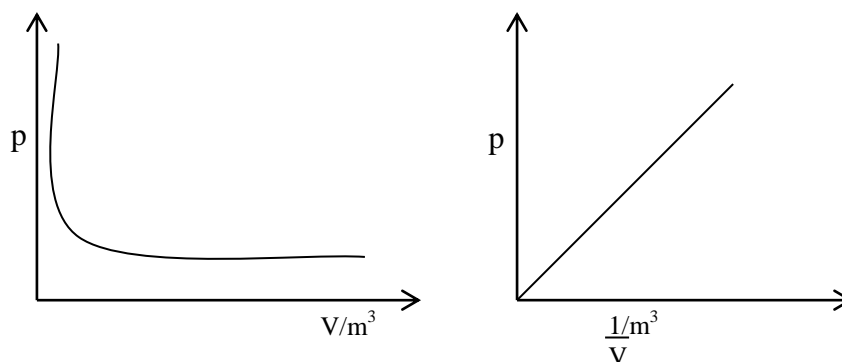

Figure 4.4: Graphical illustrations of Boyle's Law

$$V = \frac{K}{P}$$

where, K = constant of proportionality

Thus,

$$K = PV$$

Or

$PV = \text{constant}$ at constant temperature.

4.4 Charles' Law (1787)

Charles' law deals with relation between volume and temperature of a fixed mass of a gas at constant pressure. That is, it concerns thermal expansion, which is another characteristic property of gases.

Charles' law states that at constant pressure, the volume of a fixed mass of gas increases by part of its volume at 0 °C: i.e. that the volume of a fixed mass of a gas at constant pressure varies linearly with the absolute temperature.

Suppose the volume of a fixed mass of a gas at a specified pressure and 0 °C be V_0 . Then, according to Charles' law, its volume at

1 °C will be

$$V_0 + \left(\frac{1}{273}\right) V_0 \dots\dots\dots(1)$$

2 °C will be

$$V_0 + 2\left(\frac{1}{273}\right) V_0 \dots\dots\dots(2)$$

t °C will be

$$V_0 + t\left(\frac{1}{273}\right) V_0 = V_0\left(1 + \frac{t}{273}\right) = \frac{(273+t)}{(273)} V_0 \dots\dots(3)$$

Now considering the volume of the above gas at t_1 °C to be V_1 and at t_2 °C to be V_2 , then according to Charles' Law.

$$V_1 = V_0 + \left(\frac{t_1}{273}\right) V_0 = V_0\left(1 + \frac{t_1}{273}\right) = \left(\frac{273+t_1}{273}\right) V_0 \dots\dots\dots(4)$$

$$\text{and } V_2 = V_0 \div \left(\frac{t_2}{273}\right) = V_0 \left(1 + \frac{t_2}{273}\right) = \left(\frac{273+t_2}{273}\right) V_0 \dots\dots\dots(5)$$

Dividing Equation (4) by Equation (5), we get

$$\frac{V_1}{V_2} = \frac{V_0}{273} (273+t_1) / \frac{V_0}{273} (273+t_2) = \frac{273+t_1}{273+t_2} \dots\dots\dots(6)$$

And if we define a new scale of temperature where the dimensions of a degree remain unchanged but the 0 °C shifted to -273 °C. The °C can be converted into this new scale by adding 273 to it i.e. t °C = t + 273 = °T on new scale. This new scale of temperature is known as Absolute scale of temperature, abbreviated as °A or °K (for Absolute or Kelvin, respectively).

$$t \text{ } ^\circ\text{C} = (t + 273) \text{ } ^\circ\text{A} = T \text{ } ^\circ\text{A}$$

$$t_1 \text{ } ^\circ\text{C} = (t_1 + 273) \text{ } ^\circ\text{A} = T_1 \text{ } ^\circ\text{A}$$

$$t_2 \text{ } ^\circ\text{C} = (t_2 + 273) \text{ } ^\circ\text{A} = T_2 \text{ } ^\circ\text{A} \quad \text{and so on}$$

Considering Equation (6) and substituting for the known, we have

$$\frac{V_1}{V_2} = \frac{t_1 + 273}{t_2 + 273} = \frac{T_1}{T_2} \dots\dots\dots(7)$$

$$\text{or } \frac{V_1}{T_1} = \frac{V_2}{T_2} \dots\dots\dots(8)$$

Similarly we can show that

$$\text{or } \frac{V_1}{T_1} = \frac{V_2}{T_2} = \frac{V_3}{T_3} = \text{etc} = \text{constant} \dots\dots\dots(9)$$

at constant pressure,

In general,

$$\frac{V}{T} = \text{constant, at constant pressure,}$$

That is,

$$V = \text{constant} \times T$$

or $V \propto T$ which is an important consequence of Charles' law. In other words, at constant pressure the volume of a fixed mass of a gas is directly proportional to the absolute temperature.

Application of Charles' Law

If we know the volume of a fixed mass of a gas at one temperature its volume at another temperature can be calculated provided the pressure is kept constant.

Example 1

The volume of a fixed mass of CO_2 at 1 atm pressure and 27°C is 2 litres. Calculate its volume at 57°C and 1 atm pressure

Solution

According to Charles' Law

$$V \propto T \text{ or } \frac{V_1}{T_1} = \frac{V_2}{T_2} \text{ at constant pressure}$$

where, V_1 and T_1 are initial volume and temperature, respectively, and V_2 and T_2 are final volume and temperature respectively.

$$T = t^\circ\text{C} + 273$$

Since $V_1 = 2$ litres

$$T_1 = 27 + 273 = 300 \text{ K}$$

$$V_2 = ?$$

$$T_2 = 57 + 273 = 330 \text{ K}$$

Then,

$$V_2 = \frac{V_1}{T_1} \times T_2 = \frac{2 \text{ litres} \times 330^\circ \text{ A}}{300^\circ \text{ A}} = 2.2 \text{ litres}$$

Deviation from Charles' Law

For any real gas at high pressures and at temperatures near liquefaction point, deviations from Charles' Law are observed. Near the liquefaction point the observed volume is less than that predicted by Charles' law. This is explained by the intermolecular forces of attraction coming into play which consequently bringing the molecules closer together and thus decreasing their gaseous volume.

Note that in both Boyle's and Charles' laws, the mass of a gas under consideration must be fixed and one of the variables must be kept constant.

4.5 Dalton's Law of Partial Pressures

The Dalton's law of partial pressures is concerned with the pressure of a mixture of gases. It states that at constant temperature the total pressure of a mixture of gases in a fixed volume is equal to the sum of the partial pressures of the individual gases.

By partial pressure of a gas in a mixture of different gases it is meant the pressure each of the gases would exert if the volume of the mixture were entirely occupied by that particular gas alone under consideration and the mass of the gas must be equal to the same mass of that gas in the mixture.

For example, let there be three gases X, Y and Z in a mixture of gases whose total pressure is P, If P_x , P_y and P_z are the corresponding partial pressure, of the gases, then according to Dalton's law of partial pressures,

$$P = P_x + P_y + P_z \dots\dots\dots(10)$$

This law is important in the calculation of pressure of a gas collected over water at known temperature since the collected gas will be a mixture of the gas and vapour.

Example 2

If 40.0 litres of nitrogen is collected over water at 22 °C when the atmospheric pressure is 0.956 atm., what is the volume of

the dry nitrogen gas at standard temperature and pressure, assuming ideal behaviour (water vapour pressure at 22 °C = 0.026 atm.)

Solution

	Initial condition		Final condition
Volume	40.0		? (Litres)
Pressure	0.956-0.026 0.930	=	1.00 (atm)
Temperature	22°C = 295		273 (K)

Since there is an increase in pressure there will be a decrease in volume.

Pressure changes to $\frac{1.00}{0.930}$ of its original values

Hence,

The change in volume will be $\frac{0.930}{1.00}$ of its original value

Temperature changes to $\frac{273}{295}$ of its original value and

therefore,

Volume changes to $\frac{273}{295}$ of its original volume since volume varies linearly with temperature at constant pressure (Charles' law).

Therefore,

$$V_f = V_i \left(\begin{array}{c} \text{correction for pressure} \\ \text{change} \\ \times \\ \text{correction for temperature} \\ \text{change} \end{array} \right)$$

where, V_i = initial volume = 40.0 litres and V_f = final volume

$$V_f = 40.0 \text{ litres} \times \left(\frac{0.930}{1.000} \right) \times \frac{273}{295} = 34.4 \text{ litres}$$

4.6 Graham's Law of Diffusion

This law quantitatively relates the speed of diffusion of a gas to its density. It states that the rate of diffusion of a gas is inversely proportional to the square root of its density.

Mathematically, it is stated as

$$r \propto \frac{1}{\sqrt{D}} \quad \dots \dots \dots (11)$$

Or

$$\frac{1}{r} \propto \sqrt{D} \quad \dots \dots \dots (12)$$

where, r = rate of diffusion, D = vapour density

By diffusion we generally mean the tendency of all gases to mix spontaneous and in the present discussion it is referred to the leaking of gases through fine pores or porous diaphragms.

By rate of diffusion, r , we mean the volume of the gas diffused in unit time (in one second or one minute) under specified conditions of temperature and pressure and is expressed as m/sec^{-1} or M/minute^{-1} .

The density (D) may be either the mass per litre or the vapour density. According to Graham's law of diffusion,

$$r = \frac{\text{constant}}{\sqrt{D}} \quad \dots \dots \dots (13)$$

If we now consider two gases whose vapour densities are D_1 and D_2 under a specified condition of temperature and pressure, let their rates of diffusion be r_1 and r_2 respectively.

Then,

$$r_1 \propto \frac{1}{\sqrt{D_1}} \text{ or } r_1 = \frac{\text{constant}}{\sqrt{D_1}} \dots \dots \dots (14)$$

and

$$r_2 \propto \frac{1}{\sqrt{D_2}} \text{ or } r_2 = \frac{\text{constant}}{\sqrt{D_2}} \dots \dots \dots (15)$$

Dividing Equation (14) by Equation (15), we have

$$\frac{r_1}{r_2} = \frac{\sqrt{D_2}}{\sqrt{D_1}} \dots \dots \dots (16)$$

Squaring both sides of Equation (16), we have

$$\left(\frac{r_1}{r_2}\right)^2 = \frac{D_2}{D_1} \dots \dots \dots (17)$$

and

$$\left(\frac{r_1}{r_2}\right)^2 = \frac{2 \times D_2}{2 \times D_1} = \frac{M_2}{M_1}$$

where, M_1 , M_2 are molecular masses of the two gases under consideration.

The relationship between the vapour density and relative molecular mass of a gas is derived from two laws, namely Gay – Lussac’s and Avogadro’s laws, discussed in sections 4.7 and 4.8.

4.7 Gay-Lussac's Law and Relative Density of Combining Volumes (1808)

This law states that the volumes of gases taking part in a chemical reaction, either as reactants or products, bear a simple numerical relation to one another, provided that all measurements are made under the same conditions of temperature and pressure.

The relative density of a gas is defined as the mass of a given volume of the gas compared with the mass of an equal volume of hydrogen measured under the same conditions of temperature and pressure.

Mathematically,

$$\text{Relative Density} = \frac{\text{Mass of volume of Gas}}{\text{Mass of Volume of Hydrogen}} \dots (18)$$

But from Avogadro's law, both volumes contain equal number of molecules.

Therefore,

$$\text{Relative Density} = \frac{\text{Mass of } n \text{ molecules of Gas}}{\text{Mass of } n \text{ molecules of Hydrogen}} \dots (19)$$

Or

$$\text{Relative Density} = \frac{\text{Mass of 1 molecules of Gas}}{\text{Mass of 1 molecules of Hydrogen}} \dots (20)$$

Since the relative molecular mass of H_2 is approximately 2, and substituting into Equation (20) we have

$$\text{Relative Density} = \frac{\text{Relative molecular mass of Gas}}{2}$$

Or

$$\text{Relative Molecular Mass} = 2 \times \text{Relative Density} \dots (21)$$

Or

$$M = 2 \times D$$

Sometimes, the relative density is referred to as vapour density (V.D).

Application of Graham's Law of Diffusion

The important application of the law is to determine the molecular mass of a gas by measuring its rate of diffusion. Once the rates (r_1 and r_2) of two gases are determined and if the molecular mass of any of the gases is known the molecular mass of the other gas can be calculated, from the expression relating their rates with their vapour densities or relative molecular masses:

$$\frac{r_1}{r_2} = \frac{\sqrt{D_2}}{\sqrt{D_1}}$$

$$\left(\frac{r_1}{r_2}\right)^2 = \frac{D_2}{D_1} = \frac{2 \times D_2}{2 \times D_1} = \frac{M_2}{M_1}$$

Example 3

50 ml of hydrogen and oxygen diffuse in 10 and 40 seconds respectively through a fine porous plug. Assuming that the molecular mass of hydrogen is 2, calculate the molecular mass of O_2 .

Solution

First calculate the rates of diffusion of the gases and then relate these values to their molecular masses by the appropriate expression.

Let r_{H_2} and r_{O_2} be the respective rates of diffusion of hydrogen and oxygen.

Hence,

$$r_{H_2} = \frac{50\text{ml}}{10\text{sec}} = 5\text{ mls}^{-1}$$

and

$$r_{O_2} = \frac{50\text{ml}}{40\text{sec}} = \frac{5}{4}\text{ mls}^{-1} = 1.25\text{ mls}^{-1}$$

We know that,

$$\frac{r_1^2}{r_2^2} = \frac{M_2}{M_1}$$

That is,

$$\frac{(\text{Rate of diffusion of } H_2)^2}{(\text{Rate of diffusion of } O_2)^2} = \frac{\text{Molecular Mass of } O_2}{\text{Molecular Mass of } H_2}$$

That is,

$$\frac{5^2}{\left(\frac{5}{4}\right)^2} = \frac{\text{Mol. mass of } O_2}{5^2}$$

Molecular Mass of O_2 =

Therefore, the molecular mass of O_2 is 32.

Example 4

The rates of diffusion of carbon monoxide (CO) and ozone (O_3) were found to be 0.29 and 0.27 respectively. The relative density of CO is 22. What is the relative density of O_3 ?

Solution:

Let d_2 be the relative density of O_3 , then

$$\frac{\text{rate of diffusion of CO}}{\text{rate of diffusion of } O_3} = \frac{\sqrt{D_{O_3}}}{\sqrt{D_{CO}}}$$

where, D_{O_3} = relative density of O_3 and D_{CO} = relative density of CO

Substituting for the knowns,

$$\frac{0.29}{0.27} = \frac{\sqrt{d_2}}{\sqrt{22}}$$
$$\sqrt{d_2} = \sqrt{22} \times \frac{0.29}{0.27}$$

Squaring both sides, we get

$$d_2 = 22 \times \frac{(0.29)^2}{(0.27)^2} = 25.2$$

Therefore, the relative density of ozone is 25.2.

Example 5

100 ml of hydrogen take 20 min to diffuse out of a vessel. How long will 30 ml of oxygen take to diffuse under the same condition?

Solution

The relative density of hydrogen is 1 and that of oxygen is 16.

Let t be the time taken by O_2 to diffuse.

$$\text{Velocity of diffusion of } H_2 = \frac{100 \text{ ml}}{20 \text{ min}} = 5 \text{ mlmin}^{-1}$$

$$\text{Velocity of diffusion of O}_2 = \frac{30 \text{ ml}}{t \text{ (min)}} = \frac{30 \text{ mlmin}^{-1}}{t}$$

Applying Graham's law of equation

$$\frac{\text{Velocity of diffusion of H}_2}{\text{Velocity of diffusion of O}_2} = \frac{\sqrt{\text{density of O}_2}}{\sqrt{\text{density of H}_2}}$$

Substituting for the known values to obtain the unknown we get

$$\frac{5 \text{ mlmin}^{-1}}{\frac{30 \text{ mlmin}^{-1}}{t}} = \frac{\sqrt{16}}{\sqrt{1}} = \frac{4}{1}$$

$$\frac{5t}{30} = 4$$

$$5t = 30 \times 4 = 120$$

$$t = \frac{120}{5} = 24$$

Therefore, the time taken by O₂ to diffuse will be 24 min.

Example 6

Equal volumes of O₂ and CO₂ diffuse through a graphite plate in 896 seconds and 1065 seconds respectively. If the density of O₂ is 1.429 gms per litre, find the density of CO₂.

Solution

Let the volume of each of the gases be V.

$$\text{Rate of diffusion of } = \frac{V}{896}$$

and rate of CO₂ diffusion = $\frac{V}{1065}$

Density of O₂, d₁ = 1.429 g litre⁻¹

and the density of CO₂ be d₂,

$$\frac{r_{O_2}}{r_{CO_2}} = \frac{\sqrt{d_2}}{\sqrt{d_1}}$$

That is,

$$\frac{\frac{V}{896}}{\frac{V}{1065}} = \frac{\sqrt{d_2}}{\sqrt{1.429}}$$

$$\frac{1065}{896} = \sqrt{\frac{d_2}{1.429}}$$

$$\sqrt{d_2} = \sqrt{1.429} \times \frac{1065}{896}$$

Squaring both sides of the last expression, we get

$$d_2 = 1.429 \times \left(\frac{1065}{896}\right)^2 = 2.019$$

Therefore, the density of CO₂ is 2.019 g litre⁻¹

Example 7

127 ml of a certain gas diffuse in the same time as 100 ml of chlorine under the same conditions. Calculate the molecular mass of the gas.

Solution

Volume of gas, V₁ = 127 ml

Volume of Chlorine, $V_2 = 100$ ml
Molecular mass of chlorine, $M_2 = 71$

Let the molecular mass of the gas be M , and let time of diffusion of each gas be t .

Using

$$\frac{r_1}{r_2} = \frac{\sqrt{M_2}}{\sqrt{M_1}}$$

$$\frac{\frac{V_1}{t}}{\frac{V_2}{t}} = \frac{\sqrt{M_2}}{\sqrt{M_1}}$$

$$\frac{V_1}{V_2} = \frac{\sqrt{M_2}}{\sqrt{M_1}}$$

Or

$$\left(\frac{V_1}{V_2}\right)^2 = \frac{M_2}{M_1}$$

Substituting the known values, we have

$$\left(\frac{127}{100}\right)^2 = \frac{71}{M_1}$$

$$M_1 = 71 \times \frac{100^2}{127^2} = 44.02$$

Therefore, the molecular mass of the gas is 44.02.

Example 8

If 16 ml of hydrogen were to diffuse in 30 s, what volume of sulphur dioxide, SO₂, would diffuse in the same time under the same conditions of experiment?

Solution

$$\text{Density of } H_2 (d_1) = \frac{\text{mol.mass}}{2} = \frac{2}{2} = 1$$

$$\text{Density of } SO_2 (d_2) = \frac{\text{mol.mass}}{2} = \frac{64}{2} = 32$$

(since 2 x D = M).

Volume of H₂ that diffused in 30 s = 16 ml

Let the volume of SO₂ that diffused in 30 s be V₂ ml

Then,

$$\frac{\frac{V_1}{30}}{\frac{V_2}{30}} = \frac{\sqrt{d_2}}{\sqrt{d_1}}$$

$$\frac{V_1}{V_2} = \sqrt{\frac{d_2}{d_1}}$$

$$V_2 = \frac{V_1}{\sqrt{\frac{d_2}{d_1}}} = V_1 \sqrt{\frac{d_1}{d_2}}$$

$$i V_2 = V_1 \times \sqrt{\frac{d_1}{d_2}} = 16 \times \sqrt{\frac{1}{32}} = 2.83$$

Therefore, the volume of SO_2 that would diffuse in 30 seconds would be 2.83 ml.

4.8 Avogadro's Law (1811)

Avogadro's law summarizes two important facts about any gas: its volume at standard temperature and pressure (STP) and the number of molecules it contains under these conditions.

The law states that

“equal volumes of all gases under the same conditions of temperature and pressure contain the same number of molecules.”

At STP the value of this number of molecules is a constant for all gases and is known as Avogadro's number or constant (in honour of Amades Avogadro, 1776–1856) and has been numerically determined to be 6.023×10^{23} .

From this law we can deduce the definitions of the following terms:

Mole

One mole of a substance is defined as the amount of the substance which contains Avogadro's number (6.023×10^{23}) of particles (atoms, molecules or ions). In other words, the amount of substance which contains Avogadro's number of particles is called one mole. Thus, one mole of copper metal contains 6.023×10^{23} atoms; one mole of chlorine gas (Cl_2) contains 6.023×10^{23} molecules or since each molecule contains two atoms, $2 \times 6.023 \times 10^{23}$ atoms of chlorine.

One mole of sodium chloride (Na^+Cl^-) contains 6.023×10^{23} sodium ions (Na^+) and 6.023×10^{23} chlorine ions (Cl^-).

Molar Volume or Gram Molecular–Volume

Any volume occupied by one mole of a gas is called a molar volume or gram molecular volume. The volume occupied by one mole of any gas at STP is approximately 22400mls or 22.4 litres. In other words, a molar volume at STP (22.4 litres) contain Avogadro's number (6.023×10^{23}) of chemical species.

Gram-Atom

One gram-atom of any element is the relative atomic mass of that element expressed in grams. For example, the relative atomic mass of the element, copper (Cu) is 63.5 and that of sulphur (S) is 32.1. Therefore, one gram-atom of Cu would be 63.5 g and that of S would be 32.1 g.

One gram-atom of any element contains the same number of atoms; and generally for standard conditions of temperature and pressure (STP) this actual number of atoms is approximately 6.023×10^{23} .

Hence, since one gram-atom of any element and one mole of any substance at STP both contain the same Avogadro's number, it implies that one gram-atom is equivalent to one mole and vice versa. The importance of this relationship between gram-atom, mole or molar volume and Avogadro's number is seen in the calculation of relative atomic masses or relative molecular masses of elements or substances.

Example 9

0.56 g of a gas has a volume of 448 ml at STP. Calculate the relative molecular mass of the gas.

Solution

448 ml of gas at STP has a mass of 0.56 g

Thus,

1 ml of the gas at STP has a mass of $\frac{0.56}{448}$

Then,

22400 ml of the gas at STP will have a mass of $\frac{0.56}{448} \times 22400$ g

Therefore, the relative molecular mass of the gas is 28.

4.9 General Gas Equation

By general gas equation, it is meant an equation involving pressure, volume and temperature of a gas; and such an

equation is obtained by combining Charles' law with Boyle's law.

Considering a fixed mass of a gas whose pressure, volume and temperature are simultaneously changing. Let the pressure, volume and temperature before the change be P_1 , V_1 and T_1 and after the change be P_2 , V_2 and T_2 .

According to Boyle's law,

$$PV = \text{constant, at constant temperature}$$

and according to Charles' law,

$$\frac{V}{T} = \text{constant, at constant pressure}$$

For a simultaneous change of P , V and T , neither of the above Equations can be applied since neither pressure nor temperature is maintained constant in both cases.

But if the above change may be assumed to take place through an imaginary intermediate state, where the pressure is P_2 and volume V^1 and temperature T_1 , then the actual change,

$$\begin{array}{ccc} (P_1V_1T_1) & \longrightarrow & (P_2V_2T_2) \\ \text{Initial} & & \text{Final} \end{array}$$

Can be represented as

$$\begin{array}{ccccc} P_1V_1T_1 & \longrightarrow & P_2V^1T_1 & \longrightarrow & P_2V_2T_2 \\ \text{where} & & \text{imaginary} & & \text{Final} \\ & & \text{intermediate} & & \end{array}$$

during the first change temperature is kept constant and during the second change pressure is maintained constant. Hence, to the first change Boyle's law is applied while Charles' law may be conveniently applied to the second change. That is,

according to Boyle's law in the first change occurring at constant temperature, T_1

$$P_1V_1 = P_2V^1$$

Or

$$V^1 = \frac{P_1V_1}{P_2} \dots\dots\dots.22$$

and according to Charles' law in the second change at constant pressure, P_2

$$\frac{V^1}{T_1} = \frac{V_2}{T_2} \dots\dots\dots.23$$

Substituting for V^1 in equation (23), we get

$$\frac{P_1V_1}{T_1P_2} = \frac{V_2}{T_2}$$

Or

$$\frac{P_1V_1}{T_1} = \frac{V_2P_2}{T_2} \dots\dots\dots.24$$

Similarly, we can show that

$$\frac{P_1V_1}{T_1} = \frac{V_2P_2}{T_2} = \frac{V_nP_n}{T_n} = \text{constant} \dots\dots\dots.25$$

Or, in general,

$$\frac{PV}{T} = \text{constant} \dots\dots\dots.26$$

Or

$$PV = \text{Constant} \times T \quad \dots \dots \dots 27$$

This is the **general gas equation**. The value of the constant is determined by the nature of the gas and the mass of the gas. But if one gram-molecule (or one mole) of the gas is considered, the above constant turns to be a universal constant irrespective of the gas under consideration.

Thus, for one mole

$$PV = RT \quad \dots \dots \dots (28)$$

where, V = molar volume or gram-molecular, R = universal gas constant

If there are n moles of a gas under consideration, Equation (28) becomes

$$PV = nRT \quad \dots \dots \dots (29)$$

where, V = volume occupied by n moles of the gas

Evaluation of the Gas Constant, R

It is a well known fact that the gram-molecular volume of all gases at STP (i.e. atmospheric pressure and 0 °C or 273 K) is 22.4 litres. Therefore, applying the general gas equation to this condition

$$PV = RT$$

$$1 \times 22.414 = R \times 273$$

R can easily be calculated; and can be expressed in one of the following units:

$$R = \frac{PV}{T} = \frac{\text{Pressure} \times \text{Volume}}{\text{Temperature in degree absolute}}$$

where, Pressure as force per unit area = $\frac{\text{Force}}{\text{Area}} = \frac{\text{Force}}{\text{Length}^2}$, but
 volume = Length^3

Thus,

$$R = \frac{\frac{\text{Force}}{\text{Length}^2} \times \text{Length}^3}{\text{Degree}} = \frac{\text{Force} \times \text{Length}}{\text{Degree}}$$

But, Force x Length = Work

Hence,

$$R = \frac{\text{Work}}{\text{Degree}}$$

R is a constant for all gases when one mole of each of the gases is considered.

Thus,

$$R = \frac{\text{Work}}{\text{Degree} \times \text{Mole}}$$

Hence, the unit of R will be the unit of work or energy per degree per mole.

Energy can be expressed in litre atmosphere, in ergs, in joules or in calories.

Therefore, R can be expressed in:

Litre atmosphere degree⁻¹mol⁻¹
 Ergs degree⁻¹mol⁻¹
 Joules degree⁻¹mol⁻¹ or
 Calories degree⁻¹mol⁻¹

1. R in litre atmospheres degree⁻¹mol⁻¹ = 0.0821 litre atmospheres degree⁻¹mol⁻¹
2. R in ergs mol⁻¹degree⁻¹mol⁻¹

Erg is the centimeter–gram system (C.G.S) unit of energy and P and V are expressed in C.G.S units, viz dynes cm⁻² and ml respectively.

$P = 1 \text{ atm (76mm Hg whose density is } 13.6\text{gcm}^{-3}) = 76 \times 13.6 \times 980 \text{ dynes cm}^{-2}$ (980 is the acceleration due to earth's gravity)

$V = 22.414 \text{ litres} = 22414 \text{ ml} = 8.314 \times 10^7 \text{ ergsdegree}^{-1}\text{mol}^{-1}$

3. R in joules degree⁻¹mol⁻¹

$\therefore 1 \text{ joule} = 10^7 \text{ ergs}$

$\therefore R = 8.314 \text{ joules degree}^{-1}\text{mol}^{-1}$

4. R in calories degree⁻¹mol⁻¹

$4.814 \text{ joules} = 1 \text{ calorie}$

$= 1.988 \text{ Caldegree}^{-1}\text{mol}^{-1}$

Application

Using the general gas equation with the known value of R, the volume occupied by a known amount of a gas, at any specified temperature and pressure, can be calculated.

Example 10

Calculate the volume occupied by 8 g of oxygen at 20 °C and 10 atm pressure.

Solution

$$PV = nRT$$

where, V = volume occupied by n moles of the gas

8 g of O₂ = $\frac{8}{32}$ moles of O₂

Since number of moles of a substance = $\frac{\text{Mass of substance}}{\text{Its Molecular Mass}}$

$$\frac{8}{32} = \frac{1}{4}$$

Hence,

$$V = \frac{nRT}{P} = \frac{1}{4} \times \frac{0.0821 \times 293}{10} \text{ Litres} = 0.6015 \text{ Litres}$$

Therefore, volume of 8 g of O₂ at 20 °C and 10 atm is 0.6015 Litres

4.10 The Kinetic Molecular Theory of Gases

While all the principles of gas behaviour discussed so far have been arrived at by experimentation, the kinetic theory of gases on the other hand attempts to elucidate the behaviour of gases by theoretical means in terms of a postulated picture of a gas and certain assumptions regarding its behaviour. The kinetic theory is essentially based on the following fundamental postulates:

1. Every gas consists of a large number of separate tiny particles called molecules; and for any one gas all molecules have the same mass and size but differ in these only from gas to gas.
2. The molecules of a gas are in a state of constant rapid motion in all possible directions, traveling in straight lines until on collision with other molecule(s) or the wall of their container the direction of motion is changed.
3. The molecules exert no appreciable attraction on each other and hence behave as perfectly elastic bodies in which case there is no loss of kinetic energy after collision or mutual friction.
4. The pressure exerted by a gas is due to the bombardment of its molecules on the walls of its container.
5. The molecules are relatively small as compared to the distance between them. Hence they are assumed to be point masses.
6. Gravity does not impart any significant motion to the molecules as compared to the effect of the continued collision between them; and
7. The absolute temperature of a gas is a measure of the average kinetic energy of all the molecules present in it. That is, the average kinetic energy of the gas molecules is proportional to the absolute temperature of the gas.

According to kinetic theory of gases

$$\text{Kinetic energy, K.E.} = \frac{1}{2} nMC^2 \dots\dots\dots(30)$$

where, n = total number of molecules of a gas, m = mass of one molecule and c = average velocity of each molecule

4.11 Root Mean Square Velocity

If $V_1, V_2, V_3, V_4, V_5, \dots$ are the velocities of various individual molecules of a gas each possessing a mass, m, the kinetic energy of the individual molecules by definition will be

$$\frac{1}{2}mV_1^2, \frac{1}{2}mV_2^2, \dots \dots$$

$$\text{Total Kinetic Energy} = \frac{1}{2}mV_1^2 + \frac{1}{2}mV_2^2 + \dots \frac{1}{2}mV_n^2 \dots \dots (31)$$

Therefore, the average Kinetic Energy for n molecules is given as:

$$\text{Average K. E.} = \frac{\frac{1}{2}mV_1^2 + \frac{1}{2}mV_2^2 + \dots \frac{1}{2}mV_n^2}{n}$$

$$\text{Average K. E.} = \frac{1}{2} \frac{m}{n} \sum V^2 \dots \dots \dots (32)$$

If we assign a velocity C to a molecule such that $\frac{1}{2} MC^2$ is equal to the average K.E., then from Equation (32) becomes:

$$\text{Average K. E.} = \frac{1}{2} mc^2 = \frac{1}{2} \frac{m}{n} \sum V^2$$

Hence,

$$c^2 = \frac{1}{n} \sum V^2 = \frac{V_1^2 + V_2^2 + \dots + V_n^2}{n} \dots \dots \dots (33)$$

Taking square root of Equation (33), we have

$$c = \sqrt{c^2} = \sqrt{\frac{V_1^2 + V_2^2 + \dots + V_n^2}{n}} \dots \dots \dots (34)$$

C, being the square root of the mean of squares of velocities, is called root mean square velocity (rms velocity). It is such a velocity that $\frac{1}{2}M$ times its square is equal to average E_K of each molecule.

Mathematically,

$$c = \sqrt{c^2} = \sqrt{\frac{1}{n} \sum V^2} \dots \dots \dots (35)$$

Kinetic Equation for Gases

Consider n molecules of a gas with each having a mass m contained in a cubical vessel of length, l cm. Let C be the root mean square velocity of each molecule.

Although the molecules are moving in every possible direction, the velocity of a molecule at any moment can be resolved into three directions x, y and z parallel to the three edges of the cube. Since the molecules move in all directions and have no preference for any particular side, and since the pressure exerted after collision is the same on all sides, we may regard one-third molecules, $\frac{n}{3}$ moving parallel to any particular edge and striking the opposite face repeatedly.

Consider a molecule moving from left to right and on collision with the right hand side wall it then retraces its path. The collision is assumed to be perfectly elastic so that after the collision the magnitude of the velocity remains the same but its direction however changes (i.e. the velocity after collision will be C)

Momentum of the molecule before collision = mc

$$\begin{aligned}
\text{Momentum of the molecule after collision} &= mc \\
\text{Change in momentum per collision} &= mc - (-mc) \\
&= 2mc
\end{aligned}$$

In between two successive collisions, the molecule has to cover a distance of $2l$ cm, or when the molecule travels $2l$ cm it can make one collision with the right hand side wall of the cube. In one second the molecule can travel a distance of C cm. Therefore, the number of collisions of a molecule in one second is:

$$\frac{C}{2l}$$

Therefore, change in momentum in one second due to one molecule

$$\begin{aligned}
&= \frac{C}{2l} \times 2mC \\
&= \frac{mC^2}{l} \dots \dots \dots (36)
\end{aligned}$$

But, $\frac{1}{3}$ molecules are moving towards the same direction and striking the right hand side wall. Hence, the total change in momentum per second on the right hand side wall will be

$$\frac{mC^2}{l} \times \frac{n}{3} = \frac{1}{3l} nm C^2 \dots \dots \dots (37)$$

Similar changes in momentum are taking place on the 6 walls. Therefore, total change in momentum per second on all walls

$$= 6 \times \frac{1}{3l} nm c^2 \dots \dots \dots (38)$$

This change in momentum per second is the rate of change of momentum, which is equal to the force acting on the surface of the wall.

Therefore, total force acting on the 6 walls =

$$= \frac{1}{3l} nmc^2$$

This force is acting on a total area of $6l^2$ sq.cm

$$\text{Pressure} = \frac{\text{Total Force}}{\text{Total Area}} = \frac{6}{6l^2} = \frac{1}{3l^3} nmc^2$$

Hence,

$$\text{Pressure} = \frac{1}{3l^3} nmc^2 \dots \dots \dots (39)$$

But, $l^3 =$ volume of the cube = volume of gas (by definition)
Let this volume be V and pressure, P, hence

$$\text{Pressure, P} = \frac{1}{3V} nmc^2$$

Or

$$PV = \frac{1}{3} nmc^2 \dots \dots \dots (40)$$

Equation (40) is called kinetic gas equation.

Deductions of the Gas Laws from the Kinetic Theory

The gas laws can be explained by the kinetic theory and kinetic gas equation. In other words, the gas law equations can be derived from the kinetic theory and kinetic gas equation.

Boyle's Law

From kinetic theory, K.E. = $\frac{1}{2}mc^2$, where m = mass of 1 molecule and C its velocity.

According to kinetic theory.

$$\begin{aligned} \text{K.E.} &\propto T \\ \frac{1}{2}mc^2 &\propto T \end{aligned}$$

where, T = absolute temperature

Or

$$\frac{1}{2}mc^2 = KT$$

where, K = constant

According to kinetic gas equation,

$$PV = \frac{1}{3}nmc^2 = \frac{2}{2} \times \frac{1}{3}nmc^2$$

$$PV = \frac{2}{3} \times \frac{1}{2}nmc^2$$

But, $\frac{1}{2}nmc^2 = KT$

Thus,

$$PV = \frac{2}{3}nKT \dots \dots \dots (41)$$

Since Boyle's law holds true at constant temperature, it therefore means that at such condition (constant T), the expression on the right hand side of equation (41) will become constant for a fixed mass m of n molecules

That is,

$$\begin{aligned} PV &= \text{constant, at constant temperature} \\ &\text{(This is Boyle's law)} \end{aligned}$$

Charles Law

Recall Equation (41),

$$PV = \frac{2}{3}nKT \dots \dots \dots (41)$$

Thus,

$$V = \left(\frac{2}{3} \times \frac{nK}{P}\right) T \dots \dots \dots (42)$$

At constant pressure for a fixed mass of a gas the term within the bracket is a constant

$$V = \text{constant} \times T$$

Or

$$\frac{V}{T} = \text{constant, at constant pressure}$$

(This is Charles' Law)

Dalton's Law of Partial Pressures

Let there be 3 gases in a mixture of gases whose total kinetic energy is K.E., which is the sum of the K.E. of the three gases K.E₁ + K.E₂ + K.E₃.

For any gas,

$$K. E. = \frac{1}{2} mc^2$$

where, n = number of molecules of the gas and $PV = \frac{1}{3} mc^2$

Thus,

$$K. E. = \frac{3}{3} \times \frac{1}{2} mc^2 = \frac{3}{2} \times \frac{1}{3} mc^2$$

$$K. E. = \frac{3}{2} \times PV$$

Therefore,

$$K. E. = \frac{3}{2} PV \dots \dots \dots (43)$$

If the volume of the gas mixture is V and if the total pressure is P,

$$\text{Total K.E} = \text{K.E}_1 + \text{K.E}_2 + \text{K.E}_3$$

Hence,

$$\frac{3}{2}PV = \frac{3}{2}P_1V + \frac{3}{2}P_2V + \frac{3}{2}P_3V \dots\dots\dots(44)$$

Dividing Equation (44) through by V_1 , we get

$$P = P_1 + P_2 + P_3 \dots\dots\dots(44)$$

(Dalton's Law of partial pressure)

Graham's Law of Diffusion

According to the kinetic equation for gases, $PV = \frac{1}{3}mc^2$. For one mole of a gas having N (Avogadro's number) molecules, $nN = M$, the gram molecular mass

$$PV = \frac{1}{3}MC^2$$

Or

$$C^2 = \frac{3PV}{M} = \frac{3P}{\frac{M}{V}} = \frac{3P}{d}$$

(since density, $d = \frac{\text{Mass}}{\text{Volume}}$)

Thus,

$$C^2 = \frac{3P}{d}$$

This implies that,

$$C^2 \propto \frac{1}{d}, \text{ if } P \text{ is kept constant}$$

Hence,

$$C \propto \sqrt{\frac{1}{d}}$$

But the rate of diffusion (r) of a gas is directly proportional to the velocity (C) of molecules i.e. $r \propto c$.

Thus,

$$r \propto \sqrt{\frac{1}{d}}$$

(This is Graham's Law of Diffusion)

4.12 Real Gases

Unlike ideal gases discussed so far, real gases differ significantly. This is because the molecules of real gases possess volumes and they exert weak intermolecular forces of attraction. They do not obey the ideal gas equation i.e. they deviate from ideal gas behavior.

$$PV = nRT$$

This behaviour of real gases was first studied by Physicist Amagat. He studied the influence of pressure upon the volume of certain real gases such as H₂, He, CO and CH₄ at 0 °C. He plotted curves of pressure (P) against PV. For ideal gas behaviour the plot of P against PV should be a straight line parallel to the pressure axis since for all the values of pressure, PV is a constant for ideal gases. However, the actual plottings are of two types shown in Fig.4.5.

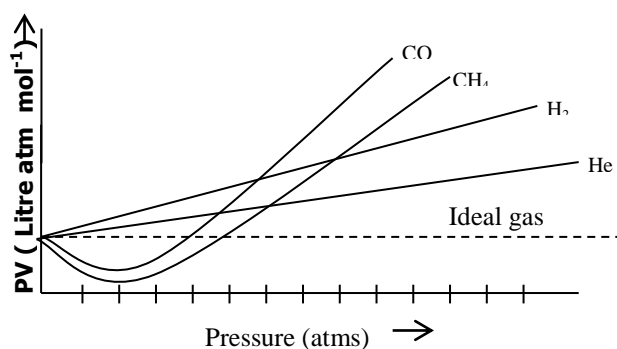

Figure 4.5: Deviation of real gases from gas laws

For H₂ and He the pV steadily increases with pressure; but in the case of CO and CH₄ the pV first decreases, then passes through a minimum value and then increases steadily with pressure. But when the temperature is increased CO and CH₄ behave like H₂ and He at 0 °C and when the temperature is reduced below certain temperatures H₂ and He resemble CO and CH₄ in behaviour at 0 °C. A particular temperature in which each of the gases obeys the ideal equation in a certain pressure range is called Boyle temperature.

Below its Boyle temperature the pV value of a gas is less than the expected value up to a certain pressure beyond which it is greater than the expected value. Above its Boyle temperature, pV value steadily increases with increase in pressure.

The above discussed phenomenon clearly shows that the general gas equation cannot account for the behaviour of gases under all conditions of temperature and pressure. Hence to make it fit for real gases, certain corrections must be made and this was first successfully done by Van der Waal and stated by an equation of state named after him: Van der Waal's equation of state, for one mole of a gas, is given as:

$$(P + a/v)(v - b) = RT \dots\dots\dots(46)$$

where, a, b are constants and p, V, T and R hold their usual meanings.

Van der Waal's Equation of State

The derivation of the ideal gas equation,

$$PV = nRT$$

From the kinetic theory of gases, a number of assumptions is given consideration, two of which are of valid significance here are:

- a. the volume of the molecules of a gas can be neglected when compared with the total volume of the gas, and
- b. that gas molecules have no intermolecular attraction

But both of these assumptions are not true at high pressures and low temperatures when the volume of the gas might have been considerably reduced and the intermolecular forces of attraction would have become appreciable. Van der Waal, therefore, modified the ideal gas equation so as to account for the invalidity of these two assumptions.

It is an observed fact that when a gas is subjected to high pressures at low temperatures it can be liquefied or even solidified. In the liquid or solid state the volume occupied by matter is due to the volumes of the fundamental particles viz molecules. These molecules are brought closer and closer together when the gas is subjected to high pressure until they are converted into the molecules of liquid or solid state where they have effective volume. So that at high pressures the volume occupied by gas molecules cannot be neglected.

Volume Correction

In the presence of effective volume called co-volume, b molecule travels in a space, which is equal to the observed volume less than the volume occupied by other molecules.

For one mole of a gas,

$$\begin{aligned} \text{Ideal volume} &= \text{Observed volume (V)} - \text{Co-volume (b)} \\ &= V - b \quad \dots\dots\dots(47) \end{aligned}$$

For n moles of a gas, the effective volume or Co-volume becomes nb

That is,

$$\text{Ideal volume} = V - nb \quad \dots\dots\dots(48)$$

The sudden expansion of a compressed gas into a low region of pressure is usually accompanied by cooling. This is called Joule-Thomson effect. The reduction in temperature due to cooling is well explained on the assumption of existence of forces of intermolecular attraction in a gas. When compressed the molecules are much closer to each other and are bound together by means of forces of attraction; but when it suddenly expands each molecule flies apart from the other molecules by doing work against the force of attraction. The easily available heat energy is used in doing this work and this leads to reduction in temperature.

Hence, there must be allowance for the forces of intermolecular attraction in the kinetic or general gas equation.

Pressure Correction

A molecule in the interior of a gas is attracted in all directions uniformly, and the forces acting in opposite direction cancel out each other. But a molecule approaching the walls of its container is subjected to an inward pull due to the unbalanced molecular attraction. It appears therefore that the instant any

molecule is about to strike the walls the molecules in bulk of the gas exert a force, which tends to pull it inwards. So that part of the energy of the molecule is used to overcome this inward pull and the force with which the molecules strike the wall will be less than the expected value. Since the pressure exerted is directly proportional to the force of bombardment, the observed pressure of any real gas will be less than that of an ideal gas. This implies that a correction term in terms of excess pressure should be added to the observed pressure to yield ideal pressure,

That is,

$$\text{Observed pressure} + \text{Pressure correction} = \text{Ideal pressure}$$

The correction term is derived from the presence of intermolecular force bonds, which make any real gas act as though it is subjected to a pressure in excess of the externally applied pressure. This excess pressure has been found to be inversely proportional to the square of the volume occupied by the gas

That is,

$$\text{Excess Pressure} \propto \left(\frac{1}{V}\right)^2 \text{ for one mole}$$

Or

$$\text{Excess Pressure} = \frac{a}{V^2} \dots \dots \dots (49)$$

where, a = a constant, which differs from gas to gas, V = volume occupied by gas.

For n moles of a gas,

$$\text{Excess Pressure} = \frac{n^2 a}{V^2} \dots \dots \dots (50)$$

Therefore,

Ideal Pressure = Observed Pressure + Excess Pressure

$$\text{Ideal Pressure} = \left(P + \frac{a}{V^2} \right) \text{ for one mole}$$

$$\text{Ideal Pressure} = \left(P + \frac{n^2 a}{V^2} \right) \text{ for } n \text{ moles}$$

In general,

$$\text{Ideal pressure} \times \text{Ideal Volume} = nRT$$

That is,

$$(P + a/V^2)(V - b) = RT \dots\dots\dots(51)$$

$$\left(P + \frac{n^2 a}{V^2} \right) (V - nb) = nRT \dots\dots\dots(52)$$

for n moles where, a and b are constants known as Van der Waal's constants and differ from gas to gas; P , V , R , T , n hold their usual meanings.

4.13 Liquefaction of Gases

This is a conversion of a gas into a liquid by a simultaneous application of high pressure and low temperature. A gas may be liquefied by:

- a. Reducing the temperature of its vapour to below its boiling point at normal pressure.
- b. Using an evaporating liquid to cool it below its critical temperature and then increasing the pressure (Cascade process)
- c. Cooling it by Joule–Kelvin expansion and using the cold gas to reduce the temperature of a gas which is about to expand. This is called regenerative cooling.
- d. Making it do external work in a nominally reversible adiabatic expansion (Claude's process). Or

- e. Combining Joule–Kelvin expansion with Claude’s process (Collin’s process).

However, certain gases like O_2 and H_2 can resist all attempts to be liquefied even at a temperature of the order of $-110\text{ }^\circ\text{C}$ no matter how great the applied pressure.

When a temperature of a gas is increased with pressure a point is reached at which the gas and its liquid co-exist i.e. the gas and its liquid become indistinguishable. This point is called the critical point. The temperature above, which a gas cannot be, liquefied however great the applied pressure is called the critical temperature of the gas. The inability to liquefy a gas above its critical temperature is due to the fact that the gas molecules are so far apart that intermolecular forces of attraction are not significant for effective liquefaction.

Thus, the critical temperature of a gas is the maximum temperature at which the gas can be liquefied by the application of high pressure.

The minimum pressure to be applied on a gas at its critical temperature so as to liquefy it is called its critical pressure.

The volume occupied by one gram-molecule or one mole of a gas or liquid at its critical temperature and critical pressure is known as its critical volume.

The critical temperature (T_c), critical pressure (P_c) and critical volume (V_c) of a substance are together known as its critical constants. Hence, it is often suggested that if a gas is to be liquefied by the application of high pressures it must be cooled below its critical temperature.

Methods of Liquefaction of Gases

There are generally several methods by which all gases can be liquefied, but two of which are worth mentioning are Linde's and Claude's methods. But here only Linde's method will be described.

Linde's Method of Liquefaction

The principle employed in this method is the Joule–Thomson Effect. Compressed gas, which is pre-cooled to the minimum possible temperature, is allowed to expand through a fine jet into a region of low pressure. As energy is expended to overcome the intermolecular forces of attraction during expansion at low pressure, the temperature of the gas decreases, thus, resulting further cooling condition. When this is repeated a number of times liquefaction of the gas is made possible.

In Linde's method, the gas is compressed by a pressure of 200 atmospheres and is pre-cooled. Then it is admitted into a coil tube as shown in the diagram in Figure 4.6.

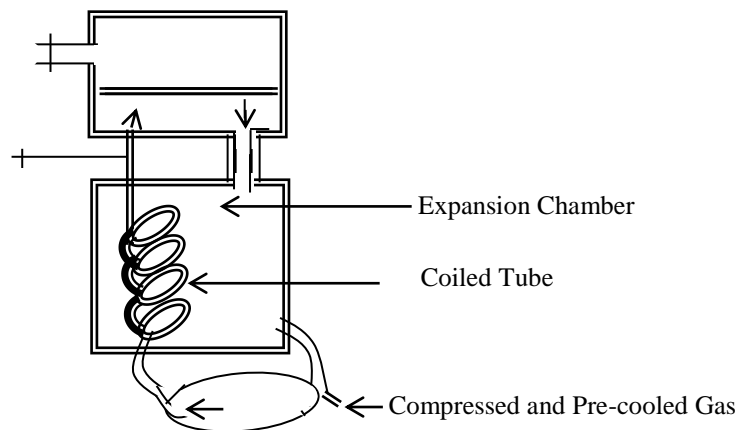

Figure 4.6: Linde's Process

By opening the expansion valve it is allowed to expand suddenly in the expansion chamber. The cooled gas, which escapes out, is again compressed by high pressure and the process is repeated until the gas gets liquefied in the expansion chamber.

CHAPTER FIVE

5.0 Chemical Equilibrium

Reversible chemical reactions are reactions that proceed in both directions. Consider a typical simple reaction:

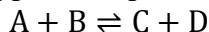

A and B are the reactants while C and D are the products. The double arrows, \rightleftharpoons simply indicates that the reaction is reversible. The double arrows give room for two possible reactions – forward and backward reaction, which occur under the same conditions.

If C and D are not allowed to escape, they will react to form A and B. This implies that the rate of the forward reaction becomes equal to the rate of the backward reaction, and thus, the reaction never goes into completion. This stage in a chemical reaction is known as equilibrium, and the reactants and the products involved in the state of equilibrium are called equilibrium mixtures.

Equilibrium is a dynamic process – the conversions of reactants to products and products to reactants are still going on, although there is no net change in the number of reactant and product molecules. This implies that, at equilibrium, no perceptible transformation can be observed in the system and the reaction appears to standstill, although, in reality, both the forward and backward reactions are proceeding at equal speeds at all time. Thus, chemical equilibrium is not static in nature, but dynamic.

5.1 Law of Mass Action

The law of mass action, as propounded by Gulberg, C.M. and Waage, P. in 1864, claims that every chemical species taking part in a reaction has an active mass. Active masses are now recognised as concentrations.

The law of mass action states that

“at constant temperature, the rate at which a substance reacts is directly proportional to its active mass, that is molar concentration”

Or

“the velocity of a chemical reaction is proportional to the products of the molar concentrations of the reactants at constant temperature”

If A, B, C and D are the equilibrium mixtures, where A and B are the reactants while C and D are the products, the law of mass action can be expressed mathematically as:

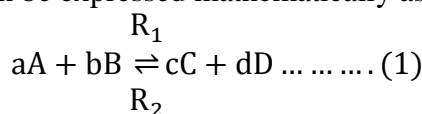

where, a, b, c and d are the coefficients of chemical species A, B, C and D respectively while R₁ and R₂ are rates of the forward and backward reactions.

5.2 Derivation of Equilibrium Constant

Recall Equation (1)

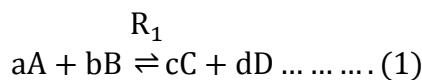

$$R_1 = K_1[A]^a[B]^b \dots \dots \dots (2)$$

$$R_2 = K_2[C]^c[D]^d \dots \dots \dots (3)$$

where, K₁ and K₂ are constants called rate constant.

At steady state equilibrium, R₁ = R₂

Hence,

$$K_1[A]^a[B]^b = K_2[C]^c[D]^d$$

$$\frac{K_1}{K_2} = \frac{[C]^c[D]^d}{[A]^a[B]^b} \dots \dots \dots (4)$$

But, $\frac{K_1}{K_2} = K_C =$ equilibrium constant

Thus Equation (4) becomes

$$K_C = \frac{[C]^c [D]^d}{[A]^a [B]^b} \dots \dots \dots (5)$$

Conventionally, the equilibrium concentrations of the substances appearing on the right hand side of the reaction (i.e. products) are always placed as the numerator while those of the substances on the left hand side (i.e. reactants) are always placed as denominator.

Equation (5) is the mathematical expression of the law of chemical equilibrium, which states that

“at any given temperature, the product of the concentrations of substances on the right hand side of a reaction divided by the product of concentrations of the substances on the left hand side is always a constant, which is called equilibrium constant, K_C ”

5.3 Types of Chemical Equilibrium

The two main types of chemical equilibrium are homogeneous equilibrium and heterogeneous equilibrium.

Homogeneous Equilibrium

This is the type where all the equilibrium mixtures are in the same gaseous or liquid state. the reactants and products of an aqueous solution are in liquid phase. An important fact about homogeneous reactions is that the mass action expression and the equilibrium law can always be predicted from the coefficients of the balanced chemical equation for the reaction.

Example 1

Write the equilibrium constants, K_C for the following reactions:

1. $N_2O_{4(g)} \rightleftharpoons 2NO_{2(g)}$
2. $N_{2(g)} + 3H_{2(g)} \rightleftharpoons 2NH_{3(g)}$

3. $\text{H}_{2(g)} + \text{I}_{2(g)} \rightleftharpoons 2\text{HI}_{(g)}$
4. $\text{C}_2\text{H}_5\text{OH}_{(aq)} + \text{CH}_3\text{COOH}_{(aq)} \rightleftharpoons \text{CH}_3\text{COOC}_2\text{H}_5_{(aq)} + \text{H}_2\text{O}_{(aq)}$

Solution

1. $\text{N}_2\text{O}_{4(g)} \rightleftharpoons 2\text{NO}_{2(g)}$

$$K_c = \frac{[\text{NO}_2]^2}{[\text{N}_2\text{O}_4]}$$

2. $\text{N}_{2(g)} + 3\text{H}_{2(g)} \rightleftharpoons 2\text{NH}_{3(g)}$

$$K_c = \frac{[\text{NH}_3]^2}{[\text{N}_2][\text{H}_2]^3}$$

3. $\text{H}_{2(g)} + \text{I}_{2(g)} \rightleftharpoons 2\text{HI}_{(g)}$

$$K_c = \frac{[\text{HI}]^2}{[\text{H}_2][\text{I}_2]}$$

4. $\text{C}_2\text{H}_5\text{OH}_{(aq)} + \text{CH}_3\text{COOH}_{(aq)} \rightleftharpoons \text{CH}_3\text{COOC}_2\text{H}_5_{(aq)} + \text{H}_2\text{O}_{(aq)}$

$$K_c = \frac{[\text{CH}_3\text{COOC}_2\text{H}_5][\text{H}_2\text{O}]}{[\text{C}_2\text{H}_5\text{OH}][\text{CH}_3\text{COOH}]}$$

Heterogeneous Equilibrium

When more than one phase exists in a reaction mixture, we call it a heterogeneous reaction. In other words, a heterogeneous equilibrium is such that its equilibrium mixtures are in more than one phase. This, however, permits the fact that for any pure liquid or solid, the ratio of amount of substance to volume of the substance is a constant. For instance, if one mole crystal of NaHCO_3 occupies a volume of 38.9 cm^3 , two moles of NaHCO_3 would occupy twice this volume, that is, 77.8 cm^3 . However, the ratio of moles to litres (i.e. molar concentration) remains the same.

Example 2

Write the equilibrium constants, K_C for the following reactions:

1. $2\text{Hg}_{(l)} + \text{Cl}_{2(g)} \rightleftharpoons \text{Hg}_2\text{Cl}_{2(s)}$
2. $2\text{Na}_{(s)} + 2\text{H}_2\text{O}_{(l)} \rightleftharpoons 2\text{NaOH}_{(aq)} + \text{H}_{2(g)}$
3. $\text{CaCO}_{3(s)} \rightleftharpoons \text{CaO}_{(s)} + \text{CO}_{2(g)}$

Solution

1. $2\text{Hg}_{(l)} + \text{Cl}_{2(g)} \rightleftharpoons \text{Hg}_2\text{Cl}_{2(s)}$

$$K = \frac{[\text{Hg}_2\text{Cl}_2]}{[\text{Hg}]^2[\text{Cl}_2]}$$
$$\frac{K[\text{Hg}]^2}{[\text{Hg}_2\text{Cl}_2]} = \frac{1}{[\text{Cl}_2]} = K_C$$

Therefore,

$$K_C = \frac{1}{[\text{Cl}_2]}$$

2. $2\text{Na}_{(s)} + 2\text{H}_2\text{O}_{(l)} \rightleftharpoons 2\text{NaOH}_{(aq)} + \text{H}_{2(g)}$

$$K = \frac{[\text{NaOH}]^2[\text{H}_2]}{[\text{Na}]^2[\text{H}_2\text{O}]^2}$$
$$\frac{K[\text{Na}]^2[\text{H}_2\text{O}]^2}{[\text{NaOH}]^2} = [\text{H}_2] = K_C$$

Therefore,

$$K_C = [\text{H}_2]$$

3. $\text{CaCO}_{3(s)} \rightleftharpoons \text{CaO}_{(s)} + \text{CO}_{2(g)}$

$$K = \frac{[\text{CaO}][\text{CO}_2]}{[\text{CaCO}_3]}$$
$$\frac{K[\text{CaCO}_3]}{[\text{CaO}]} = [\text{CO}_2] = K_C$$

5.4 Derivation of Equilibrium Constant at Constant Pressure, K_P

Fractions involving gases are conveniently expressed in terms of their partial pressure rather than their concentrations

Consider a general gaseous reaction,

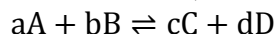

If P_A , P_B , P_C and P_D are the partial pressure of chemical species A, B, C and D, we have,

$$K_P = \frac{P_C^c \cdot P_D^d}{P_A^a \cdot P_B^b} \dots \dots \dots (6)$$

Equation (6) is valid for ideal gases.

5.5 Relationship Between K_C and K_P

The ideal gas law is given, mathematically, as

$$PV = nRT$$
$$P = \frac{nRT}{V} \dots \dots \dots (7)$$

where, P = partial pressure of gas, n = number of moles of gas, T = absolute temperature, R = gas constant and V = volume of gas

Equation (7) can be expressed as:

$$P = \frac{n}{V} \cdot RT \dots \dots \dots (8)$$

But, Concentration, $C = \frac{n}{V}$

Then,

$$P = CRT \dots \dots \dots (9)$$

Inserting Equation (9) into Equation (6), we have

$$K_P = \frac{C_C^c(RT)^c \cdot C_D^d(RT)^d}{C_A^a(RT)^a \cdot C_B^b(RT)^b} \dots \dots \dots (10)$$

$$K_P = \frac{[C]^c(RT)^c \cdot [C]^d(RT)^d}{[C]^a(RT)^a \cdot [C]^b(RT)^b}$$

$$K_P = \frac{[C]^c [C]^d (RT)^c (RT)^d}{[C]^a [C]^b (RT)^a (RT)^b}$$

$$K_P = \frac{[C]^c [C]^d (RT)^{c+d}}{[C]^a [C]^b (RT)^{a+b}}$$

$$K_P = \frac{[C]^c [C]^d}{[C]^a [C]^b} \cdot \frac{(RT)^{c+d}}{(RT)^{a+b}}$$

$$K_P = \frac{[C]^c [C]^d}{[C]^a [C]^b} \cdot (RT)^{(c+d)-(a+b)} \dots \dots \dots (11)$$

Inserting Equation (5) into Equation (11), we have

$$K_P = K_C (RT)^{(c+d)-(a+b)} \dots \dots \dots (12)$$

Equation (11) can be re-written as:

$$K_P = K_C (RT)^{\Delta n} \dots \dots \dots (13)$$

where, Δn = difference between the total number of moles of gaseous products and total number of moles of gaseous reactants during reaction.

Note that the values of Δn can be zero, positive and negative.

1. When $\Delta n = 0$, $K_P = K_C$;
2. When Δn is positive, $K_P > K_C$; and
3. When Δn is negative, $K_P < K_C$

5.6 Significance of K_C

The value of k is of great interest to chemists in that it is indicative of the yield of the products. The higher the value of k : the better the yield of the products and the reverse is the case when k value is lower.

Secondly, equilibrium conditions can only arise when the reacting system is enclosed so that none of the reactants or products escapes. However, if one or more of the products is continuously removed, then the reaction will continue to proceed to completion which is one way of increasing the yield for a reversible reaction. This principle is applied in many industrial processes. Example, in the manufacture of quicklime by heating limestone,



CO_2 is removed by a current of air so that all the limestone can be completely decomposed.

5.7 Relationship Between Free Energy (ΔG°) and Equilibrium Constant

Equilibrium constant (K) can be related to chemical thermodynamics in terms of Gibbs' free energy (G) by the expression:

$$\Delta G^\circ = -RT \ln K \dots\dots\dots(14)$$

But, $G = H - T\Delta S$ (at standard conditions) and $H = U + PV$

Hence,

$$G = U + PV - TS \dots\dots\dots(15)$$

For infinitesimal change in G

$$dG = dU + pdv + Vdp - Tds + SdT \dots\dots\dots(16)$$

If only expansion work is performed

$$dU = dq - pdv \dots\dots\dots(17)$$

and Equation (16) becomes

$$dG = dq - PdV + pdV + Vdp - Tds - SdT$$

$$dG = dq + Vdp - Tds - SdT \quad \dots\dots\dots (18)$$

For reversible reaction $dq = Tds$

Hence,

$$dG = Vdp - SdT \quad \dots\dots\dots(19)$$

In addition, if the change takes place isothermally, Equation (19) can be simplified to

$$dG = Vdp \quad \dots\dots\dots(20)$$

If pressure varies from P_1 to P_2 , Equation (20) may be integrated

$$dG = G_2 - G_1 = \int_{P_1}^{P_2} VdP$$

For ideal gas condition, $V = \frac{RT}{P}$

Hence,

$$G_2 - G_1 = \int_{P_1}^{P_2} \frac{dP}{P}$$

That is,

$$G_2 - G_1 = RT \ln \frac{P_2}{P_1} \quad \dots\dots\dots (21)$$

If state 1 represents the standard state then $P_1 = P^\circ$ and $G_1 = G^\circ$
 Putting $P_2 = P$ and $G_2 = G$, Equation (21) becomes

$$G - G^\circ = RT \ln \frac{P}{P^\circ} \quad \dots\dots\dots (22)$$

when $G = 0$, then

$$0 - G^\circ = RT \ln \frac{P}{P^\circ}$$

Hence,

$$G^\circ = -RT \ln \frac{P}{P^\circ} \dots \dots \dots (23)$$

Equation (23) can be re-written as

$$G^\circ = -RT \ln K \dots \dots \dots (24)$$

where, K = thermodynamic equilibrium constant in terms of the activities.

5.8 K_C and Spontaneity

Spontaneity is determined by the numerical value of the Gibb's free energy change (G°) of the reactants and products at their standard state and is measured by the equilibrium constant K.

That is,

$$G^\circ = -RT \ln K \dots \dots \dots (24)$$

1. If G° is negative, $\ln K$ will be positive. This implies that K is greater than one and thus, the reaction is spontaneous in the forward reaction;
2. If G° is positive, $\ln K$ will be negative. This implies that K is less than one and thus, the reaction is non-spontaneous in the forward reaction (but, spontaneous in the backward reaction); and
3. If G° is zero, $\ln K = 0$. This implies that $K = 1$ and the reaction is at equilibrium.

5.9 Properties of K_C and K_P

1. The expressions, K_C and K_P are valid only at equilibrium. This implies that constant values of K_C and K_P are obtained when the terms of concentration and pressure taken correspond to those at the point of equilibrium.

2. The value of equilibrium constant only varies with the temperature of the reaction and is constant at constant temperature.
3. The extent to which a reaction can take place can be predicted by knowing the value of the equilibrium constant. Larger values of K_C and K_P indicate large formation of product and that the reaction is more on the right side and vice versa. This is qualitative in nature.
4. Quantitatively speaking, the effect of change in concentration or pressure of reactants and products on the extent of reaction can as well be predicted.

5.10 Le Châtelier's Principle

One of the main goals of chemical synthesis is to maximize the conversion of reactants to products while minimizing the expenditure of energy. This objective is achieved easily if the reaction goes nearly to completion at mild temperature and pressure. If the reaction gives an equilibrium mixture that is rich in reactants and poor in products, however, then the experimental conditions must be adjusted.

Several factors can be exploited to alter the composition of an equilibrium mixture:

- The concentration of reactants or products can be changed
- The pressure and volume can be changed
- The temperature can be changed

The qualitative effect these changes on the composition of an equilibrium mixture can be predicted using a principle first described by the French chemist, Henri-Louis Le Châtelier (pronounced Li Sha-tell-yea).

It is worthy of note that catalysts do not affect the position of equilibrium of the system, but speed up the rate of attainment of equilibrium of the system.

Le Châtelier's Principle states that:

“if a change occurs in one of the variables, such as pressure, temperature or concentration, under which a system is in equilibrium, the system will always react in a direction, which will tend to counteract the effect of change in the variable under consideration”

OR

“If a system at equilibrium is disturbed by some change, the system will shift so as to partially counteract or annul the effect of the change”

OR

“If a stress is applied to a reaction mixture at equilibrium, net reaction occurs in the direction that relieves the stress”

A change in concentration, pressure, volume, or temperature disturbs the original equilibrium. Reaction then occurs to change the composition of the mixture until a new state of equilibrium is reached. The direction that the reaction takes (reactants to products or vice versa) is the one that reduces effect of the change.

Change in Concentration

In general, when an equilibrium is disturbed by the addition or removal of any reactant or product, Le Châtelier’s principle predicts that

- The concentration stress of an added reactant or product is relieved by net reaction in the direction that consumes the added substance.
- The concentration stress of a removed reactant or product is relieved by net reaction in the direction that replenishes the removed substance.

The Le Châtelier’s principle holds that

“If a reactant or product is added to a system at equilibrium, the system will shift away from the added component; if a reactant or product is removed from a system at equilibrium, the system will shift towards the removed component”

For clarity, consider the reaction,

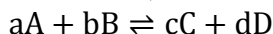

The equilibrium expression is

$$K_C = \frac{[C]^c [D]^d}{[A]^a [B]^b}$$

By adding D (or C) from outside:

- The C and D will combine to form more A and B. In other words, [C] and [D] decrease while [A] and [B] increase;
- Equilibrium will shift from right to left;
- The equilibrium constant, K_C , momentarily, is altered, becoming smaller. However, K_C value is restored as new equilibrium is reached, provided the temperature of the system remains unchanged.

Note: Opposite trends will be obtain if A (or B) is added from outside.

By removing D (or) from outside:

- The A and B will combine to form more A and B. In other words, [A] and [B] decrease while [C] and [D] increase;
- Equilibrium will shift from left to right;
- The equilibrium constant, K_C , momentarily, is altered, becoming larger. However, K_C value is restored as new equilibrium is reached, provided the temperature of the system remains unchanged.

Note: Opposite trends will be obtain if A (or B) is removed from outside.

Change in Pressure

There are two important factors to be considered in studying the effect of change in pressure on the position of equilibrium namely:

- All the chemical species must be in gaseous state. The implication is that change in pressure has no effect, when the chemical species are in phases other than gaseous. For instance, in the thermal decomposition of calcium trioxocarbonate (IV), change in pressure has no effect on its position of equilibrium, and the equilibrium constant



- Difference in the volumes of the reactants and the products. For a reaction in equilibrium with difference in the volumes of the reactants and the products, increase in pressure shifts the equilibrium to the direction accompanied by decrease in volume and vice versa.

For instance,

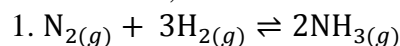

$$K_C = \frac{[\text{NH}_3]^2}{[\text{N}_2][\text{H}_2]^3}$$

Increase in pressure:

- Favours the forward reaction, implying the increase in the proportion of NH_3 with simultaneous decrease in the proportions of N_2 and H_2 . That is, equilibrium shifts from left to right.
- Momentarily, K_C is altered, which is restored as new equilibrium is reached, provided the temperature of the system is unchanged.

Decrease in pressure, however, favours the backward reaction.

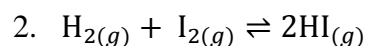

$$K_C = \frac{[\text{HI}]^2}{[\text{H}_2][\text{I}_2]}$$

Neither increase nor decrease in pressure has effect on the equilibrium of this system, because there is no difference in the volume of reactants and the products.

Change in Temperature

The effect of change in temperature on the position of equilibrium is clearly stated by Von't Hoff's Law of Mobile Equilibrium, which states that

“when a system is in equilibrium, raising the temperature will favour the reaction accompanied by absorption of heat (i.e. endothermic reaction) and lowering the temperature will favour the reaction accompanied by evolution of heat (i.e. exothermic reaction)”

Consider a reversible reaction,

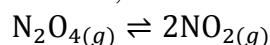

$$K_C = \frac{[\text{NO}_2]^2}{[\text{N}_2\text{O}_4]}$$

Forward reaction is endothermic, $\Delta H = +58.2 \text{ KJ}$ and the backward reaction is exothermic, $\Delta H = -58.2 \text{ KJ}$

Increase in temperature for the forward reaction, which is endothermic, results in:

- Increase in the formation of the product while the proportions of the reactants reduce.
- The equilibrium shifts from left to right.
- K_C becomes larger.

Conversely, increase in temperature for the backward reaction, which is exothermic, results in:

- Decrease in the formation of the product while the proportions of the reactants increase.
- The equilibrium shifts from right to left.

- K_C becomes smaller..

Note:

- The addition of a catalyst increases only the rate at which equilibrium is reached; it does not alter the position of equilibrium neither does it alter the equilibrium constant value.
- Changes in concentration and pressure affect the equilibrium position only; they do not, in reality, alter the equilibrium constant value of the system, provided the temperature of the system is kept constant.
- Change in temperature affects both the position of the equilibrium and the equilibrium constant value.

Example 3

Given

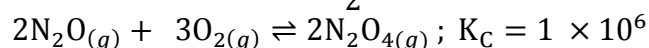
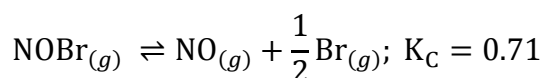

Calculate K_C for:

1. $2\text{NOBr}_{(g)} \rightleftharpoons 2\text{NO}_{(g)} + \text{Br}_{(g)}$
2. $\text{N}_2\text{O}_{(g)} + \frac{3}{2}\text{O}_{2(g)} \rightleftharpoons \text{N}_2\text{O}_{4(g)}$

Solution

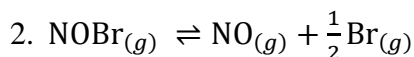

$$K_C = \frac{[\text{NO}][\text{Br}]^{\frac{1}{2}}}{[\text{NOBr}]}$$

Let x represent the equilibrium concentration of the mixture

Hence,

$$K_C = \frac{x \cdot x^{\frac{1}{2}}}{x} = 0.71$$

$$x^{\frac{1}{2}} = 0.71$$

$$x = (0.71)^2$$

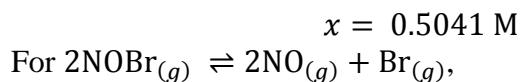

$$K_C = \frac{[\text{NO}]^2[\text{Br}]}{[\text{NOBr}]^2}$$

$$K_C = \frac{(0.5041)^2(0.5041)}{(0.5041)^2}$$

$$K_C = 0.5041 \text{ M}$$

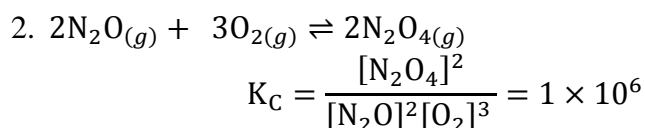

Let x represent the equilibrium concentration of the mixture
Hence,

$$K_C = \frac{x^2}{x^2x^3} = 1 \times 10^6$$

$$x^3 = 1 \times 10^{-6}$$

$$x = \sqrt[3]{1 \times 10^{-6}}$$

$$x = 0.01 \text{ M}$$

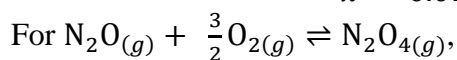

$$K_C = \frac{[\text{N}_2\text{O}_4]}{[\text{N}_2\text{O}][\text{O}_2]^{\frac{3}{2}}}$$

$$K_C = \frac{(0.01)}{(0.01)(0.01)^{\frac{3}{2}}}$$

$$K_C = 1 \times 10^3 \text{ M}$$

Note:

$$K_{C_1} = (K_{C_2})^x$$

where, x = coefficient multiplier

Example 4

Given the following K_P values at 25 °C;

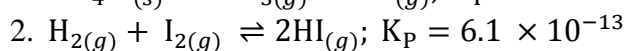
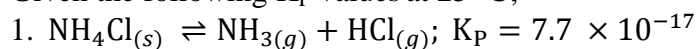

Calculate the corresponding values of K_C .

Solution

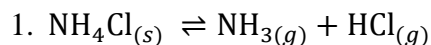

$$K_C = [\text{NH}_3][\text{HCl}]$$

$[\text{NH}_4\text{Cl}]$ is omitted for being a pure solid whose amount to volume remain constant.

But,

$$K_P = K_C(RT)^{\Delta n}$$

where,

$$K_P = 7.7 \times 10^{-17},$$

$$\Delta n = 1 + 1 = 2,$$

$$R = 0.0821 \text{ L.atm/mol.K}$$

$$T = 25 \text{ }^\circ\text{C} = 273 + 25 \text{ K} = 298 \text{ K}$$

$$K_C = ?$$

Hence,

$$7.7 \times 10^{-17} = K_C \times (0.0821 \times 298)^2$$

$$K_C = \frac{7.7 \times 10^{-17}}{(0.0821 \times 298)^2}$$

$$K_C = 1.286 \times 10^{-19}$$

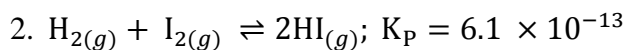

$$K_C = \frac{[\text{HI}]^2}{[\text{H}_2][\text{I}_2]}$$

But,

$$K_P = K_C(RT)^{\Delta n}$$

where,

$$\begin{aligned}
K_p &= 8.7 \times 10^2, \\
\Delta n &= 2 - (1 + 1) = 0, \\
R &= 0.0821 \text{ L.atm/mol.K} \\
T &= 25 \text{ }^\circ\text{C} = 273 + 25 \text{ K} = 298 \text{ K} \\
K_C &= ?
\end{aligned}$$

Hence,

$$\begin{aligned}
8.7 \times 10^2 &= K_C \times (0.0821 \times 298)^0 \\
8.7 \times 10^2 &= K_C \times 1
\end{aligned}$$

$$K_C = 8.7 \times 10^2$$

Example 5

The reversible reaction,

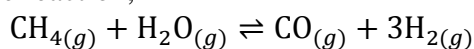

occurs at 500 °C, $K_C = 5.67$. If the equilibrium concentrations of CO, H₂ and CH₄ are 0.300 M, 0.800 M, 0.400 M, what is the equilibrium concentration of H₂O in the mixture?

Solution

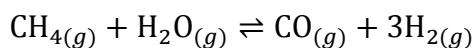

$$K_C = \frac{[\text{CO}][\text{H}_2]^3}{[\text{CH}_4][\text{H}_2\text{O}]} = 5.67$$

$$5.67 = \frac{(0.300)(0.800)^3}{(0.400)[\text{H}_2\text{O}]}$$

$$[\text{H}_2\text{O}] = \frac{(0.300)(0.800)^3}{(0.400)(5.67)}$$

$$[\text{H}_2\text{O}] = \frac{0.154}{2.27} = 0.0678 \text{ M}$$

Therefore, the equilibrium concentration of H₂O is 0.0678 M

Example 6

The reaction,

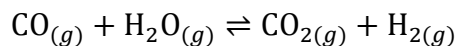

has $K_C = 4.06$ at $500\text{ }^\circ\text{C}$. If 0.100 mol of CO and 0.100 mol of H_2O are placed in a 1.00 litre reaction vessel at this temperature, what are the concentrations of the reactants and products at equilibrium?

Solution

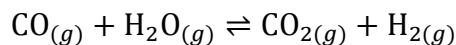

$$K_C = \frac{[\text{CO}_2][\text{H}_2]}{[\text{CO}][\text{H}_2\text{O}]} = 4.06 \text{ (at equilibrium)}$$

$$[\text{CO}]_{\text{initial}} = \frac{0.100}{1.00} = 0.100 \text{ M}$$

$$[\text{H}_2\text{O}]_{\text{initial}} = \frac{0.100}{1.00} = 0.100 \text{ M}$$

$$[\text{CO}_2]_{\text{initial}} = \frac{0.00}{1.00} = 0.00 \text{ M}$$

$$[\text{H}_2]_{\text{initial}} = \frac{0.00}{1.00} = 0.00 \text{ M}$$

If x represents change in concentration, then

$$[\text{CO}]_{\text{change}} = -x \text{ M}$$

$$[\text{H}_2\text{O}]_{\text{change}} = -x \text{ M}$$

$$[\text{CO}_2]_{\text{change}} = +x \text{ M}$$

$$[\text{H}_2]_{\text{change}} = +x \text{ M}$$

Then, equilibrium concentrations are

$$[\text{CO}]_{\text{equilibrium}} = 0.100 - x \text{ M}$$

$$[\text{H}_2\text{O}]_{\text{equilibrium}} = 0.100 - x \text{ M}$$

$$[\text{CO}_2]_{\text{equilibrium}} = x \text{ M}$$

$$[\text{H}_2]_{\text{equilibrium}} = x \text{ M}$$

Thus,

$$\frac{(x)(x)}{(0.100 - x)(0.100 - x)} = 4.06$$

$$\frac{x^2}{(0.100 - x)^2} = 4.06$$

Taking square root of both sides, we have

$$\sqrt{\frac{x^2}{(0.100 - x)^2}} = \sqrt{4.06}$$

$$\frac{x}{(0.100 - x)} = 2.01$$

$$x = 2.01(0.100 - x)$$

$$x = 0.201 - 2.01x$$

$$x + 2.01x = 0.201$$

$$3.01x = 0.201$$

$$x = \frac{0.201}{3.01}$$

$$x = 0.0668$$

Hence,

$$[\text{CO}]_{\text{equilibrium}} = 0.100 - x \text{ M} = 0.100 - 0.0668 \text{ M} = 0.033 \text{ M}$$

$$[\text{H}_2\text{O}]_{\text{equilibrium}} = 0.100 - x \text{ M} = 0.100 - 0.0668 \text{ M} = 0.033 \text{ M}$$

$$[\text{CO}_2]_{\text{equilibrium}} = x \text{ M} = 0.0668 \text{ M}$$

$$[\text{H}_2]_{\text{equilibrium}} = x \text{ M} = 0.0668 \text{ M}$$

Example 7

Phosphorus pentachloride vapour at 250 °C and 1 atm is 78.2% dissociated. What is:

1. the value of K_p ;

- the degree of dissociation at the same temperature at a pressure of 3 atm; and
- the partial pressure of each species at equilibrium?

Solution

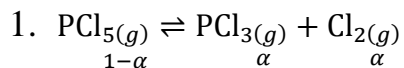

Total number of moles = $1 - \alpha + \alpha + \alpha = 1 + \alpha$

$$K_P = \frac{P_{\text{PCl}_3}^{\circ} \cdot P_{\text{Cl}_2}^{\circ}}{P_{\text{PCl}_5}^{\circ}}$$

But,

$$\text{Partial pressure, } P^{\circ} = \frac{X_{\text{individual}}}{X_{\text{total}}} \cdot P$$

where,

P° = partial pressure of individual constituent

P = total pressure of the mixture

$X_{\text{individual}}$ = number of moles of individual constituent

X_{total} = total number of moles of the constituents

Hence,

$$P_{\text{PCl}_3}^{\circ} = \left(\frac{\alpha}{1 + \alpha} \right) \cdot P$$

$$P_{\text{Cl}_2}^{\circ} = \left(\frac{\alpha}{1 + \alpha} \right) \cdot P$$

$$P_{\text{PCl}_5}^{\circ} = \left(\frac{1 - \alpha}{1 + \alpha} \right) \cdot P$$

$$\alpha = 78.2\% = 0.782$$

Thus,

$$K_P = \frac{\left(\frac{\alpha}{1+\alpha}\right) \cdot P \times \left(\frac{\alpha}{1+\alpha}\right) \cdot P}{\left(\frac{1-\alpha}{1+\alpha}\right) \cdot P} = \frac{\alpha^2 P}{1-\alpha^2}$$

$$K_P = \frac{\alpha^2 P}{1-\alpha^2}$$

$$K_P = \frac{0.782 \times 1}{1 - (0.782)^2} = 1.57$$

Therefore,

$$K_P = 1.57$$

2. Using,

$$K_P = \frac{\alpha^2 P}{1-\alpha^2}$$

where, $K_P = 1.57$, $P = 3$ atm and $\alpha = ?$

Thus,

$$1.57 = \frac{\alpha^2 \times 3}{1-\alpha^2}$$

Degree of dissociation, $\alpha = 0.586 = 58.6\%$

3. The partial pressure of each species at equilibrium is calculated as follows:

$$P_{\text{PCl}_3}^{\circ} = P_{\text{Cl}_2}^{\circ} = \left(\frac{\alpha}{1+\alpha}\right) \cdot P = \frac{0.586 \times 3}{1+0.586} = 1.108 \text{ atm}$$

$$P_{\text{PCl}_5}^{\circ} = \left(\frac{1-\alpha}{1+\alpha}\right) \cdot P = \frac{1-0.586}{1+0.586} \times 3 = 0.783 \text{ atm}$$

Questions

1. Write the equilibrium law for each of the following reactions in their concentration terms:

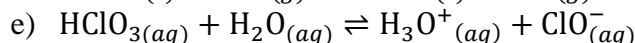
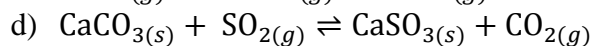
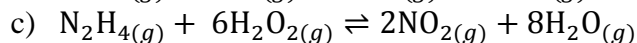
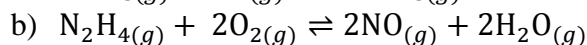
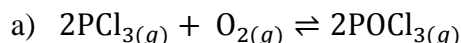

2. At 773 °C, the reaction

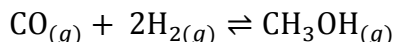

has $K_P = 5.4 \times 10^{-5}$. What is K_C at this temperature?

3. How will the position of equilibrium and K_C in the reaction
 $\text{Heat} + \text{CH}_{4(g)} + 2\text{H}_2\text{S}_{(g)} \rightleftharpoons \text{CS}_{2(g)} + 4\text{H}_2_{(g)}$
be affected by the following changes?

a) Adding $\text{CH}_{4(g)}$

b) Adding $\text{H}_2_{(g)}$

c) Removing $\text{CS}_{2(g)}$

d) Decreasing the volume of the container

e) Increasing the temperature

4. At 25 °C, 0.0560 mol O_2 and 0.020 mol N_2O were placed in a 1.00 L container where the following equilibrium was then established:

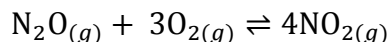

At equilibrium, the NO_2 concentration was 0.020 M. What is the value of K_C ?

5. The equilibrium constant, K_C for the reaction

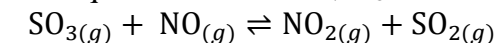

has been found to be 0.500 at a certain temperature. If 0.260 mol of SO_3 and 0.280 mol of NO are placed in a 2.00 L container and allowed to react, what will be the equilibrium concentration of each gas?

CHAPTER SIX

6.0 Acids and Bases

A single generalized definition of acid or base is difficult. Acids and bases have been defined in many ways each of which has its own characteristics, limitations and merits. In chemistry, acids and bases have been defined differently by three sets of theories. One is the Arrhenius definition, which revolves around the idea that acids are substances that ionize (break off) in an aqueous solution to produce hydrogen (H^+) ions while bases produce hydroxide (OH^-) ions in solution. On the other hand, the Bronsted-Lowry definition defines acids as substances that donate protons (H^+) whereas bases are substances that accept protons. Also, the Lewis theory of acids and bases states that acids are electron pair acceptors while bases are electron pair donors. Acids and bases can be defined by their physical and chemical observations.

Acids and bases are common solutions that exist everywhere. Almost every liquid that we encounter in our daily lives consists of acidic and basic properties, with the exception of water.

Table 6.1: Comparison of properties of acid and bases

S/N	Acid	Base
1	A piercing pain in a wound	Slippery feel
2	Sour tastes	Bitter taste
3	Colourless when placed in phenolphthalein (an indicator)	Pink when placed in phenolphthalein (an indicator)
4	Red on blue litmus paper (a pH indicator).	Blue on red litmus paper (a pH indicator)
5	pH<7.	pH>7
6	Evolution of hydrogen gas when reacted with	

	metals	
7	Evolution of carbon dioxide when reacted with carbonates	
8	Common examples: Lemons, oranges, vinegar, urine, sulfuric acid, hydrochloric acid	Common Examples: Soap, toothpaste, bleach, cleaning agents, limewater, ammonia water, sodium hydroxide.

6.1 The Arrhenius Definition

In 1884, the Swedish Chemist Svante Arrhenius proposed two specific classifications of compounds, termed acids and bases. When dissolved in an aqueous solution, certain ions were released into the solution.

Arrhenius Acids

An Arrhenius acid is a compound that increases the concentration of H^+ ions that are present when added to water. These H^+ ions form the hydronium ion (H_3O^+), when they combine with water molecules. This process is represented in a chemical equation by adding H_2O to the reactants side.

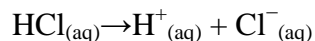

In this reaction, hydrochloric acid (HCl) dissociates into hydrogen (H^+) and chlorine (Cl^-) ions when dissolved in water, thereby releasing H^+ ions into solution. Formation of the hydronium ion equation:

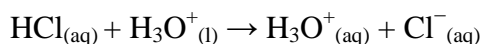

Incomplete Ionization (Weak Acids)

Strong acids are molecular compounds that essentially ionize to completion in aqueous solution, disassociating into H^+ ions and

the additional anion; there are very few common strong acids. All other acids are "weak acids" that incompletely ionized in aqueous solution.

Table 6.2: Strong and weak acids

Strong Acids	HCl, HNO ₃ , H ₂ SO ₄ , HBr, HI, HClO ₄
Weak Acids	All other acids, such as HCN, HF, H ₂ S, HCOOH

Arrhenius Bases

An Arrhenius base is a compound that increases the concentration of OH⁻ ions that are present when added to water. The dissociation is represented by the following equation:

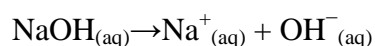

In this reaction, sodium hydroxide (NaOH) disassociates into sodium (Na⁺) and hydroxide (OH⁻) ions when dissolved in water, thereby releasing OH⁻ ions into solution. The stronger the acid and base, the more dissociation will occur.

Incomplete Ionization (Weak Bases)

Like acids, strong and weak bases are classified by the extent of their ionization. Strong bases disassociate almost or entirely to completion in aqueous solution. Similar to strong acids, there are very few common strong bases. Weak bases are molecular compounds where the ionization is not complete.

Table 6.3: Strong and weak acids and bases

Strong base	The hydroxides of the Group I and Group II metals such as LiOH, NaOH, KOH, RbOH, CsOH
Weak base	All other bases, such as NH ₃ , CH ₃ NH ₂ , C ₅ H ₅ N

Limitations to the Arrhenius Theory

The Arrhenius theory has many more limitations than the other two theories. The theory suggests that in order for a substance to release either H^+ or OH^- ions, it must contain that particular ion. However, this does not explain the weak base ammonia (NH_3), which in the presence of water, releases hydroxide ions into solution, but does not contain OH^- itself.

Hydrochloric acid is neutralised by both sodium hydroxide solution and ammonia solution. In both cases, we get a colourless solution which can be crystallised to get a white salt - either sodium chloride or ammonium chloride. These are clearly very similar reactions. The full equations are:

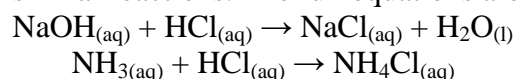

In the sodium hydroxide case, hydrogen ions from the acid are reacting with hydroxide ions from the sodium hydroxide in line with the Arrhenius theory. However, in the ammonia case, there are no hydroxide ions!

We can say that the ammonia reacts with the water it is dissolved in to produce ammonium ions and hydroxide ions:

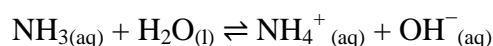

This is a reversible reaction, and in a typical dilute ammonia solution, about 99% of the ammonia remains as ammonia molecules. Nevertheless, there are hydroxide ions there, and we can squeeze this into the Arrhenius theory. However, this same reaction also happens between ammonia gas and hydrogen chloride gas.

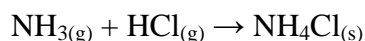

In this case, there are not any hydrogen ions or hydroxide ions in solution, because there is no any solution. The Arrhenius theory would not count this as an acid-base reaction, despite the fact that it is producing the same product as when the two substances were in solution. Because of this short-coming, later

theories sought to better explain the behaviour of acids and bases in a new manner.

6.2 The Brønsted-Lowry Definition

In 1923, British Chemists Johannes Nicolaus Brønsted and Thomas Martin Lowry independently developed definitions of acids and bases based on the compounds' abilities to either donate or accept protons (H^+ ions).

In this theory, acids are defined as proton donors whereas bases are defined as proton acceptors. A compound that acts as both a Bronsted-Lowry acid and base together is called amphoteric. This took the Arrhenius definition one step further, as a substance no longer needed to be composed of hydrogen (H^+) or hydroxide (OH^-) ions in order to be classified as an acid or base.

Consider the following chemical equation:

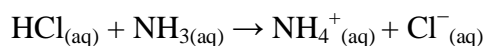

Here, hydrochloric acid (HCl) "donates" a proton (H^+) to ammonia (NH_3) which "accepts" it, forming a positively charged ammonium ion (NH_4^+) and a negatively charged chloride ion (Cl^-). Therefore, HCl is a Brønsted-Lowry acid (donates a proton) while the ammonia is a Bronsted-Lowry base (accepts a proton). Also, Cl^- is called the conjugate base of the acid HCl and NH_4^+ is called the conjugate acid of the base NH_3 .

6.3 Lewis Theory

The Lewis theory of acids and bases states that acids act as electron pair acceptors and bases act as electron pair donor. This definition does not mention anything about the hydrogen atom at all, unlike the other definitions. It only talks about the transfer of electron pairs. To demonstrate this theory, consider the following example:

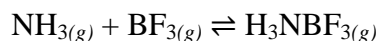

This is a reaction between ammonia (NH_3) and boron trifluoride (BF_3). Since there is no transfer of hydrogen atoms here, it is clear that this is a Lewis acid-base reaction. In this reaction, NH_3 has a lone pair of electrons and BF_3 has an incomplete octet, since boron doesn't have enough electrons around it to form an octet.

This is considered an acid-base reaction where NH_3 (base) is donating the pair of electrons to BF_3 . BF_3 (acid) is accepting those electrons to form a new compound, H_3NBF_3 .

6.4 Neutralization and Hydrolysis

A special property of acids and bases is their ability to neutralize the other's properties. In an acid-base (or neutralization) reaction, the H^+ ions from the acid and the OH^- ions from the base react to create water (H_2O). Another product of a neutralization reaction is an ionic compound called a salt. Therefore, the general form of an acid-base reaction is:

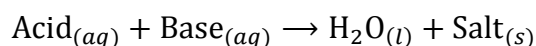

The following are examples of neutralization reactions:

1. $\text{HCl}_{(aq)} + \text{NaOH}_{(aq)} \rightarrow \text{H}_2\text{O}_{(l)} + \text{NaCl}_{(s)}$
2. $\text{H}_2\text{SO}_{4(aq)} + 2\text{NH}_4\text{OH}_{(aq)} \rightarrow \text{H}_2\text{O}_{(l)} + (\text{NH}_4)_2\text{SO}_{4(s)}$

Since the acid, base and salt formed are invariably fully ionized (strong electrolyte) neutralization can also be defined as the union of H^+ and OH^- to form the undissociated water molecule. Neutralization is the key reaction in Acid-Base titration. At complete neutralization (at end point) the titrated solution is expected to be neutral. This is not always so due to a secondary reaction between the salt formed and water to reform the parent acid and base only. This reverse reaction is called HYDROLYSIS. Since the salt and acid, and base formed are

invariably ionized, hydrolysis can also be defined as the dissociation of water into H^+ and OH^- . Thus, hydrolysis is the reverse of neutralization.

6.5 pH Scale

A pH scale is a measure of how acidic or basic a substance is. While the pH scale formally measures the activity of hydrogen ions in a substance or solution, it is typically approximated as the concentration of hydrogen ions. However, this approximation is applicable only under low concentrations.

The pH scale is often referred to as ranging from 0-14 or perhaps 1-14. Neither is correct. The pH range does not have an upper nor lower bound, since as defined above, the pH is an indication of concentration of H^+ . For example, at a pH of zero the hydronium ion concentration is one molar, while at pH 14 the hydroxide ion concentration is one molar. Typically the concentrations of H^+ in water in most solutions fall between a range of 1 M (pH=0) and 10^{-14} M (pH=14). Hence a range of 0 to 14 provides sensible (but not absolute) "bookends" for the scale. However, in principle, one can go somewhat below zero and somewhat above 14 in water, because the concentrations of hydronium ions or hydroxide ions can exceed one molar.

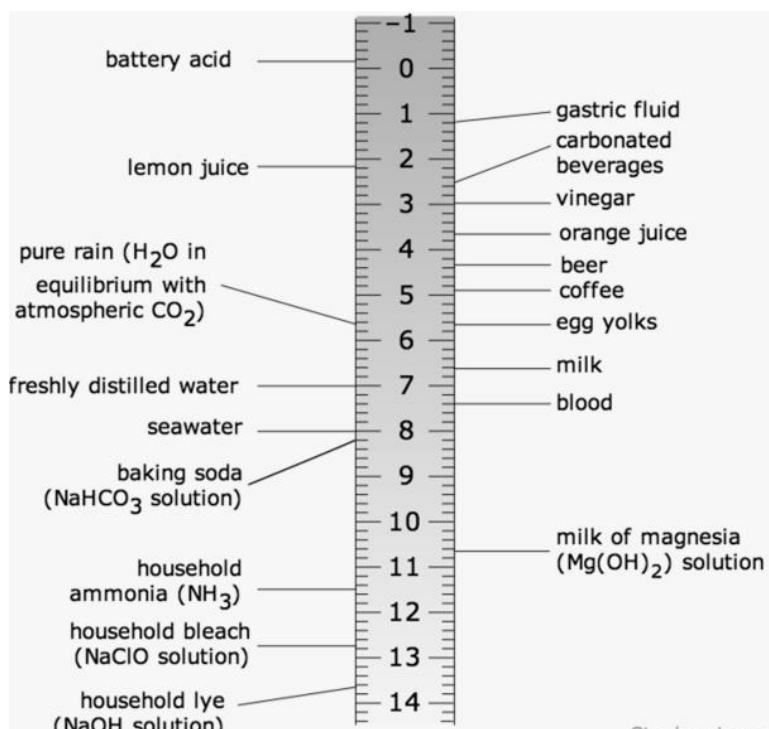

Figure 6.1: Solutions and the placement of them on pH scale

- From the range 7-14, a solution is basic. The pOH should be looked in the perspective of OH⁻ instead of H⁺. Whenever the value of pOH is greater than 7, then it is considered basic. And therefore there are more OH⁻ than H⁺ in the solution
- At pH 7, the substance or solution is at neutral and means that the concentration of H⁺ and OH⁻ ion is the same.
- From the range 1-7, a solution is acidic. So, whenever the value of a pH is less than 7, it is considered acidic. There are more H⁺ than OH⁻ in an acidic

6.6 Self-Ionization of Water

The pH scale is logarithmic, meaning that an increase or decrease of an integer value changes the concentration by a

tenfold. For example, a pH of 3 is ten times more acidic than a pH of 4. Likewise, a pH of 3 is one hundred times more acidic than a pH of 5. Similarly a pH of 11 is ten times more basic than a pH of 10. Because of the amphoteric nature of water (i.e., acting as both an acid or a base), water does not always remain as H₂O. In fact, two water molecules react to form hydronium and hydroxide ions:

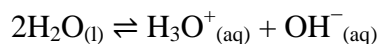

This is also called the self-ionization of water. The concentration of H₃O⁺ and OH⁻ are equal in pure water, because of the stoichiometric ratio. The molarity of H₃O⁺ and OH⁻ in water are also both 1.0×10⁻⁷ M at 25 °C. Therefore, a constant of water (K_w) is created to show the equilibrium condition for the self-ionization of water. The product of the molarity of hydronium and hydroxide ion is always 1.0×10⁻¹⁴.

$$K_w = [\text{H}_3\text{O}^+][\text{OH}^-] = 1.0 \times 10^{-14}$$

This equation also applies to all aqueous solutions. However, K_w does change at different temperatures, which affects the pH range.

Note: H⁺ and H₃O⁺ is often used interchangeably. The equation for water equilibrium is:



- If an acid (H⁺) is added to the water, the equilibrium shifts to the left and the OH⁻ ion concentration decreases
- If base (OH⁻) is added to water, the equilibrium shifts to left and the H⁺ concentration decreases

6.7 pH and pOH

Because the constant of water, K_w is always 1.0 X 10⁻¹⁴, the pK_w is 14, the constant of water determines the range of the pH

scale. To understand what the pK_w is, it is important to understand first what the "p" means in pOH, and pH. The danish biochemist Soren Sorenson proposed the term pH to refer to the "potential of hydrogen ion." He defined the "p" as the negative of the logarithm, $-\log$, of $[H^+]$. Therefore the pH is the negative logarithm of the molarity of H. The pOH is the negative logarithm of the molarity of OH^- and the pK_w is the negative logarithm of the constant of water. These definitions give the following equations:

$$pH = -\log_{10} [H^+]$$

$$pOH = -\log_{10} [OH^-]$$

$$pK_w = -\log_{10} [K_w]$$

$$pK_w = pH + pOH = 14$$

Example 1

If the concentration of NaOH in a solution is 2.5×10^{-4} M, what is the concentration of H_3O^+ ?

Solution

Because $1.0 \times 10^{-14} = [H_3O^+][OH^-]$,

To find the concentration of H_3O^+ , solve for the $[H_3O^+]$

$$(1.0 \times 10^{-14})/[OH^-] = [H_3O^+]$$

$$(1.0 \times 10^{-14})/(2.5 \times 10^{-4}) = [H_3O^+] = 4.0 \times 10^{-11} \text{ M}$$

Example 2

- 1) Find the pH of a solution of 0.002M of HCl.
- 2) Find the pH of a solution of 0.00005M NaOH.

Solution

1. The equation for $pH = -\log [H^+]$

$$[H^+] = 2.0 \times 10^{-3} \text{ M}$$

$$\text{pH} = -\log [2.0 \times 10^{-3}] = 2.70$$

2. The equation for pOH is $-\log [\text{OH}^-]$
 $[\text{OH}^-] = 5.0 \times 10^{-5} \text{ M}$
 $\text{pOH} = -\log [5.0 \times 10^{-5}] = 4.30$
 $\text{pK}_w = \text{pH} + \text{pOH}$ and $\text{pH} = \text{pK}_w - \text{pOH}$
 Then $\text{pH} = 14 - 4.30 = 9.70$

Example 3

If soil has a pH of 7.84, what is the H^+ concentration of the soil solution?

Solution

$$\text{pH} = -\log [\text{H}^+]$$

$$7.84 = -\log [\text{H}^+]$$

$$[\text{H}^+] = 1.45 \times 10^{-8} \text{ M}$$

6.8 Buffers

A buffer is one which has a particular pH value and retains the value of pH in spite of all possible contamination by an acid or a base. In other words, a buffer is a solution that can resist pH change upon the addition of an acidic or basic component. It is able to neutralize small amounts of added acid or base, thus maintaining the pH of the solution relatively stable. This is important for processes and/or reactions which require specific and stable pH ranges. Buffer solutions have a working pH range and capacity which dictate how much acid/base can be neutralized before pH changes, and the amount by which it will change.

Consider the dissociation of ethanoic acid,



The dissociation constant, K_a is given as

$$K_a = \frac{[\text{CH}_3\text{COO}^-][\text{H}^+]}{[\text{CH}_3\text{COOH}]} \dots \dots \dots (1)$$

From Equation (1),

$$[\text{H}^+] = K_a \cdot \frac{[\text{CH}_3\text{COOH}]}{[\text{CH}_3\text{COO}^-]} \dots \dots \dots (2)$$

Since $[\text{CH}_3\text{COOH}] = [\text{Acid}]$ and $[\text{CH}_3\text{COO}^-] = [\text{Salt}]$, Equation (2) can be written as

$$[\text{H}^+] = K_a \cdot \frac{[\text{Acid}]}{[\text{Salt}]} \dots \dots \dots (3)$$

Taking Equation (3) to $-\log_{10}$, we have

$$-\log_{10}[\text{H}^+] = -\log_{10} \left(K_a \cdot \frac{[\text{Acid}]}{[\text{Salt}]} \right)$$

$$\text{pH} = -\log_{10} K_a - \log_{10} \left(\frac{[\text{Acid}]}{[\text{Salt}]} \right)$$

$$\text{pH} = \text{p}K_a - \left[-\log_{10} \left(\frac{[\text{Salt}]}{[\text{Acid}]} \right) \right]$$

$$\text{pH} = \text{p}K_a + \log_{10} \left(\frac{[\text{Salt}]}{[\text{Acid}]} \right) \dots \dots \dots (4)$$

Equation (4) is known as Henderson-Hasselbalch Equation.

Example 4

Calculate the pH value of a solution which is 0.05 M with respect to CH_3COOH and 0.20 M with respect to CH_3COONa , given that the dissociation constant, K_a of CH_3COOH is $2 \times 10^{-5} \text{ mol/dm}^3$.

Solution

$$\text{pH} = \text{pK}_a + \log_{10} \left(\frac{[\text{Salt}]}{[\text{Acid}]} \right)$$

where,

$$\text{pH} = ?$$

$$\text{K}_a = 2 \times 10^{-5} \text{ mol/dm}^3$$

$$[\text{Salt}] = 0.20 \text{ M}$$

$$[\text{Acid}] = 0.05 \text{ M}$$

Hence,

$$\text{pH} = -\log_{10}(2 \times 10^{-5}) + \log_{10} \left(\frac{0.20}{0.05} \right)$$

$$\text{pH} = -(-4.699) + 0.6021$$

$$\text{pH} = 4.699 + 0.6021$$

$$\text{pH} = 5.3011$$

$$\text{pH} = 5.30 \text{ to } 3 \text{ s. f.}$$

6.9 Theory of Indicator

The functions of indicator are to:

- detect acidity or basicity
- detect end point of a neutralization

Most indicators are weak acids. At end point an aqueous solution of the corresponding salt dissolves; for strong acid and base the pH will have a value of about 7. But either of the solution is weak acid or base, the salt will be hydrolysed to a certain degree and solution at the end point will be either slightly acidic or alkaline.

The major characteristic of these indicators is that the change from acid colour to a basic colour is not sudden but takes place within a small interval of pH and this interval of pH is called colour change interval of indicator.

Since these indicators are very weak acid, there is a marked difference of colour between the undissociated molecules and the anions.



In summary, pH indicator is a weak acid or base which within certain limit changes colour with the pH of its environment.

In choosing an indicator for titration, the indicator range should lie within the end point pH range of the titrated solution, since pH interval over which an indicator changes colour is usually about 2 units and the position of this interval on the pH scale depends on the nature of the indicator itself.

Ostward Theory of Indicator

Ostward Theory of Indicator indicates that the change in colour of organic compound often involve intramolecular structural re-arrangement with or without ionization. Modern theory shows that there is equilibrium between two-tautomeric forms of the undissociated indicator itself, which always differs in colour. That an ion of each tautomer usually has the same colour as the tautomer from which it is derived.

Consider methyl orange indicator and the two tautomeric form can be represented as HMO (an acid yellow) and MOH (base red). The following tautomeric and ionic equilibrium exist simultaneously:

a) Tautomeric equilibrium

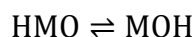

b) Ionic Equilibrium

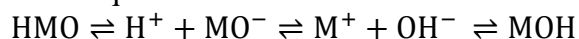

Both HMO and MO are yellow and both M^+ and MOH are red.

Thus, in terms of colour changes the essential equilibrium is

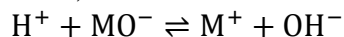

If excess H^+ are present, the equilibrium is driven to the left hence methyl orange is yellow in base.

Table 6.4: Indicators, colours and pH values

Indicator	Colour	pH
Phenolphthalein	Purple Colourless	10.8
Methyl red	Yellow Pink	6.4
Methyl orange	Yellow Pink	5.3

It is possible to blend a mixture of indicator such that the resultant mixture of indicator range covers the whole pH scale of 1 – 14. Such an indicator is called Universal indicator.

Choice of Indicator for Titration

For this to be properly done the indicator range of available indicator must be known and the pH of the titrated solution at end point must also be known.

- For strong acid/strong base – Any indicator because the pH range or solution at end point cover the whole pH range.

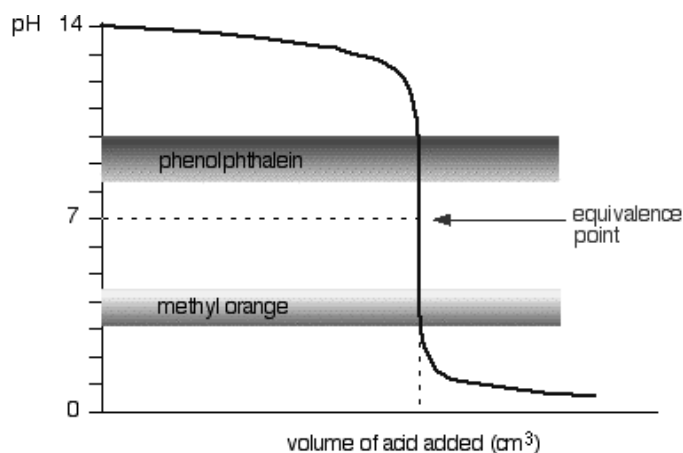

Figure 6.2: pH curve for strong acid and strong base

- Strong acid and weak base – Methyl orange because indicator pH range lies on the acidic scale, and titrated solution is acidic due to hydrolysis of the salt.

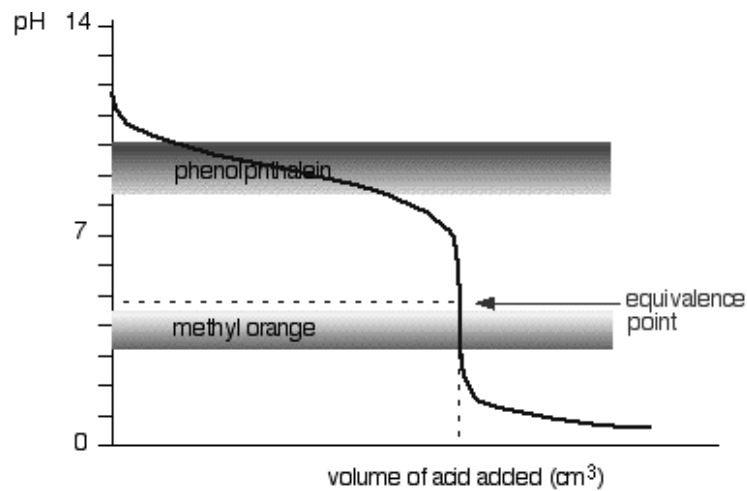

Figure 6.3: pH curve for strong acid and weak base

- Weak acid/strong base – phenolphthalein indicator pH range lies on alkaline side and titrated solution is alkaline due to hydrolysis of salt of strong base.

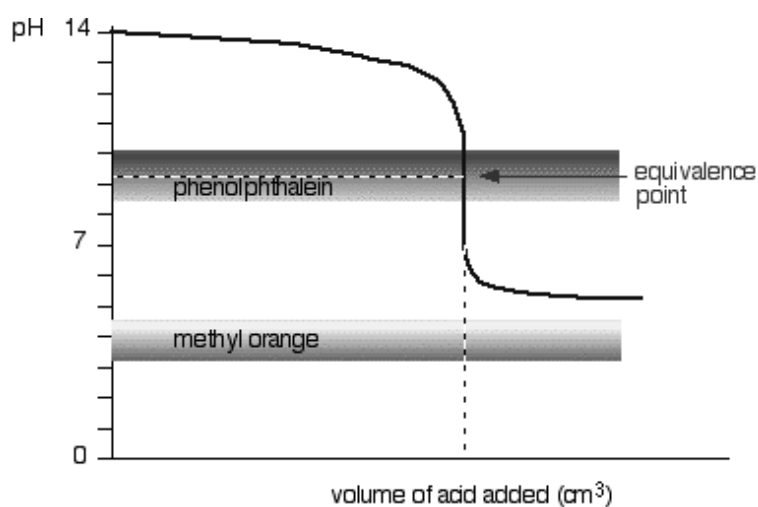

Figure 6.4: pH curve for weak acid and strong base

- Weak acid/weak base – No indicator is suitable, since there is no range of pH for the solution at the end point.

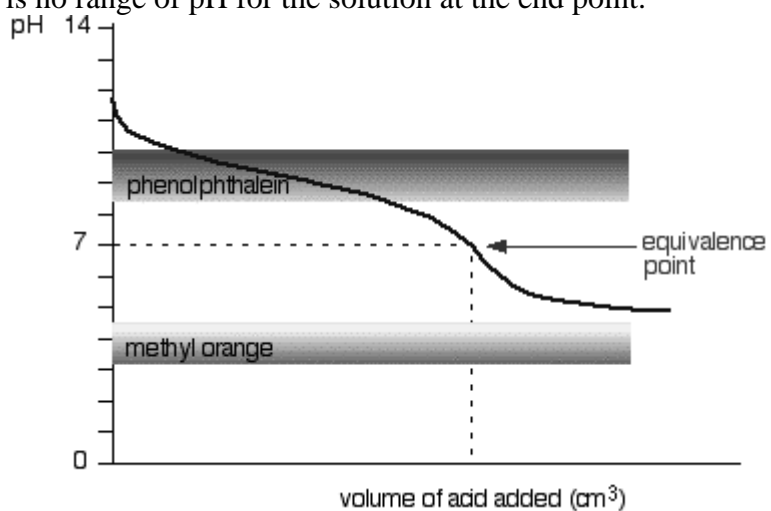

Figure 6.4: pH curve for weak acid and weak base

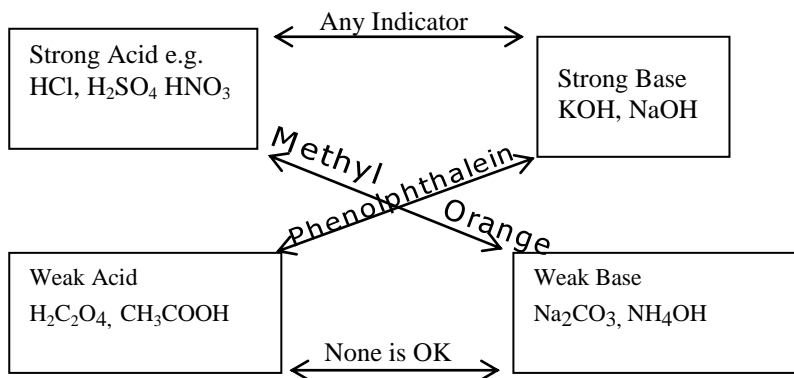

Figure 6.2: Schematic representation of choice of indicator for titration

CHAPTER SEVEN

7.0 Chemical Thermodynamics

Thermodynamics is mainly concerned with the Law governing the inter conversion of various types of energy and its relationship with work.

There are three Laws and these laws can be stated in mathematical form, which enable far-reaching conclusion to be made regarding the limitations of energy interconversion and hence thermodynamics is an exact science.

Whereas the First Law of thermodynamics deals with the equivalence of different forms of energy, the second Law is concerned with the direction of chemical change and condition of equilibrium. The two Laws deal with changes in thermodynamic variables (temperature, pressure, volume and number of moles). The third Law, which is beyond the scope of this course, attempts to evaluate thermodynamics parameters.

The First and Second Laws led to the development of the concept of energy and entropy. Before attempting to give the statements of the first two laws of thermodynamics, it is pertinent to first define some important thermodynamics terms.

7.1 System

A thermodynamics system is any part of the physical universe chosen for the purpose of experimental or theoretical investigation and separated from the surroundings by a boundary. The three types of thermodynamic system are isolated, closed and open systems.

- An isolated system is one in which there is no transfer of either energy or matter across the boundary (i.e. $dE = 0$ and $dm = 0$).

- In a closed system, there is transfer of energy but not of matter across the secondary, ($dE \neq 0$) and $dm = 0$).
- In an open system both matter and energy are transferred across the boundary, $dE \neq 0$ and $dm \neq 0$.

7.2 Thermodynamic Variables

Various measurable properties of the system which define the system completely are temperature pressure, volume and mole, are called thermodynamic variables or state variables.

Thermodynamic Functions

These are products of mathematical manipulation of thermodynamic variables. The functions obtained from this are simpler (Table 7.1).

Table 7.1: Thermodynamic functions

Function	Name	Definitions
E	Internal Energy	$DE = dq - dw$
S	Entropy	$dS = dq_{rev}/T$
H	Enthalpy	$H = E + PV$
G	Gibb's free energy	$G = H - TS$
A	Helmholtz free energy	$A = E - TS$
C_p	Heat Capacity at constant pressure	$C_p = \frac{(\partial H)}{(\partial T)_p}$
C_v	Heat Capacity at constant vol.	$C_v = \frac{(\partial H)}{(\partial T)_v}$

Thermodynamic function are state functions and can be defined as any properties of a system which are independent of how a change is accomplished but are dependent only upon the initial and final state i.e. they depend only on the initial and final

states of the system. All thermodynamic function viz. E, H, S, G, A are state function so are PV and T but, q and w are not state function, since they depend on the path through which the change takes place as well as on the initial and final state of the system.

7.3 Law of Thermodynamics

First Law of Thermodynamics

The change in internal energy (dE) in any given system is the difference between the heat entering the system (dq) and the work done by the system (dw). For an isolated system, the internal energy is constant and $dq = 0 = dw$.

Mathematically, the first law can be expressed as

$$dE = dq - dw \dots\dots\dots(1)$$

where,

dE = infinitesimal amount of heat absorbed by the system;

dw = work done by the system;

For finite changes,

$$\Delta E = q - w$$

Heat Changes at Constant Volume

From first law equation

$$\Delta E = q - w$$

Or

$$q = \Delta E + w \dots\dots\dots(2)$$

If work done is due to expansion against pressure,

$$q = \Delta E + P\Delta V$$

If volume is constant and the change in volume ΔV is zero, so that no expansion occurs then.

$$q_v = \Delta E \text{ (Since } P\Delta V = 0\text{)}$$

i.e. heat absorbed at constant volume is equal to the energy increase accompanying the process.

Heat Changes at Constant Pressure

If only P – V work is done and the pressure is constant, the first law equation can be written as

$$\Delta E = q_p - P\Delta V \dots\dots\dots(3)$$

Or

$$E_2 - E_1 = q_p - P(V_2 - V_1)$$

Or

$$q_p = (E_2 - PV_2) - (E_1 + PV_1) \dots\dots\dots(4)$$

Since the heat absorbed is given by the difference of the two quantities, which are state function, it is convenient to introduce a new state function, the enthalpy H which is defined as:

$$H = E + PV \dots\dots\dots(5)$$

Equation (4) may be written as

$$q_p = H_2 - H_1 = \Delta H$$

Therefore, the heat absorbed in a process at constant pressure is equal to the change in enthalpy if the work done is pressure – volume work.

Heat Capacity

This is defined as the rate of change of heat with temperature for a substance. If the amount of heat is 1g then it is called the specific heat capacity and if it is 1 mole it is called the molar

specific heat capacity. The heat change can be measure under the conditions of either constant volume or constant pressure i.e. (C_V) and (C_P).

From the First Law of thermodynamics, heat capacity at constant volume can be defined as:

$$C_V = \frac{dq_V}{T} = \frac{\partial E}{(\partial T)_V} \dots \dots \dots (6)$$

Heat capacity at constant pressure, C_P

$$C_P = \frac{dq_P}{T} = \frac{\partial H}{(\partial T)_P} \dots \dots \dots (7)$$

Relationship Between C_p and C_v

If only expansion work is performed, then at constant pressure for an infinitesimal change.

$$dH = dE + PdV \dots \dots \dots (8)$$

For an ideal gas, the restriction on constant volume and pressure may be eliminated since E and H are independent of pressure and volume and depend only on the temperature. Hence

$$dE = C_v dT \text{ and } dH = C_p dT \dots \dots \dots (9)$$

Substitution of these in Equation (8), we have

$$C_p dT = C_v dT + PdV \dots \dots \dots (10)$$

For one mole of an ideal gas the general gas equation becomes

$$PdV = RT$$

If volume and temperature change at constant pressure, then,

$$PdV = RdT$$

And Equation (10) becomes

$$C_p dT = C_v dT + RdT \dots\dots\dots(11)$$

Dividing Equation (11) through by dT, we get

$$C_p = C_v + R. \text{ (This equation relates } C_p \text{ to } C_v)$$

where, R is the universal gas constant.

7.4 Second Law of Thermodynamics

This Law may be stated

“as any process, which occurs in nature, is accompanied by increase in total entropy.”

Or

“that in an isolated system the direction of change is such that the entropy increases to a maximum at equilibrium then entropy is constant.”

This second Law enable one to determine whether or not a given process is likely to occur.

For an isolated system:

- dS net positive indicates that the process proceeds spontaneously in the forward direction.
- dS net zero indicates that the process is in equilibrium.
- dS net negative indicates that the process proceeds spontaneously in the reverse direction.

Mathematically, the second Law can be expressed as

$$q_{\text{rev}} = T\Delta S$$

where,

S = entropy,

q_{rev} = Heat absorbed or evolved,

T = Temperature

The equation, $dS = \frac{dq_{\text{rev}}}{T}$ can be used to calculate entropy, S

Example 1

Calculate the entropy change involved in the conversion of 1 mole of ice at 0 °C and 1 atm to liquid at 0 °C and 1 atm, the enthalpy of fusion per mole of ice is 6008 Jmol⁻¹

Solution

The process is reversible, so

$$\Delta S_{\text{F}} = \frac{\Delta H_{\text{F}}}{\Delta T_{\text{F}}} = \frac{6008 \text{ J mol}^{-1}}{273.15\text{K}}$$

$$\Delta S_{\text{F}} = 22.0 \text{ JK}^{-1} \text{ mol}^{-1}$$

This is an increase in the entropy of the system. At the same time the heat lost by the surrounding would be

$$\begin{aligned} \Delta S &= \frac{-6008}{273.15} \text{ JK}^{-1} \text{ mol}^{-1} \\ &= -22.0 \text{ JK}^{-1} \text{ mol}^{-1} \end{aligned}$$

For both system and surroundings,

$$\begin{aligned} S_{(\text{system})} + S_{(\text{Surr.})} &= \Delta S_{(\text{total})} \\ 22.0 + (-22.0) &= 0 \end{aligned}$$

Therefore, the entropy change in an isolated reversible process is zero.

7.5 Combined Form of First and Second Laws of Thermodynamics

According to First Law,

$$dq = dE + PdV \dots\dots\dots(1)$$

According to Second Law,

$$dS = \frac{dq_{rev}}{T}$$

Or

$$dq_{rev} = TdS \dots\dots\dots(2)$$

Combination of equation (1) and (2) gives

$$TdS = dE + PdV$$

Or

$$dE = TdS - PdV \dots\dots\dots(3)$$

Equation (3) is the combined form of first and second laws of thermodynamics.

Under constant volume condition, Equation (3) becomes,

$$dE = TdS \dots\dots\dots(4)$$

When Equation (4) is integrated,

$$\int dE = \int TdS$$

We get,

$$E = Ts + A \dots \dots \dots (5)$$

where, A is a constant of integration and is called Helmholtz free energy function.

Relationship between Enthalpy and Entropy

Enthalpy is expressed as

$$H = E + PV$$

And for infinitesimal change it becomes,

$$dH = dE + VdP + PdV \dots \dots \dots (6)$$

Using Equation (3) above, Equation (6) becomes

$$dH = TdS + VdP \dots \dots \dots (7)$$

Equation (7) indicates that enthalpy (H) is a function of entropy (S) and pressure. It clearly shows that the change in enthalpy (dH) depends on the changes in entropy (dS) and pressure dP.

At constant pressure Equation (7) becomes

$$dH = TdS \dots \dots \dots (8) \text{ Since } (Vdp = 0 \text{ as } dp = 0)$$

On integration of Equation (8),

$$\int dE = \int TdS$$

Given as a function of

$$H = TS + G \dots \dots \dots (9)$$

where, G is the integration constant and is the same as Gibb's free energy function.

For Gibb's free energy function, $dG = dH - TdS$

For Gibb's Free Energy

For infinitesimal change,

$$G = H - TS \quad (dT = 0)$$

For a finite change,

$$dG = dH - TdS$$

$$\Delta G = \Delta H - T\Delta S.$$

Spontaneity of a system at constant temperature and pressure and depends on the numerical value of ΔG i.e. it tells whether the system is spontaneous, non-spontaneous and at equilibrium.

- When $\Delta G = 0$, system is at equilibrium ($\Delta H = T\Delta S$);
- When $\Delta G > 0$; system is spontaneous or irreversible;
- When $\Delta G < 0$; system will be theoretically non spontaneous

CHAPTER EIGHT

8.0 Oxidation Reduction Reactions

This is also called REDOX reactions, and represents another way of classifying reactions. Oxidation–reduction reactions are two processes that are opposing to each other. They are yet complementary to each other. An oxidation reaction is always accompanied by a reduction reaction, and a reduction reaction is always accompanied by an oxidation reaction. They are the two sides of the same fundamental chemical change. An oxidation–reduction is abbreviated as a redox reaction.

Oxidation and reduction are terms that have several definitions.

8.1 In Terms of Oxygen

When oxygen is added to a substance, the substance is said to have been oxidized. For example, when Magnesium is burned in Oxygen, it is said to be oxidized

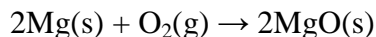

Carbon also is oxidized when it burns in oxygen.

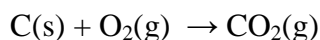

Carbon is also oxidized when it reacts with Zinc Oxide, ZnO.

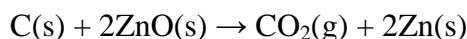

The reverse process, i.e. the removal of oxygen from a substance is known as reduction. In the reaction between carbon and zinc oxide, oxygen was removed from zinc oxide. Therefore, we say that zinc oxide has undergone reduction. Another example is the reaction between copper (ii) oxide and hydrogen.

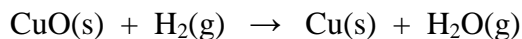

In the reaction, oxygen is removed from copper (II) oxide and added to hydrogen. In the reaction, we say that hydrogen has undergone oxidation while copper (II) oxide underwent reduction. In the above reaction, both reduction and oxidation reactions took place.

So far we have explained oxidation as a process, which involves the addition of oxygen to a substance while reduction is a process that involves the removal of oxygen from a substance.

8.2 In Terms of Hydrogen

There are some reactions that do not involve the addition or removal of oxygen. In such reactions, oxidation and reduction are explained in terms of the transfer of hydrogen. For example, the reaction between hydrogen sulphide and chlorine.

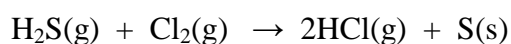

In the above reaction, hydrogen is removed from hydrogen sulphide and added to chlorine. So we say that hydrogen sulphide has undergone oxidation while chlorine has undergone reduction.

When ammonia burns in oxygen:

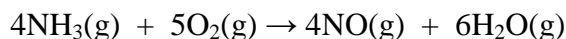

In this reaction, hydrogen is removed from ammonia i.e. nitrogen loses its hydrogen and at the same time oxygen is added to it. Ammonia, we can say has undergone oxidation.

We can now define oxidation–reduction reactions in terms of oxygen and hydrogen as:

There are some reactions that do not involve the addition or removal of oxygen. In such reactions, oxidation and reduction are explained in terms of the transfer of hydrogen. For example, the reaction between hydrogen sulphide and chlorine.

Oxidation is

- The gain of oxygen
- The loss of hydrogen

Similarly, reduction is

- The loss of oxygen
- The gain of hydrogen

8.3 In Terms of Electrons

There are reactions, which do not involve oxygen or hydrogen. In such reactions, we consider the changes that occur in the bonding of the compounds during oxidation and reduction. Consider the reaction,

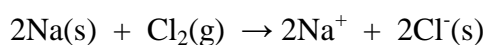

In the reaction neutral sodium atoms are converted to sodium ions, Na^+ , and neutral chlorine molecules are converted into chloride ions, Cl^- . In this reaction electrons are transferred. Sodium atom loses an electron while a chlorine atom gains an electron.

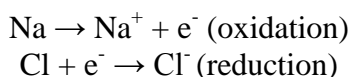

Consider also the reaction in which Magnesium is oxidized to Magnesium Oxide.

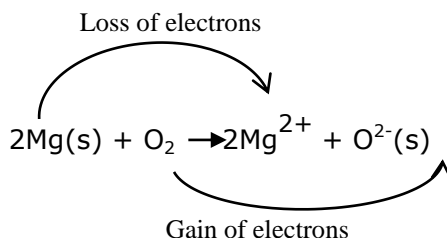

In the reaction, neutral magnesium atoms lose two electrons each in an oxidation reaction to form magnesium ions, Mg^{2+}

and neutral oxygen molecules are converted to oxide ions, O^{2-} in a reduction reaction.

We thus define oxidation as a process that involves the loss of electrons and reduction as a process that involves the gain of electrons.

Oxidation is

- The gain of oxygen
- The loss of hydrogen
- The gain of electrons

Similarly, Reduction is

- The loss of oxygen
- The gain of hydrogen
- The loss of electrons

8.4 Oxidizing and Reducing Agents

A substance that is used to oxidize another is called an oxidizing agent. In the process, itself is reduced. A substance that is used to reduce another is called a reducing agent, and in the process, itself is oxidized.

Some common oxidizing and reducing agents are listed in Table 8.1.

Table 8.1: Some common oxidizing and reducing agents

Oxidizing Agent	Reducing Agent
Oxygen, O_2	Hydrogen, H_2
Chlorine, Cl_2	Carbon, C
Dichromate (VI) ions $Cr_2O_7^{2-}$	Sulphur (IV) Oxide, SO_2
Manganate (VII) ions MnO_4^-	Hydrogen Sulphide, H_2S
Hydrogen peroxide, H_2O_2	Iron (II) Salt, Fe^{2+}
Concentrated trioxonitrate (v) acid NO_3^-	Potassium iodide, K I

The terms oxidizing agent and reducing agents are used in relative terms. A chemical normally called an oxidizing agent will itself be oxidized if it comes in contact with a more powerful oxidizing agent. For example, chlorine usually behaves as an oxidizing agent, but when it reacts with fluorine, chlorine is oxidized because fluorine is a more powerful oxidizing agent than chlorine. In this case, chlorine acts as the reducing agent.

8.5 Oxidation Numbers

Oxidation numbers are useful in the study of redox reactions. Oxidation numbers are also sometimes called oxidation states. They help us to keep record of electrons in redox reactions. The oxidation number of an element in a molecule or ion (a particular compound) is the charge it carries as defined by a set of rules. In assigning oxidation numbers to elements in a compound, it is assumed that all compounds are ionic. In a reaction, when a substance gains electrons, its oxidation number decreases while if it loses electrons its oxidation number increases.

Rules for Assigning Oxidation Numbers

The following are a set of rules for assigning oxidation numbers:

- The oxidation number of an atom in an element (i.e. uncombined elements) is 0. For example, the oxidation number of the atoms in Na, O₂, O₃.
- The oxidation number of a mono atomic ion is equal to the charge on the ion. For example, the oxidation numbers of the following Na⁺, Mg²⁺, O²⁻.
- In covalent compounds with non-metals, hydrogen has oxidation number of 1 except when it is bonded to metals (i.e. in metallic hydrides) where it is -1. For

example, NH_3 , HCl , H_2O , CH_4 ; hydrogen is +1 but in LiH , NaH etc, hydrogen is -1 . In its covalent compounds, such as CO_2 , SO_2 , H_2O , Oxygen has oxidation number of -2 . But in peroxides, such as H_2O_2 , Na_2O_2 , oxygen has oxidation number of -1 .

- In its covalent compounds, such as CO_2 , SO_2 , H_2O , Oxygen has oxidation number of -2 . But in peroxides, such as H_2O_2 , Na_2O_2 , oxygen has oxidation number of -1 .
- In binary compounds, the more electronegative element is assigned a negative oxidation number that is equal to its charge in its ionic compounds. In this case fluorine is always -1 , in HF iodine is -1 ; in ICl , Chlorine is -1 ; and iodine is $+1$. Nitrogen is always -3 for example in NH_3 , nitrogen is -3 ; and so on.
- The sum of the oxidation numbers of the atoms in an electrically neutral compound is always 0 . But for anionic specie, the sum is equal to the charge on the ion. For example, in H_2SO_4 , the sum of the oxidation numbers for the hydrogen, sulphur and oxygen atoms is 0 ; the sum of the oxidation numbers of the sulphur and oxygen atoms in SO_3^{2-} is -2 ; and the sum of the oxidation numbers of the nitrogen and hydrogen atoms in NH_4^+ is $+1$.

An element may exhibit more than one oxidation number, the oxidation numbers of the transition metals are shown in Table 8.2.

Table 8.2: Oxidation numbers exhibited by some elements

Oxidation Number	Chromium	Manganese	Iron	Nitrogen	Sulphur
+7		MnO_4^-			
+6	CrO_4^{2-}	MnO_4^{2-}	FeO_4^{2-}		SF_6
+5				NO_3^-	
+4		MnO_2		NO_2	SO_2
+3	CrCl_3	Mn(OH)_3	Fe_2O_3	NCl_3^-	
+2	CrCl_2	MnCl_2	FeO_2	NO	
+1				N_2O	
0	Cr	Mn	Fe	NO_2	
-1					S
-2					H_2S
-3				NH_3	

Calculating Oxidation Numbers in Ions and Molecules

Here, we shall do some examples, to show how to work out the oxidation numbers of elements.

Example 1

Calculate the oxidation number of phosphorus in PO_4^{3-} .

Solution

We use the facts stated in the rules for assigning oxidation numbers. In compounds oxygen is -2 and that the sum of all the oxidation numbers of the phosphorus and oxygen is equal to -3 .

$$[\text{Oxidization number of P}] + [4 \times \text{oxidation number of O}] = -3$$

$$\text{P} + (4 \times -2) = -3$$

$$\text{P} - 8 = -3$$

$$P = -3 + 8$$

$$P = +5$$

Therefore, oxidation number of Phosphorus in $\text{PO}_4^{-3} = +5$

Example 2

Calculate the oxidation number of chromium in $\text{Cr}_2\text{O}_7^{2-}$

Solution

$$\begin{aligned} & [2 \times \text{oxidation number of chromium}] \\ & + [7 \times \text{oxidation number of oxygen}] = -2 \end{aligned}$$

$$(2 \times \text{Cr}) + (7 \times 2) = -2$$

$$(2\text{Cr}) + (-14) = -2$$

$$2\text{Cr} - 14 = -2$$

$$2\text{Cr} = -2 + 14$$

$$2\text{Cr} = +12$$

$$\text{Cr} = \frac{+12}{2}$$

$$\text{Cr} = +6$$

Therefore, oxidation number of Chromium in $\text{Cr}_2\text{O}_7^{2-} = +6$

Example 3

Calculate the oxidation number of sulphur in H_2SO_4 .

Solution

H_2SO_4 is a neutral molecule, therefore the sum of the oxidation number of the elements = 0

$$[2 \times \text{oxidation number of hydrogen}]$$

$$\begin{aligned}
& +[\text{Oxidation number of sulphur}] \\
& + [4 \times \text{oxidation number of oxygen}] = 0 \\
& (2 \times \text{H}) + (\text{S}) + (4 \times -2) = 0 \\
& 2 + \text{S} + (-8) = 0 \\
& \text{S} - 8 + 2 = 0 \\
& \text{S} - 6 = 0 \\
& \text{S} = +6
\end{aligned}$$

Therefore, oxidation number of sulphur in $\text{H}_2\text{SO}_4 = +6$

Oxidation Numbers and Redox Equations

A Redox reaction is one in which reduction and oxidation reactions take place simultaneously. In the reaction between sodium and Chlorine,

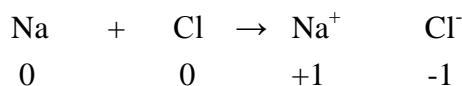

The oxidation number of sodium changes from 0 to +1. This involves the loss of electron. On the other hand the oxidation number of Chlorine changes from 0 to -1. This represents the gain of one electron.

As rule oxidation involves an increase in oxidation number while reduction involves a decrease in oxidation number.

In order to determine whether a reaction is a redox one, we look at the changes in oxidation numbers of the reactants and products.

Consider, for example, the reaction between potassium chloride and silver trioxonitrate (v) solution.

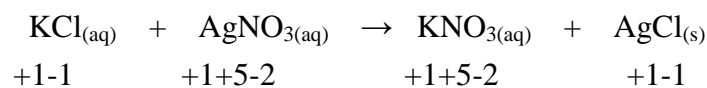

In the reaction, there are no changes in the oxidation numbers of the elements. No species is oxidized and none is reduced. The reaction therefore is not a redox reaction, but merely a precipitation reaction (an ion-exchange reaction).

In the reaction between hydrogen sulphide and sulphur (IV) oxide,

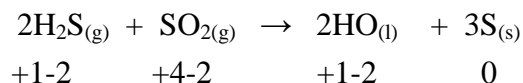

There are changes in oxidation numbers. The oxidation number of sulphur in hydrogen sulphide increases from 2 to 0 in elemental sulphur. The oxidation number of sulphur in sulphur (IV) oxide decreases from +4 to 0 in elemental sulphur. Therefore, hydrogen sulphide is oxidized while sulphur (IV) oxide is reduced. Hence, the reaction is a redox reaction.

Balancing Oxidation–Reduction Reactions

Oxidation reduction reactions are often difficult to balance by mere inspection. Here, we shall consider one method of balancing redox equations. This method involves the use of oxidation numbers in half-reactions.

The oxidation half-equation shows the release (loss) of electrons while the reduction-half reaction shows the acceptance of electrons. The procedure is to separate the reaction into two half reaction, and balance them separately and then add them together to obtain an overall balanced equation.

The method still differs slightly, depending on whether the reaction is taking place in an acidic medium.

- Write down separately the equations for the oxidation and reduction half-reactions.

- For the separate half-reactions:
 - Balance all the elements except hydrogen and oxygen.
 - Balance oxygen by adding appropriate number of moles of H₂O to the side deficient in oxygen.
 - Balance hydrogen by adding H⁺ to the side deficient in hydrogen.
 - Balance charge by adding electrons.
- Multiply one or both balanced half-equations by appropriate integers in order to have equal number of electrons in the half-equations.
- Add the half-equations together and cancel identical specie.
- Check to ensure that the elements and charges balance.

Example 4

Balance the redox reaction between dichromate (iv) and chloride ions taking place in acidic solution.

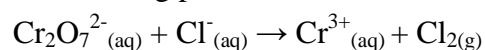

Solution

1. Write down the separate half-equations
 $\text{Cr}_2\text{O}_7^{2-} \rightarrow \text{Cr}^{3+}$ is reduction half-equation
 +6-2 +3
 and
 $\text{Cl}^- \rightarrow \text{Cl}_2$ is oxidation half-equation
 -1 0
2. Balance each half-equation.

For the oxidation reaction, we have

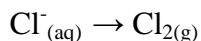

We balance the elements

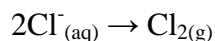

Next we balance charge; two electrons are needed on the right to give a net -2 on both sides.

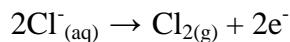

Both elements and charge are balanced.

This is a balanced oxidation half-equation.

For the reduction half-reaction,

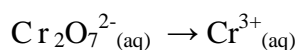

Balance the elements,

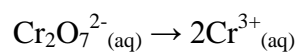

Balance oxygen by adding $7\text{H}_2\text{O}$ to the right side of the equation.



Next balance H by adding 14H^+ to the left

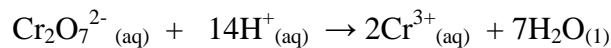

The elements are balanced but we need to balance charge by adding electrons to the left side, so that both sides will have the same net charge.

$$\text{Left} = -2 + 14 : \text{Right} = +6$$

We can balance charge by adding six electrons to the left to give a net charge of $+6$ on both sides.

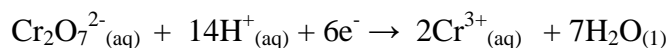

Since the reduction half-reaction shows the gain of six electrons, then we must equalize electrons by multiplying oxidation half-reaction by 3:

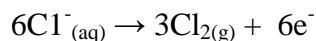

Then, we add the half-reactions,

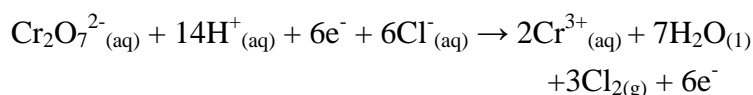

Then, cancel identical species. Here, the identical species are electrons. The final equation is:

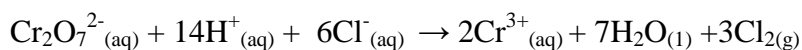

Now check to ensure that the elements and charges balance:

Elements: 2Cr, 7 O, 14H, 6Cl \rightarrow 2Cr 7 O, 14H, 6Cl

Charges: $-2 + 14 - 6 = +6 \rightarrow +6$,

The equation is balanced.

Tests for Oxidizing Agents

An oxidizing agent is an electron acceptor. Iron (II) Chloride and Hydrogen sulphide are often used to identify oxidizing agents. In such reactions, the oxidizing agent accepts electron(s) from the test reagent, which itself is oxidized by the loss of electron(s). If iron (II) Chloride solution, which is pale green in colour is added to an oxidizing agent, it will donate an

electron to the oxidizing agent and form a yellow brown solution of Iron (II) Chloride.

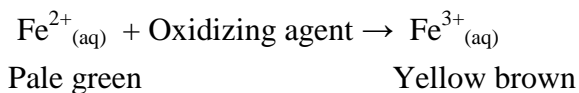

When hydrogen sulphide, H_2S , is passed into a solution of an oxidizing agent, yellow deposits of sulphur are formed. What happens is that, the Sulphide ions, S^{2-} lose (donate) two electrons each to the oxidizing agent, and form atomic Sulphur, which is yellow in colour.

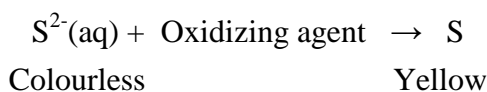

Test for Reducing Agents

A reducing agent is an electron donor. In the process of a reaction it donates electron(s). Potassium tetraoxomanganate (vii) and Potassium heptaoxodichromate (VII) are often used to test for reducing agents. When acidified potassium tetraoxomanganate (VII) solution is added to a reducing agent, its purple colour is discharged. This is because, the purple coloured tetraoxomanganate (VII) ion, MnO_4^- is reduced by accepting electrons from the reducing agent and in the process it forms the colourless Manganese (II) ion, $\text{Mn}^{2+}_{(\text{aq})}$

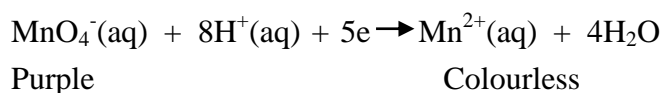

Potassium heptaoxodichromate (vi) is another reagent used in identifying a reducing agent. If a reducing agent is added to

acidified potassium heptaoxodichromate (VI) solution, its orange colour is changed to green. This is because the heptaoxodichromate (VI) ion, $\text{Cr}_2\text{O}_7^{2-}$, that is, orange in colour is reduced by accepting electrons from the reducing agent to give the green coloured chromium (iii) ion, Cr^{3+} .

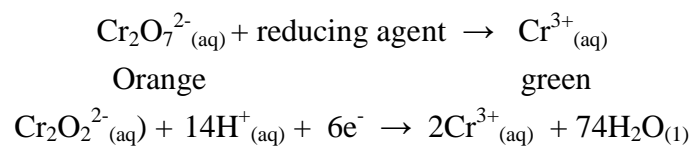

CHAPTER NINE

9.0 Chemical Kinetics

Chemical reaction is an evidence of bond breaking and rearrangement, when substances called reactants are made to undergo chemical changes by means of effective collision of their molecules to give the end products. However, for a chemical reaction to occur, there must be an effective collision between the molecules of the reactants and they must possess energy equal to or greater than the activation energy.

The rates at which reactions occur vary from very rapid to very slow. Chemical kinetics is the study of the speed or the rate of chemical reaction and with elucidation of their mechanism.

The essence of studying chemical kinetics entails giving a clue as to how a reaction takes place and ability to improve chemical syntheses by accelerating desirable reactions while minimizing the effects of undesirable reactions. Shelf-life of a substance is studied by chemical kinetics.

9.1 Collision Theory

Before a chemical reaction can occur, the molecules of the reacting substances must be activated. It is these activated molecules that collide and lead to the reaction. This implies that without activation energy, effective collision cannot take place. Activation energy, E_a is the minimum energy, which the molecules of the reactant must absorb (or possess) before a reaction can take place. For effective collision, the inherent kinetic energy of the molecules must be equal to or greater than their activation energy.

According to Arrhenius, the rate constant, K of a chemical reaction is given as:

$$K = Ae^{-\frac{E_a}{RT}} \dots \dots \dots (1)$$

where,

A = frequency factor = number of effective collision

E_a = activation energy

R = gas constant

T = absolute temperature

Limitations of Collision Theory

- The agreement between experimental rate constant and the value calculated from collision theory is restricted to a comparatively small number of chemical reactions.
- In many gases-phase reactions and in most liquid-phase reactions the rate constant is much less than predicted by the collision theory.

To accommodate this discrepancy, equation was modified to the form:

$$K = PZ. e^{-\frac{E_a}{RT}} \dots \dots \dots (2)$$

where,

P = steric or probability factor

Z = collision frequency

P is the measure of discrepancy between the theoretical rate constant and experimental rate constant. Its value ranges from unity to about 10^{-9} . No significant reason has been attributed to P, but it is being speculated that for some reactions, it is necessary for the reactant molecules to orient themselves in a certain direction before the transition state was formed.

For like molecules, such as

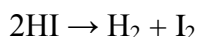

Collision of frequency, Z is expressed as

$$Z_{11} = \frac{\sqrt{2}}{2} \cdot \pi \cdot \sigma^2 \cdot v \cdot (n')^2 \dots \dots \dots (3)$$

where,
 σ = collision diameter of the molecules
 v = velocity of the diameter
 n' = number of molecules per cm^3

But,

$$v = \sqrt{\frac{8RT}{\pi M}} \dots \dots \dots (4)$$

where,
 M = molar mass

Inserting Equation (4) in Equation (3), we have

$$Z_{11} = 2\sigma^2(n')^2 \sqrt{\frac{\pi RT}{M}} \dots \dots \dots (5)$$

Thus,

$$K = 2P\sigma^2(n')^2 \sqrt{\frac{\pi RT}{M}} \cdot e^{-\frac{E_a}{RT}} \dots \dots \dots (6)$$

Also, for two unlike molecules, such as

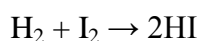

Collision frequency, Z is expressed as

$$Z_{12} = n'_1 n'_2 (\sigma_{12})^2 \cdot \pi \cdot v \dots \dots \dots (7)$$

where,
 n'_1 and n'_2 = number of molecules of the reactants
 σ_{12} = mean collision diameter between the molecules

$$= \frac{\sigma_1 + \sigma_2}{2}$$

v = velocity of the molecules

But,

$$v = \sqrt{\frac{8RT}{\pi\mu}} \dots \dots \dots (8)$$

And

$$\mu = \frac{M_1 M_2}{M_1 + M_2} \dots \dots \dots (9)$$

where,

M_1 and M_2 are the molar masses of the reactants

Inserting Equations (8) and (9) into Equation (7), we have

$$Z_{12} = n'_1 n'_2 (\sigma_{12})^2 \cdot \pi \cdot \sqrt{\frac{8RT(M_1 + M_2)}{\pi \cdot M_1 M_2}} \dots \dots \dots (10)$$

Equation (10) can be written as

$$Z_{12} = n'_1 n'_2 (\sigma_{12})^2 \sqrt{\frac{\pi 8RT(M_1 + M_2)}{M_1 M_2}} \dots \dots \dots (11)$$

Thus,

$$K = P \cdot n'_1 n'_2 (\sigma_{12})^2 \sqrt{\frac{\pi 8RT(M_1 + M_2)}{M_1 M_2}} \cdot e^{-\frac{E_a}{RT}} \dots \dots \dots (12)$$

9.2 Activation Energy

The activation energy of a reaction is the amount of energy needed to start the reaction. It represents the minimum energy needed to form an activated complex during a collision between reactants.

From the concept of activation, reactants are not directly converted to products. The molecules first acquire energy to

form an activated complex, which decomposes into products. This implies that there is an energy barrier between the reactants and products. If it is overcome, then reactants will be converted to products.

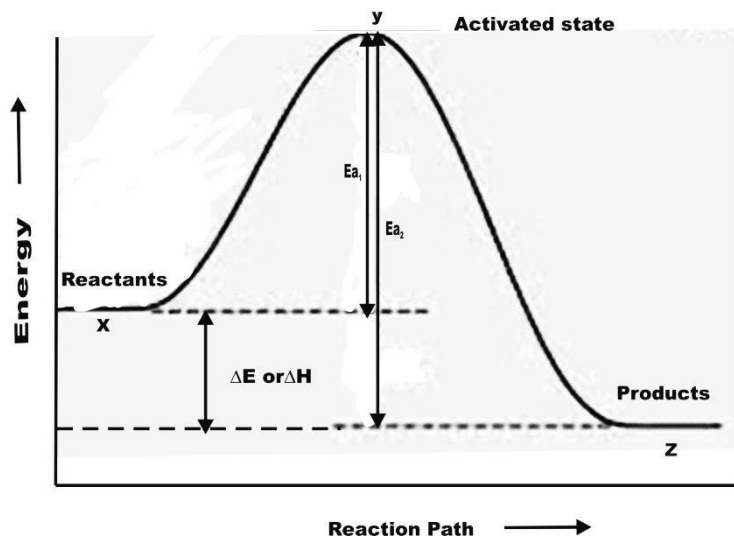

Figure 9.1: Typical activation profile

$$E_{a_1} = E_y - E_x \dots \dots \dots (13)$$

where,

E_y

= energy possessed by the molecules in the activated state

E_x = average energy of the reactant

Also,

$$E_{a_2} = E_y - E_z \dots \dots \dots (14)$$

E_z = average energy of the product

Thus,

$$\Delta E = E_{a_1} - E_{a_2} \dots \dots \dots (15)$$

$$\begin{aligned} \Delta E &= E_y - E_x - (E_y - E_z) \\ \Delta E &= E_y - E_x - E_y + E_z \\ \Delta E &= E_z - E_x \dots \dots \dots (16) \end{aligned}$$

Equation (16) simply implies that activation energy, E_{a_1} must be added to the molecules of the reactants for them to reach the activated state and energy, E_{a_2} must be evolved as the activated molecules decompose to form products.

Activation Energy and Rate Constant

The relationship between activation energy, E_a and rate constant is given by the Arrhenius Equation,

$$K = Ae^{-\frac{E_a}{RT}} \dots \dots \dots (1)$$

where,
 A = frequency factor E_a = activation energy
 R = gas constant
 T = absolute temperature

Taking both sides to \log_e we have

where,
 A = frequency factor = number of effective collision
 E_a = activation energy
 R = gas constant
 T = absolute temperature

$$\log_e K = \log_e \left(Ae^{-\frac{E_a}{RT}} \right) \dots \dots \dots (17)$$

$$\log_e K = \log_e A + \log_e e^{-\frac{E_a}{RT}}$$

$$\log_e K = \log_e A + \left(-\frac{E_a}{RT} \right)$$

$$\log_e K = \log_e A - \frac{E_a}{RT} \dots \dots \dots (18)$$

At $T = T_1$ and $K = K_1$, Equation (18) becomes

$$\log_e K_1 = \log_e A - \frac{E_a}{RT_1} \dots \dots \dots (19)$$

At $T = T_2$ and $K = K_2$, Equation (18) becomes

$$\log_e K_2 = \log_e A - \frac{E_a}{RT_2} \dots \dots \dots (20)$$

Subtracting Equation (19) from Equation (20), we have

$$\log_e K_2 - \log_e K_1 = \log_e A - \frac{E_a}{RT_2} - \left(\log_e A - \frac{E_a}{RT_1} \right)$$

$$\log_e \left(\frac{K_2}{K_1} \right) = \log_e A - \frac{E_a}{RT_2} - \log_e A + \frac{E_a}{RT_1}$$

$$\log_e \left(\frac{K_2}{K_1} \right) = -\frac{E_a}{RT_2} + \frac{E_a}{RT_1}$$

$$\log_e \left(\frac{K_2}{K_1} \right) = \frac{E_a}{RT_1} - \frac{E_a}{RT_2}$$

$$\log_e \left(\frac{K_2}{K_1} \right) = \frac{E_a}{R} \left(\frac{1}{T_1} - \frac{1}{T_2} \right) \dots \dots \dots (21)$$

But, $\log_e x = 2.303 \log_{10} x$

Thus,

$$2.303 \log_{10} \left(\frac{K_2}{K_1} \right) = \frac{E_a}{R} \left(\frac{1}{T_1} - \frac{1}{T_2} \right) \dots \dots \dots (22)$$

$$\log_{10} \left(\frac{K_2}{K_1} \right) = \frac{E_a}{2.303R} \left(\frac{1}{T_1} - \frac{1}{T_2} \right) \dots \dots \dots (23)$$

Example 1

The reaction of hexaquo chromium ion (III) and thiocyanate ion to form a complex ion,

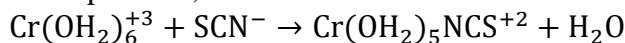

is governed by the rate law,

$$R = K[\text{Cr}(\text{OH}_2)_6^{+3}][\text{SCN}^-]$$

The value of K is 2.00×10^{-6} litre/mole.s at 14°C and 2.2×10^{-5} litre/mole.s at 30°C . What is the value of E_a ? ($R = 1.99$ cal/mol.K).

Solution

Using,

$$\log_{10} \left(\frac{K_2}{K_1} \right) = \frac{E_a}{2.303R} \left(\frac{1}{T_1} - \frac{1}{T_2} \right)$$

where,

$$K_1 = 2.00 \times 10^{-6} \text{ litre/mole.s}$$

$$K_2 = 2.2 \times 10^{-5} \text{ litre/mole.s}$$

$$T_1 = 14^\circ\text{C} = 14 + 273 \text{ K} = 287 \text{ K}$$

$$T_2 = 30^\circ\text{C} = 30 + 273 \text{ K} = 303 \text{ K}$$

$$E_a = ?$$

$$R = R = 1.99 \text{ cal/mol.K}$$

Thus,

$$\log_{10} \left(\frac{2.2 \times 10^{-5}}{2.0 \times 10^{-6}} \right) = \frac{E_a}{2.303 \times 1.99} \left(\frac{1}{287} - \frac{1}{303} \right)$$

$$\log_{10} 11 = \frac{E_a}{4.5830} \left(\frac{303 - 287}{86961} \right)$$

$$1.041 = \frac{E_a}{4.5830} \times \frac{16}{86961}$$

$$E_a = \frac{1.041 \times 4.5830 \times 86961}{16} = 25930.16 \text{ cal/mol}$$

$$E_a = 25.93 \text{ Kcal/mol}$$

9.3 Rate of Chemical Reaction

The term rate is often used to describe the change in quantity that occurs per unit time. The rate of a reaction is, therefore, the change in the concentration of a reacting substance, C, which occurs during a given period of time, dt .

Generally, rate of a reaction, R is given as

$$R = \frac{dC}{dt} \dots \dots \dots (24)$$

$\frac{dC}{dt}$ is negative, if the concentration of the reacting substance decreases with increase in reaction time (i.e. reactants), and it is positive, if the concentration of the reacting substance increases with increase in reaction time (i.e. products).

Not all substances in a chemical equation change their concentration at the same rate due to differences in the stoichiometric coefficients in the balanced equation.

Consider a hypothetical reaction,

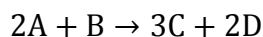

To have the same rate for the chemical reaction, regardless of the substance used to monitor the rate, we express the rate of the above reaction as

$$R = -\frac{d[A]}{2dt} = -\frac{d[B]}{dt} = \frac{d[C]}{3dt} = \frac{d[D]}{2dt} \dots \dots \dots (25)$$

In other words, the rate of a chemical reaction can be defined as the rate at which the concentrations of the participating

chemical species are divided by their stoichiometric coefficients as shown in Equation (25).

9.4 Factors Affecting Rate of Chemical Reaction

The factors affecting the rate of chemical reaction are:

1. Surface area of the reactant
2. Nature of the reactant
3. Concentration
4. Pressure
5. Temperature
6. Catalyst

Effect of Surface Area

If a chemical reaction takes place at a boundary between two phases, surface area will affect the reaction rate. Precisely, surface area is thought of when a solid reactant is in contact with a liquid solution that contains another reactant. Since it is only the molecules at the surface of a solid that are available to react, increasing the surface area results in an increase in the number of molecular collisions that potentially could lead to reaction.

A typical example is the comparison of reaction rates for solid sticks of chalk (CaCO_3) and powdered chalk, when dropped into an acid solution, such as HCl. It is observed that the reaction is faster with powdered chalk as it is evident with effervescence of carbon (IV) oxide, CO_2 .

Effect of Nature of Reactant

Some substances are just naturally more reactive than others. For instance, if magnesium (Mg), zinc (Zn) and copper (Cu) are dropped into a concentrated HCl solution in a separate tube, three very different results are obtained. Magnesium oxidizes easily, reacting vigorously in conc. HCl. Zinc is more difficult to oxidize and it reacts slowly. In the case of copper, hydrogen is not given off at all, indicating no reaction. This is as a result of higher oxidation potential of hydrogen than copper whereas

hydrogen is lower in oxidation potential than both magnesium and zinc.

Effect of Concentration

In general, increase in reactant concentrations increases the reaction rate. This is because the more concentrated the reactants, the greater the number of molecules in any given volume and therefore, the greater the number of molecular collisions. Meanwhile, the greater the number of molecular collisions, the greater the number of effective collisions.

Effect of Pressure

If the substances involved are gases, pressure will affect the rate of reaction. However, for solids and liquids, the effect of pressure is negligible, because solids and liquids are incompressible unlike gases.

By increasing the pressure of a given amount of gas, the same number of gas molecules are being forced to occupy a smaller volume, which eventually leads to more number of successful or effective collision. Therefore, the rate of reaction is increased.

Effect of Temperature

Temperature is a measure of average kinetic energy of reactant molecules, given as

$$\text{Kinetic Energy} = \frac{1}{2}mv^2$$

Fig. 8.1

where,
 m = mass of the substance
 v = velocity of the molecules

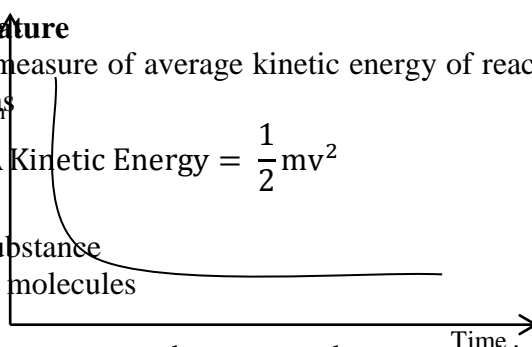

The higher the temperature, the greater the average kinetic energy and the greater the velocity of the molecules. This implies that in a hot system, molecules move faster compared to a cold system, since the molecules will collide more often, if they are moving fast.

It has been noted that the effect of temperature on collision energy is far more important than its effect on collision frequency. By this, we mean that if molecules collide with kinetic energy less than activation energy, effective collision will not take place. But, if kinetic energy is greater than activation energy, by increasing the temperature, effective collision occurs.

Effect of Catalyst

An ideal catalyst has been defined as a chemical substance that increases the speed of a chemical reaction without itself being destroyed or consumed during the reaction. The study of the pathway of catalyst in a chemical reaction is called catalysis.

There are four criteria that a chemical substance must satisfy in order to be classified as a catalyst. These are:

1. Catalysts increase the rate of reaction;
2. Catalysts are not consumed in a chemical reaction. This implies that anything consumed in a reaction is a reactant, and not a catalyst;
3. A small quantity of catalyst should be able to affect the rate of reaction for a large amount of reactant; and
4. Catalysts do not change the equilibrium constant of a reaction.

In addition, catalysts increase the rates of reaction by providing a new mechanism that has smaller activation energy. This is illustrated in Fig. 9.3.

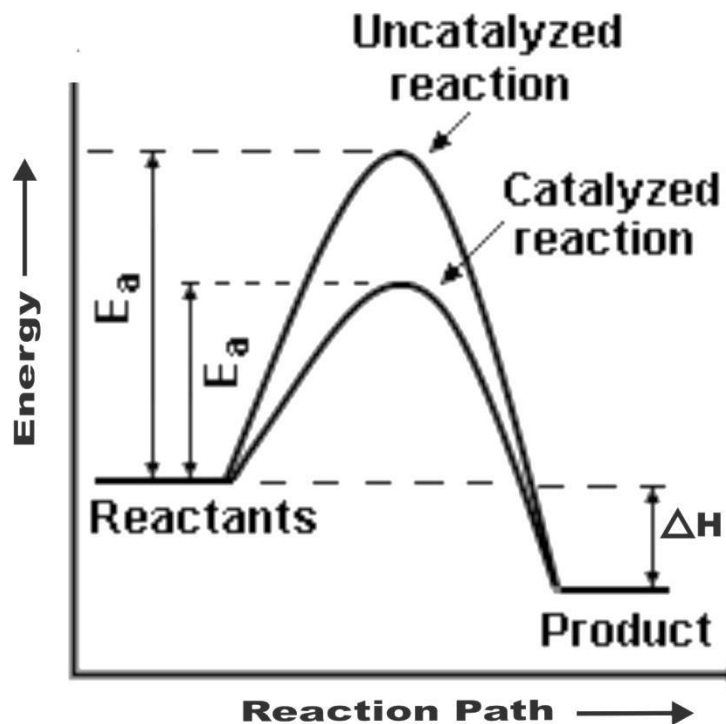

Figure 9.3: Catalyzed and uncatalyzed reaction profiles

Catalysts can be classified into two types: homogeneous and heterogeneous. Homogeneous catalysts are those which exist in the same phase (gas or liquid) as the reactants, while heterogeneous catalysts are not in the same phase as the reactants. Typically, heterogeneous catalysis involves the use of solid catalysts placed in a liquid reaction mixture. Acid catalysis, organometallic catalysis, and enzymatic catalysis are examples of homogeneous catalysis.

Most often, homogeneous catalysis involves the introduction of an aqueous phase catalyst into an aqueous solution of reactants. In such cases, acids and bases are often very effective catalysts, as they can speed up reactions by affecting bond polarization.

An advantage of homogeneous catalysis is that the catalyst mixes into the reaction mixture, allowing a very high degree of interaction between catalyst and reactant molecules. However, unlike with heterogeneous catalysis, the homogeneous catalyst is often irrecoverable after the reaction has run to completion. Homogeneous catalysts are used in variety of industrial applications, as they allow for an increase in reaction rate without an increase in temperature.

9.5 Rate Equation or Rate Law

Consider a reaction with a single reactant,



The rate equation is given as

$$R \propto [A]^x$$

$$R = K[A]^x = -\frac{d[A]}{dt} \dots \dots \dots (26)$$

where,

R = rate of reaction

K = rate constant

[A] = concentration of A

x = order of reaction, which is independent of the stoichiometry of the balanced equation. For precision, it is determined experimentally. A typical concentration-time graph can be obtained by plotting the decreasing concentration of A with increasing reaction time (Fig. 9.2).

Note: The negative sign in Equation (26) does not imply that concentration value of A is negative, but indicates that it decreases with increase in reaction time.

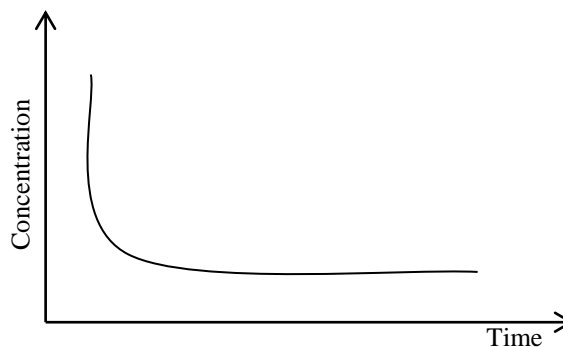
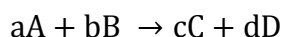

Figure 9.2: Concentration-time graph

9.6 Order of Reaction

The order of reaction is defined as the number of atoms or molecules whose concentrations determine the rate of reaction. In other words, the order of a reaction is defined as the sum of the powers of the concentration terms in the rate equation. Consider a hypothetical reaction,



The rate law is expressed as,

$$R = K[A]^x[B]^y \dots \dots \dots (27)$$

where, x and y are the orders of reactants A and B respectively. The values of x and y are independent of the stoichiometric coefficients, a and b of reactants A and B in the balanced chemical equation. The sum of x and y is equal to the overall order of the reaction.

For clarity, let us consider the following reactions:

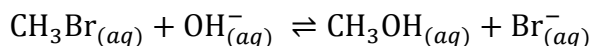

$$R = K[\text{CH}_3\text{Br}][\text{OH}^-]$$

A similar reaction with slightly different starting materials gives similar products, but different rate equation:

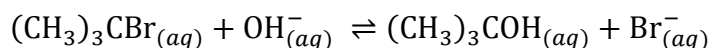

$$R = K[(\text{CH}_3)_3\text{CBr}]$$

This concludes the fact that the rate law for a reaction cannot be predicted from the stoichiometry of the reaction; it must be done experimentally.

Better still, the explanation above can be stressed in two ways:

1. Sometimes, the rate law is consistent with what we expect from the stoichiometric reaction.

For instance,

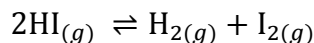

$$R = K[\text{HI}]^2$$

2. Often, it is not.

For instance,

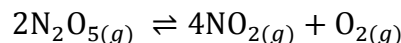

$$R = K[\text{N}_2\text{O}_5]$$

The values of x and y can be whole number, fractional or zero.

9.7 First-Order Reactions

Consider a hypothetical reaction,

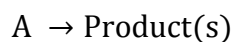

$$R = -\frac{d[\text{A}]}{dt} = K[\text{A}] \dots \dots \dots (28)$$

If a = initial concentration of A and x = decreased concentration of A at time, t , Equation (28) becomes

$$-\frac{d(a-x)}{dt} = K(a-x)$$

$$-\frac{da}{dt} + \frac{dx}{dt} = K(a - x)$$

But, $\frac{da}{dt} = 0$, because a is a constant

Hence,

$$\frac{dx}{dt} = K(a - x)$$

$$\frac{dx}{(a - x)} = K dt \dots \dots \dots (29)$$

Integrating Equation (29) between the limits $x = 0$, when $t = 0$ and $x = x$, when $t = t$

$$K \int_{t=0}^{t=t} dt = \int_{x=0}^{x=x} \frac{dx}{(a - x)}$$

$$K[t]_0^t = [-\ln(a - x)]_0^x$$

$$K(t - 0) = -\ln(a - x) - (-\ln a)$$

$$Kt = -\ln(a - x) + \ln a$$

$$Kt = \ln a - \ln(a - x)$$

$$Kt = \ln \left(\frac{a}{a - x} \right) \dots \dots \dots (30)$$

Since $\log_e x = \ln x = 2.303 \log_{10} x$

Hence,

$$Kt = 2.303 \log_{10} \left(\frac{a}{a - x} \right) \dots \dots \dots (31)$$

Or

$$K = \frac{2.303}{t} \log_{10} \left(\frac{a}{a - x} \right) \dots \dots \dots (32)$$

Or

$$t = \frac{2.303}{K} \log_{10} \left(\frac{a}{a-x} \right) \dots \dots \dots (33)$$

Determination of Half-Life of First-Order Reaction

Recall Equation (33),

$$t = \frac{2.303}{K} \log_{10} \left(\frac{a}{a-x} \right) \dots \dots \dots (33)$$

Half-life, $t_{1/2}$ of the reaction is simply defined as the time take to reduce a (i.e. initial concentration of the reactant) to half its concentration value.

This implies that at $t_{1/2}, x = \frac{a}{2}$

Hence,

$$t_{1/2} = \frac{2.303}{K} \log_{10} \left(\frac{a}{a - a/2} \right)$$

$$t_{1/2} = \frac{2.303}{K} \log_{10} \left(\frac{a}{a/2} \right)$$

$$t_{1/2} = \frac{2.303}{K} \log_{10} 2$$

$$t_{1/2} = \frac{2.303 \times 0.3010}{K}$$

$$t_{1/2} = \frac{0.693}{K} \dots \dots \dots (34)$$

Graphical Deduction of Rate Constant from First-Order Reactions

The value of K can be deduced graphically as follows:
 Recall Equation (31),

$$Kt = 2.303 \log_{10} \left(\frac{a}{a-x} \right) \dots \dots \dots (31)$$

$$\frac{Kt}{2.303} = \log_{10} \left(\frac{a}{a-x} \right)$$

$$\frac{Kt}{2.303} = \log_{10} a - \log_{10}(a-x)$$

$$\log_{10}(a-x) = \log_{10} a - \frac{Kt}{2.303}$$

$$\log_{10}(a-x) = \log_{10} a + \left(-\frac{K}{2.303} \right) \cdot t \dots \dots \dots (35)$$

Equation (35) looks like straight line equation, $y = mx + c$

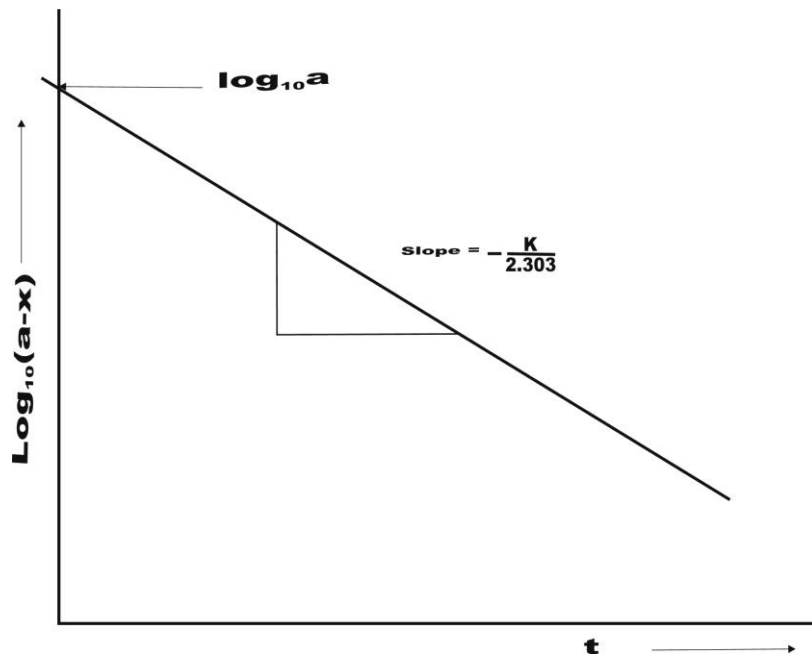

Figure 9.4: Graphical deduction of rate constant

From Fig. 9.4,

$$K = -2.303 \times \text{slope}$$

9.8 Second-Order Reactions

Consider a hypothetical reaction,

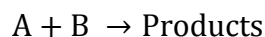

$$-\frac{d[A]}{dt} = -\frac{d[B]}{dt} = K[A][B] \dots \dots \dots (36)$$

Thus,

$$-\frac{d[A]}{dt} = K[A][B]$$

If a and b are the initial concentrations of A and B respectively and x is the concentration of each that has been consumed at time, t , then we have

$$-\frac{d(a-x)}{dt} = K(a-x)(b-x)$$

$$-\frac{da}{dt} + \frac{dx}{dt} = K(a-x)(b-x)$$

Since a is a constant, $\frac{da}{dt} = 0$

$$\frac{dx}{dt} = K(a-x)(b-x)$$

$$\frac{dx}{(a-x)(b-x)} = Kdt$$

$$Kdt = \frac{dx}{(a-x)(b-x)}$$

$$Kdt = dx \cdot \left(\frac{1}{(a-x)(b-x)} \right) \dots \dots \dots (37)$$

$\frac{1}{(a-x)(b-x)}$ can be resolved into fractions as follows:

$$\frac{1}{(a-x)(b-x)} \equiv \frac{A}{(a-x)} + \frac{B}{(b-x)}$$

$$\frac{1}{(a-x)(b-x)} \equiv \frac{A(b-x) + B(a-x)}{(a-x)(b-x)}$$

$$1 \equiv A(b-x) + B(a-x)$$

Put $x = a$

$$1 = A(b-a) + B(a-a)$$

$$1 = A(b-a) + B \times 0$$

$$1 = A(b-a)$$

$$A = \frac{1}{(b-a)}$$

Put $x = b$

$$1 = A(b-b) + B(a-b)$$

$$1 = A \times 0 + B(a-b)$$

$$1 = B(a-b)$$

$$B = \frac{1}{(a-b)}$$

Thus,

$$\frac{1}{(a-x)(b-x)} = \frac{1}{(a-x)(b-a)} + \frac{1}{(b-x)(a-b)}$$

$$\frac{1}{(a-x)(b-x)} = -\frac{1}{(a-x)(a-b)} + \frac{1}{(b-x)(a-b)}$$

$$\frac{1}{(a-x)(b-x)} = \frac{1}{(b-x)(a-b)} - \frac{1}{(a-x)(a-b)}$$

$$\frac{1}{(a-x)(b-x)} = \frac{1}{(a-b)} \left[\frac{1}{(a-b)} - \frac{1}{(a-x)} \right]$$

Thus, Equation (37) becomes

$$Kdt = \frac{1}{(a-b)} \left[\frac{1}{(a-b)} - \frac{1}{(a-x)} \right] dx \dots \dots \dots (38)$$

Integrating Equation (38) between the limits $x = 0$ at $t = 0$ and $x = x$ at $t = t$

$$K \int_{t=0}^{t=t} dt = \frac{1}{(a-b)} \int_{x=0}^{x=x} \left[\frac{1}{(a-b)} - \frac{1}{(a-x)} \right] dx$$

$$K[t]_0^t = \frac{1}{(a-b)} [-\ln(b-x) - (-\ln(a-x))]_0^x$$

$$K(t-0) = \frac{1}{(a-b)} [-\ln(b-x) + \ln(a-x)]_0^x$$

$$Kt = \frac{1}{(a-b)} [-\ln(b-x) + \ln b + \ln(a-x) - \ln a]$$

$$Kt = \frac{1}{(a - b)} [\ln(a - x) - \ln(b - x) + \ln b - \ln a]$$

$$Kt = \frac{1}{(a - b)} \ln \left[\frac{b(a - x)}{a(b - x)} \right] \dots \dots \dots (39)$$

But, $\ln x = 2.303 \log_{10} x$
Hence, Equation (39) becomes

$$Kt = \frac{2.303}{(a - b)} \log_{10} \left[\frac{b(a - x)}{a(b - x)} \right] \dots \dots \dots (40)$$

Or

$$K = \frac{2.303}{t(a - b)} \log_{10} \left[\frac{b(a - x)}{a(b - x)} \right] \dots \dots \dots (41)$$

$$t = \frac{2.303}{K(a - b)} \log_{10} \left[\frac{b(a - x)}{a(b - x)} \right] \dots \dots \dots (42)$$

9.9 Zero-Order Reactions

There are reactions in which the concentrations of the reactants remain constant during the course of the reaction, and therefore, the rate of reaction is independent of the concentrations of such reacting species.

Consider a reaction,



$$-\frac{d[A]}{dt} = \frac{d[\text{Product}]}{dt} = K_0 \dots \dots \dots (43)$$

If the change in concentration of the product at time, t is x, then we have

$$\frac{dx}{dt} = K_o$$

$$K_o dt = dx \dots \dots \dots (44)$$

Integrating Equation (44) between limits $x = 0$ at $t = 0$ and $x = x$ at $t = t$

$$K_o \int_{t=0}^{t=t} dt = \int_{x=0}^{x=x} dx$$

$$K_o [t]_0^t = [x]_0^x$$

$$K_o(t - 0) = (x - 0)$$

$$K_o t = x \dots \dots \dots (45)$$

Or

$$K_o = \frac{1}{t} \cdot x \dots \dots \dots (46)$$

Or

$$t = \frac{1}{K_o} \cdot x \dots \dots \dots (47)$$

Equation (47) shows that the concentration of the product increases with increase in reaction time, t .

Instances of zero-order reactions are:

- Elimination of ethyl alcohol in the body by the liver. The rate of alcohol removal is constant, because the number of available catalyst molecules present in the liver is constant.
- Decomposition of gaseous NH_3 into H_2 and N_2 on a hot platinum surface.

Note

1. In first-order reactions, doubling the concentration of the reactant increases the rate by a factor of 2;
2. In second-order reactions, doubling the concentration of the reactant increases the rate by a factor of 4; and
3. In zero-order reactions, doubling the concentration has no effect on the rate.

Example 2

The data below are for the reaction of NO with Cl₂ to form NOCl at 295 K.

[Cl ₂] (M)	[NO] (M)	Initial Rate (mol/L.s)
0.050	0.050	1.0 x 10 ⁻³
0.150	0.050	3.0 x 10 ⁻³
0.050	0.150	9.0 x 10 ⁻³

1. (i) What is the order with respect to NO?
(ii) What is the order with respect to Cl₂?
2. Write the rate expression
3. Calculate K, the rate constant
4. Determine the reaction rate, when the concentrations of Cl₂ = 0.20 M and that of NO = 0.40 M

Solution

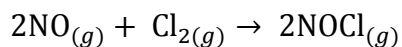

$$R = K[\text{NO}]^x[\text{Cl}_2]^y$$

1. (i) Using

$$\frac{R_2}{R_1} = \left(\frac{[\text{NO}]_2}{[\text{NO}]_1} \right)^x$$

where,

x = order of reaction with respect to NO

$R_2 = 9.0 \times 10^{-3}$ mol/L.s

$$\begin{aligned}R_1 &= 1.0 \times 10^{-3} \text{ mol/L.s} \\ [\text{NO}]_2 &= 0.150 \text{ M} \\ [\text{NO}]_1 &= 0.050 \text{ M}\end{aligned}$$

Hence,

$$\frac{9.0 \times 10^{-3}}{1.0 \times 10^{-3}} = \left(\frac{0.150}{0.050}\right)^x$$

$$9 = 3^x$$

$$3^x = 9$$

$$3^x = 3^2$$

$$x = 2$$

Therefore,

The overall order of reaction with respect to NO = 2

(ii) Using,

$$\frac{R_2}{R_1} = \left(\frac{[\text{Cl}_2]_2}{[\text{Cl}_2]_1}\right)^y$$

where,

y = order of reaction with respect to NO

$$R_2 = 3.0 \times 10^{-3} \text{ mol/L.s}$$

$$R_1 = 1.0 \times 10^{-3} \text{ mol/L.s}$$

$$[\text{Cl}_2]_2 = 0.150 \text{ M}$$

$$[\text{Cl}_2]_1 = 0.050 \text{ M}$$

Hence,

$$\frac{3.0 \times 10^{-3}}{1.0 \times 10^{-3}} = \left(\frac{0.150}{0.050}\right)^y$$

$$3 = 3^y$$

$$3^y = 3$$

$$3^y = 3$$

$$y = 1$$

Therefore,

The overall order of reaction with respect to $\text{Cl}_2 = 1$

2. $R = K[\text{NO}]^2[\text{Cl}_2]$

3. $R = K[\text{NO}]^2[\text{Cl}_2]$

When $R = 1.0 \times 10^{-3}$, $[\text{NO}] = 0.050 \text{ M}$, $[\text{Cl}_2] = 0.050 \text{ M}$ and $K = ?$

$$1.0 \times 10^{-3} = K(0.05)^2(0.05)$$

$$1.0 \times 10^{-3} = K \times 1.25 \times 10^{-4}$$

$$K = \frac{1.0 \times 10^{-3}}{1.25 \times 10^{-4}}$$

$$K = 8.0 \text{ mol}^2/\text{L}^2 \cdot \text{s}$$

4. $R = K[\text{NO}]^2[\text{Cl}_2]$

When $K = 8.0 \text{ mol}^2/\text{L}^2 \cdot \text{s}$, $[\text{NO}] = 0.40 \text{ M}$ and $[\text{Cl}_2] = 0.20 \text{ M}$, we have

$$R = 8.0 \times (0.40)^2 \times (0.20)$$

$$R = 8.0 \times 0.032 \text{ mol/L} \cdot \text{s}$$

$$R = 0.256 \text{ mol/L} \cdot \text{s}$$

$$R = 2.56 \times 10^{-1} \text{ mol/L} \cdot \text{s}$$

9.10 Chain Reaction

Chain reaction is a form of reaction that takes place by a series of successive processes or repeating steps, involving the formation of free atoms and radicals. Once started, chain reactions continue until the reactants are exhausted. Fire and explosions are some of the phenomena associated with chain reactions.

The steps involved in chain reactions are:

1. Initiation step
2. Propagation step
3. Inhibition step
4. Termination step

To explain these steps, the chlorination of ethane, which is a chain reaction can be used.

Initiation Step

At room temperature, there is no detectable reaction between Cl_2 and C_2H_6 until the mixture is exposed to light. This results in the production of very reactive intermediates called free radicals (or chain carriers). The free radicals for Cl_2 are written as:

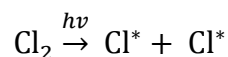

Propagation Step

This entails the consumption of one radical, which is accompanied with the generation of another. Basically, the number of free radical consumed is equal to the number of free radicals generated.

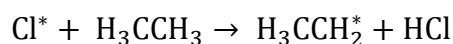
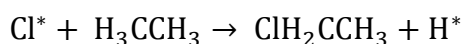



Thus, the chain reactions continue, releasing heat and light. The heat and light causes more radicals to be generated.

There are occasions whereby free radicals generated are more than the ones consumed. This results in chain branching reaction, behind explosions. An example of branching reactions is the reaction between hydrogen and oxygen.

The following may take place

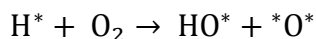

where, $\text{}^*\text{O}^*$ is a di-radical because O atom has electronic configuration of $1s^2 2s^2 2p_x^2 2p_y^1 2p_z^1$.

The di-radical may proceed as follows:

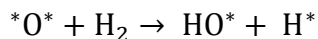

Thus, branching reactions contribute to the rapid explosion of H-O mixtures, especially if the mixtures are in the right proportion.

Inhibition Step

This is the step that prevents the formation of products as shown below:

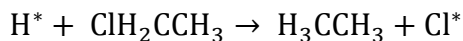
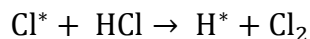
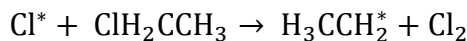

Besides, a reactive substance called radical scavenger, A^* may reduce the chain carrier and therefore, inhibits the chain reactions



In food industry, radical scavengers are added to prevent spoilage due to oxidation.

Termination Step

In this step, free radicals are consumed due to the exhaustion of reactants. Thus, free radicals combine with one another to give stable molecules.

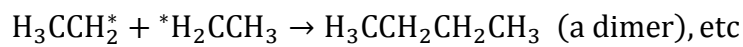
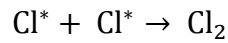

9.11 Rate of Chain Reactions

To express the rate of chemical reactions, decomposition of ethane can be used

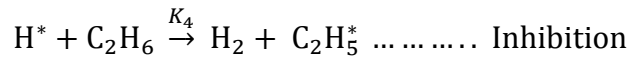
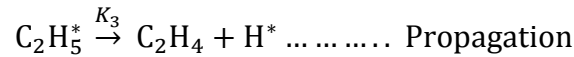
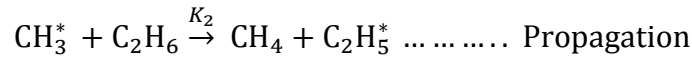
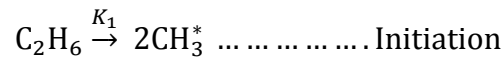

$$-\frac{d[\text{C}_2\text{H}_6]}{dt} = K_1[\text{C}_2\text{H}_6] + K_2[\text{CH}_3^*][\text{C}_2\text{H}_6] + K_4[\text{H}^*][\text{C}_2\text{H}_6] \dots (48)$$

Based on steady-state principle,

$$\frac{d[\text{CH}_3^*]}{dt} = 2K_1[\text{C}_2\text{H}_6] - K_2[\text{CH}_3^*][\text{C}_2\text{H}_6] = 0 \dots (49)$$

$$2K_1[\text{C}_2\text{H}_6] = K_2[\text{CH}_3^*][\text{C}_2\text{H}_6]$$

$$[\text{CH}_3^*] = \frac{2K_1[\text{C}_2\text{H}_6]}{K_2[\text{C}_2\text{H}_6]}$$

$$[\text{CH}_3^*] = \frac{2K_1}{K_2} \dots \dots \dots (50)$$

Likewise,

$$\frac{d[\text{H}^*]}{dt} = K_3[\text{C}_2\text{H}_5^*] - K_4[\text{H}^*][\text{C}_2\text{H}_6] = 0 \dots \dots (51)$$

$$K_3[\text{C}_2\text{H}_5^*] = K_4[\text{H}^*][\text{C}_2\text{H}_6]$$

$$[\text{H}^*] = \frac{K_3[\text{C}_2\text{H}_5^*]}{K_4[\text{C}_2\text{H}_6]} \dots \dots \dots (52)$$

Also,

$$\begin{aligned} \frac{d[\text{C}_2\text{H}_5^*]}{dt} = & K_2[\text{CH}_3^*][\text{C}_2\text{H}_6] - K_3[\text{C}_2\text{H}_5^*] + K_4[\text{H}^*][\text{C}_2\text{H}_6] \\ & - K_5[\text{C}_2\text{H}_5^*]^2 = 0 \dots (53) \end{aligned}$$

Inserting Equations (50) and (52) into Equation (53), we have

$$\begin{aligned} \frac{d[\text{C}_2\text{H}_5^*]}{dt} = & K_2 \times \frac{2K_1}{K_2} \times [\text{C}_2\text{H}_6] - K_3[\text{C}_2\text{H}_5^*] + K_4 \\ & \times \frac{K_3[\text{C}_2\text{H}_5^*]}{K_4[\text{C}_2\text{H}_6]} \times [\text{C}_2\text{H}_6] - K_5[\text{C}_2\text{H}_5^*]^2 = 0 \end{aligned}$$

$$\frac{d[C_2H_5^*]}{dt} = 2K_1[C_2H_6] - K_3[C_2H_5^*] + K_3[C_2H_5^*] - K_5[C_2H_5^*]^2 = 0$$

$$\frac{d[C_2H_5^*]}{dt} = 2K_1[C_2H_6] - K_5[C_2H_5^*]^2 = 0$$

$$K_5[C_2H_5^*]^2 = 2K_1[C_2H_6]$$

$$[C_2H_5^*] = \left(\frac{2K_1}{K_5}\right)^{\frac{1}{2}} [C_2H_6]^{\frac{1}{2}} \dots \dots \dots (54)$$

Inserting Equation (54) into Equation (52), we have

$$[H^*] = \frac{K_3}{K_4[C_2H_6]} \times \left(\frac{2K_1}{K_5}\right)^{\frac{1}{2}} [C_2H_6]^{\frac{1}{2}}$$

which can be re-written as

$$[H^*] = \frac{K_3}{K_4} \times \left(\frac{2K_1}{K_5}\right)^{\frac{1}{2}} \frac{[C_2H_6]^{\frac{1}{2}}}{[C_2H_6]} \dots \dots \dots (55)$$

Inserting Equations (50) and (55) into Equation (48), we have

$$-\frac{d[C_2H_6]}{dt} = K_1[C_2H_6] + K_2 \times \frac{2K_1}{K_2} [C_2H_6] + K_4 \frac{K_3}{K_4} \times \left(\frac{2K_1}{K_5}\right)^{\frac{1}{2}} \frac{[C_2H_6]^{\frac{1}{2}}}{[C_2H_6]} [C_2H_6]$$

$$-\frac{d[C_2H_6]}{dt} = K_1[C_2H_6] + 2K_1[C_2H_6] + K_3 \times \left(\frac{2K_1}{K_5}\right)^{\frac{1}{2}} [C_2H_6]^{\frac{1}{2}}$$

$$-\frac{d[\text{C}_2\text{H}_6]}{dt} = 3K_1[\text{C}_2\text{H}_6] + K_3 \times \left(\frac{2K_1}{K_5}\right)^{\frac{1}{2}} [\text{C}_2\text{H}_6]^{\frac{1}{2}} \dots \dots \dots (56)$$

9.12 Applications of Chain Reactions

Applications of chain reactions include:

1. Explosions and fire
2. Polymerization
3. Food spoilage
4. Nuclear reactors

CHAPTER TEN

10.0 Phase Equilibria

A phase is a homogeneous, physically distinct and mechanically separable part of a system. Gibbs described a phase as being "uniform throughout, not only in chemical composition, but also in physical state". Although a phase must be homogeneous, it need not be continuous. Thus a single phase may exist as separate crystals or drops. Systems that consist of more than one phase are said to be heterogeneous with the individual phases separated by phase boundaries. The number of phases present in a system depends upon the chemical nature of the constituents and variables such as composition, pressure or temperature.

Single-component systems may exist as one or more phases. An equilibrium sample of ice, liquid water and water vapour consists of three different phases. The properties and composition of each of the phases are homogenous, but the solid, liquid and gas may be mechanically separated. A mixture of crystals of rhombic and monoclinic sulphur consists of two phases, as the mixture may easily be separated into crystals of the two different allotropes.

Multi-component systems may also exist as one or more phases. However, mixtures of gases only ever form a single phase; gases are always miscible and cannot, therefore be mechanically separated. Some combinations of liquids are also miscible so that the resulting mixture cannot be mechanically separated into its individual constituents. For example, a mixture of liquid toluene and liquid butanol forms a homogeneous single-phase solution at all compositions. Other combinations of liquids are not, however, miscible and instead tend to form separate layers, each of forms a different phase. At room temperature, most mixtures of oil and water separate into two phases.

10.1 The Phase Rule

The phase rule allows us to predict the number of stable phases that may exist in equilibrium for a particular system.

Gibb's phase rule is given as:

$$F = C + 2 - P \dots\dots(1)$$

where,

F = the number of degrees of freedom or the number of independent variables, C = the number of components in a system in equilibrium and P = the number of phases

Constituents and Components

It is not always necessary to specify the amount of every constituent in order to define the chemical composition of a system. A component is defined as a chemically independent constituent of a system. The number of components, C, is the smallest number of independently variable constituents needed to express the composition of each phase. It is the minimum number of substances that would be required in order to make up the equilibrium mixture and may be considered as the total number of constituents N minus the total number of chemical constraints on the complete system and within each phase R.

$$C = N - R \dots\dots(2)$$

Independent chemical reactions act as constraints on the composition of the system, and so contribute to the value of R. Other conditions imposed by the chemical stoichiometry or by the need to maintain electroneutrality should also be counted as constraints. When considering phase equilibria, it is necessary to determine only the number and not the identity of the independent components.

Example 1

A gaseous mixture of CH₄, C₂H₆, C₃H₈ and H₂ consists of four constituents. However, the amounts of these substances are related by two independent chemical equations

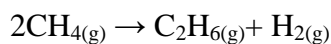

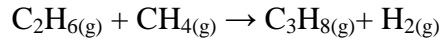

which may be considered as constraints on the system. We could write other chemical equations but these would not be independent of the first two. For example, the equation



is actually just the sum of the first two independent relationships. Thus there must be only two independent components since

$$C = N - R = 4 - 2 = 2$$

Example 2

For the reduction of nickel oxide, NiO,

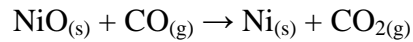

there are four constituents. There are now two constraints on the composition of the phases of the system, the first as a result of the overall stoichiometry of the chemical equation, and the second because the amounts of CO and CO₂ in the gas phase are related. Therefore, only

$$C = N - R = 4 - 2 = 2$$

independent components are necessary to specify the composition of each phase. If, however, additional CO was artificially added to the system, the constraint imposed by the balance of CO and CO₂ in the gas phase would be lost and the composition of each phase could instead only be specified by

$$C = N - R = 4 - 1 = 3$$

independent components.

Degrees of Freedom

In general, we normally need to state the values of only three variables, usually taken as composition and two of pressure, volume and temperature in order to define the state of a system. The variance, or number of degrees of freedom of a system, F is the number of such variables that may be varied independently without changing the number of phases present at equilibrium.

Systems for which $F = 0$ have no degrees of freedom and are said to be invariant. Changing the value of any of the properties that define the state of an invariant system will result in a change in the number of phases present.

Systems with one degree of freedom, $F = 1$, are univariant. For a univariant system, the value of one property may be adjusted without changing the number of phases. However, the values of all other properties then become fixed. For example, if the temperature of a univariant system is adjusted, then the values of the pressure, volume and composition must change in a particular way if the number of phases present is to remain the same.

Systems with two degrees of freedom, $F = 2$, are bivariant. For these systems, the values of two properties may be adjusted independently without a change in the number of phases present. A bivariant system of different phases may therefore remain at equilibrium over a range of values of temperature and of pressure.

10.2 Phase Diagrams

A phase diagram shows the phases that are present at any given temperature and pressure. In the cases, the phases will simply be the solid, liquid or vapour (gas) states of a pure substance.

Types of Phase Diagrams

P-T Diagram

If the phase diagram is plotted between temperature and pressure, the diagram is called P -T diagram. P -T diagram is used for one component system.

T-C Diagram

If the phase diagram is plotted between temperature and composition, the diagram is called T-C diagram. T-C diagram is used for two component system

Uses of Phase Diagram

1. Predicting whether an eutectic alloy (or) a solid solution is formed on cooling a homogeneous liquid containing mixture of two metals.
2. Understanding the properties of materials in the heterogeneous equilibrium system.
3. Studying of low melting eutectic alloys, used in soldering.

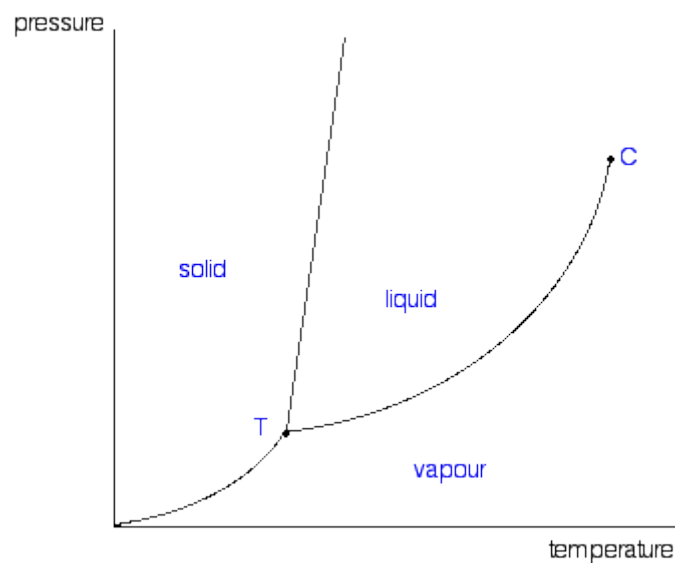

Figure 10.1: Phase diagram for a typical pure substance

The point labelled C in the phase diagram is known as the critical point. The temperature and pressure corresponding to this are known as the critical temperature and critical pressure. If you increase the pressure on a gas (vapour) at a temperature lower than the critical temperature, you will

eventually cross the liquid-vapour equilibrium line and the vapour will condense to give a liquid.

The critical temperature obviously varies from substance to substance and depends on the strength of the attractions between the particles. The stronger the intermolecular attractions, the higher the critical temperature.

The point T on the diagram is called the triple point. The three lines which meet at that point, they represent conditions of solid-liquid equilibrium, liquid-vapour equilibrium and solid-vapour equilibrium. Where all three lines meet, you must have a unique combination of temperature and pressure where all three phases are in equilibrium together.

10.3 The One-Component Phase Diagram

The Phase Diagram for Water System

Water can exist in three different phases namely: ice (solid), water (liquid) and steam (water vapour). The features of water system phase diagram can be used to deduce the degree of freedom of the system (Fig. 10.2).

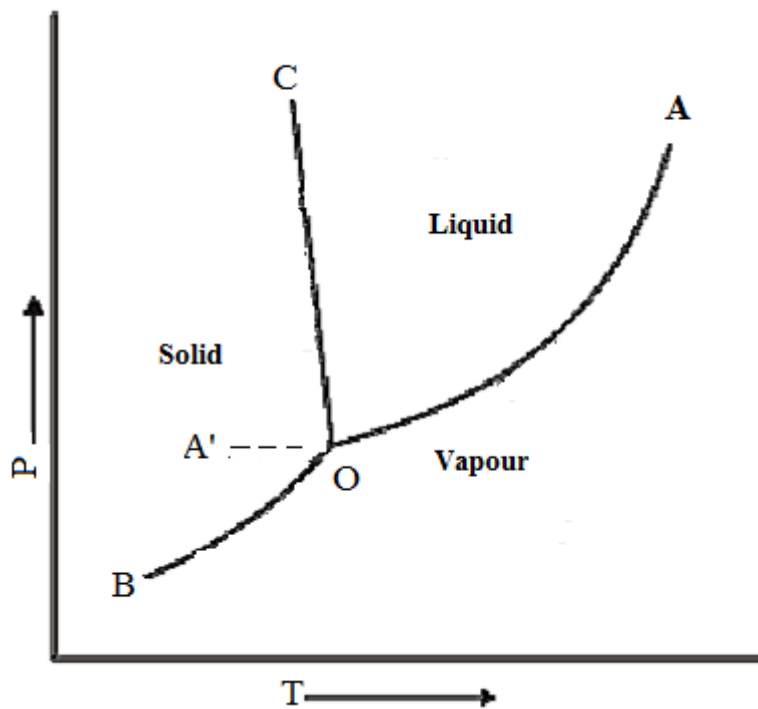

Figure 10.2: Phase diagram of water system

Table 10.1: Description of phase diagram of water system

S/N	Point	Process	Phase in Equilibrium	Degree of Freedom
1	Curve OB	Sublimation curve	Solid \rightleftharpoons Vapour	1
2	Curve OA	Vaporization curve	Liquid \rightleftharpoons Vapour	1
3	Curve OC	Fusion curve	Solid \rightleftharpoons Liquid	1
4	Area left of BOC		Solid	2
5	Area AOC		Liquid	2
6	Area below AOB		Vapour	2
7	Point O (0.0075 °C, 4.6mmHg)		Triple point, Solid \rightleftharpoons Liquid \rightleftharpoons Vapour	0
8	Point A (374 °C,		Critical temperature,	

	217.5 atm)		critical pressure	
9	Curve OA'		Metastable equilibrium Liquid \rightleftharpoons vapour	1

Phase Diagram for Carbon (IV) Oxide System

The system of CO₂ (Fig. 10.3) is very similar to the water system except that the solid – liquid line OC slopes to the right, away from the pressure axis. This indicates that the melting point of solid carbon dioxide rises as the pressure increases.

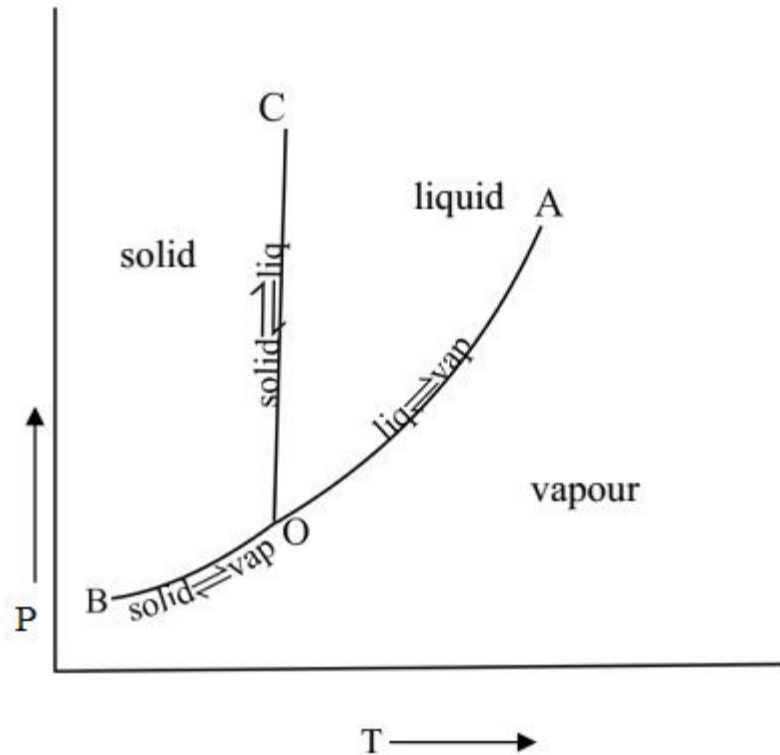

Figure 10.3: Phase diagram of carbon (IV) oxide system

The triple point, O (Fig. 10.3) occurs at -56.4°C and a pressure of about 5 atm. We must note, that as the triple point lies above 1 atm, the liquid phase cannot exist at normal atmospheric pressure whatever be the temperature. Solid carbon dioxide hence sublimates when kept in the open (referred to as “dry ice”).

It is necessary to apply a pressure of about 5 atm or higher to obtain liquid carbon dioxide. Commercial cylinders of CO₂ generally contain liquid and gas in equilibrium, the pressure in the cylinder is about 67 atm if the temperature is 25 °C. When this gas 21 comes out through a fine nozzle, it cools and condenses into a finely divided snow-like solid as the outside pressure is only 1 atm.

Super critical carbon (IV) oxide is obtained by heating compressed carbon (IV) oxide to temperatures above its critical temperature. The critical constants of CO₂ are: T_c = 304.1 K and P_c = 73.8 bar, which are not far from ambient conditions. It is inexpensive and easily available in large quantities. It is nontoxic, nonflammable and inert to most materials. It has good dissolving properties and hence used as a super critical solvent. It is thus an ideal eco-friendly substitute for hazardous and toxic solvents.

It is used for extracting flavours, decaffeination of coffee and tea, recrystallization of pharmaceuticals etc. It is also used in supercritical fluid chromatography, a form of chromatography in which the supercritical fluid is used as the mobile phase. This technique can be used to separate lipids and phospholipids and to separate fuel oil into alkanes, alkenes and arenes.

Table 10.2: Description of phase diagram of carbon (IV) oxide system

S/N	Point	Process	Phase in Equilibrium	Degree of Freedom
1	BO	Sublimation curve	Solid \rightleftharpoons Vapour	1
2	OA	Vaporization curve	Liquid \rightleftharpoons Vapour	1
3	OC	Fusion curve	Solid \rightleftharpoons Liquid	1
4	Area left of BOC		Solid	2
5	Area AOC		Liquid	2
6	Area below AOB		Vapour	2
7	Point O (-56.4°C, ~ 5		Triple point, Solid \rightleftharpoons Liquid \rightleftharpoons Vapour	0

	mmHg)		
8	Point A (31.1 °C, 73 atm)		Critical temperature, critical pressure

The Phase Diagram for Sulphur System

There are two crystalline forms of sulphur namely: rhombic sulphur (S_R) and monoclinic (S_M). The transition temperature 96.5 °C, implying that at this temperature, the two forms of sulphur, S_R and S_M are in equilibrium. In other words, at room temperature and 1 atm. S_R is stable and changes to S_M , if heated to the temperature of 96.5 °C. S_M is stable at this temperature until it reaches a temperature of 119 °C.

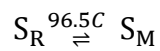

In addition to the above forms, other forms are liquid sulphur (S_L) and vapour sulphur (S_V). This gives a total phase of four for sulphur (Fig. 10.4).

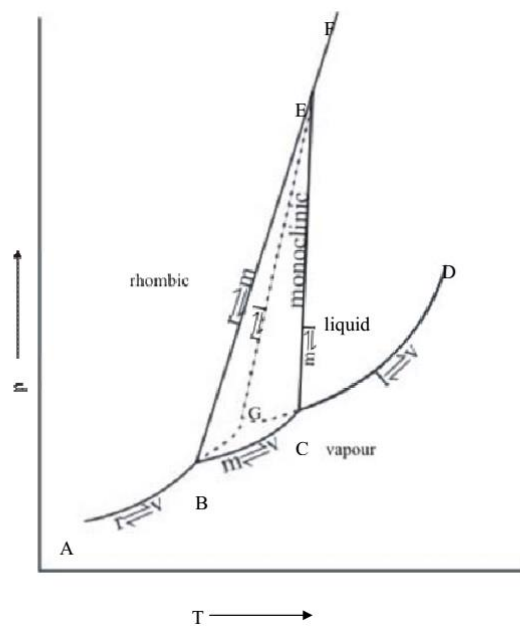

Figure 10.4: Phase diagram of sulphur system

However, it is impossible to have a four-phase equilibrium for one component system like sulphur system. The features of sulphur system are described in Table 10.3.

Table 10.3: Description of phase diagram of sulphur

S/N	Point	Process	Phase in Equilibrium	Degree of Freedom
1	Curve	Sublimation curve of rhombic sulphur	$R \rightleftharpoons V$	1
2	Curve BC	Sublimation curve of monoclinic sulphur	$M \rightleftharpoons V$	1
3	Curve CD	Vapourization curve of liquid sulphur	$L \rightleftharpoons V$	1
4	Curve BE	Transition line of rhombic to monoclinic	$R \rightleftharpoons M$	1
5	Curve CE	Fusion line of monoclinic sulphur	$M \rightleftharpoons L$	1
6	Curve EF	Fusion line of rhombic sulphur	$R \rightleftharpoons L$	1
7	Curve BG	Metastable sublimation of rhombic sulphur	$R \rightleftharpoons V$	1
8	Curve CG	Metastable vapourization curve of liquid sulphur	$L \rightleftharpoons V$	1
9	Curve GE	Metastable fusion curve of rhombic to liquid	$R \rightleftharpoons L$	1
10	Point B		Triple point (95.5 °C, 0.01 mmHg) $R \rightleftharpoons M \rightleftharpoons V$	0
11	Point C		Triple point (119.2 °C, 0.025 mmHg) $M \rightleftharpoons L \rightleftharpoons V$	0
12	Point E		Triple point (151 °C, 1290 atm)	0

			$R \rightleftharpoons M \rightleftharpoons L$	
13	Point G		Metastable triple point (114.5 °C, 0.03mmHg) $R \rightleftharpoons L \rightleftharpoons V$	0
14	Area to the left of ABF		Rhombic sulphur	2
15	Area above CD and right of CEF		Liquid sulphur	2
16	Area BCEB		Monoclinic sulphur	2
17	Area below ABCD		Vapour sulphur	2
18	Area BGEB		Metastable rhombic sulphur	2
19	Area CGEC		Metastable liquid sulphur	2

10.4 Phase Equilibria of Two Component Systems

Applying the phase rule to two component systems we have the degrees of freedom, $F=C-P+2=4-P$. when a single phase is present in a two component system, the number of degrees of freedom, $F=3$, means that three variables must be specified to describe the phase and these are temperature, pressure and composition of the phase. When two phases are present, the number of degrees of freedom, $4-P$, is reduced to 2, temperature and composition of the liquid phase. The values of the other variables get automatically fixed. If there are three phases present, then $F=4-3=1$ which means the value of only one variable needs to be stated to describe the phases. The maximum number of degrees of freedom for a two component system we see from the preceding discussion is three. In order to represent the variation in three variables graphically, we require a three dimensional diagram, a space model, which is difficult to construct on paper. To overcome this difficulty, a common practice that is adopted is to keep one of the variables constant. There are various types of equilibria that are generally studied at constant external pressure. Thus, out of the three

variables ($F=3$), one is already stated and the variation in the other two can be represented on a two dimensional diagram. Equilibria such as solid-liquid equilibria are such systems in which the gas phase is absent and hence are hardly affected by small changes in pressure. Systems in which the gas phase is absent are called condensed systems.

Measurements in these systems are generally carried out at atmospheric pressure. As these systems are relatively insensitive to small variation in pressure, the pressure may be considered constant. The phase rule takes the form

$$P+F=C+1 \dots\dots(3)$$

For such systems and in this form it is known as the reduced phase rule. For a two component system, this equation becomes $F=3-P$ where the only remaining variables are temperature and composition. Hence solid-liquid equilibria are represented on temperature – composition diagrams. In the following sections we will be discussing systems involving only solid-liquid equilibria.

Phase Diagram of Sodium Sulphate-Water System

The sodium sulphate-Water system forms two incongruent melting compounds viz:

1. $\text{Na}_2\text{SO}_4 \cdot 10\text{H}_2\text{O}$ (decahydrate)
2. $\text{Na}_2\text{SO}_4 \cdot 7\text{H}_2\text{O}$ (pentahydrate) – metastable

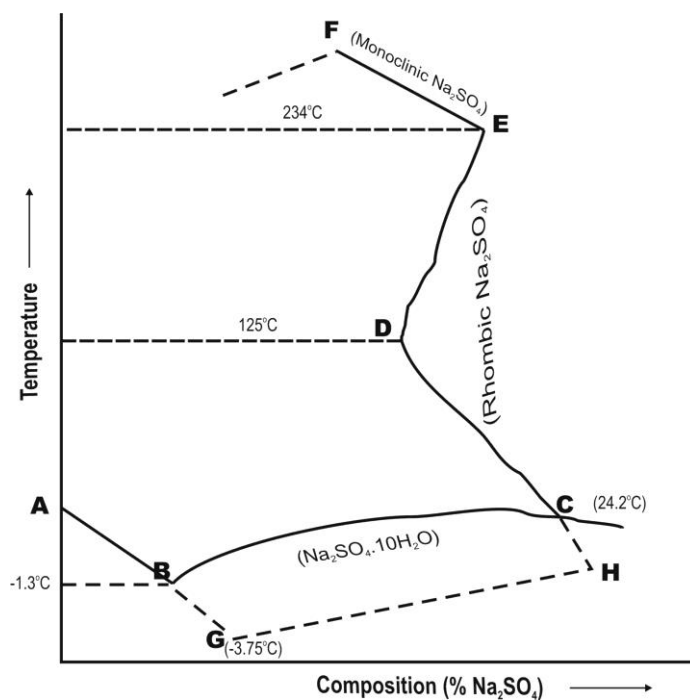

Figure 10.5: Phase diagram of sodium sulphate-water system

Besides, there are 2 forms of sodium sulphate – rhombic Na₂SO₄ and monoclinic Na₂SO₄.

Table 10.4: Description of phase diagram of sodium sulphate-water system

Position	Name of Process	Phase Equilibrium	Degree of Freedom
Curve AB	Fusion curve of ice	ice \rightleftharpoons solution	1
Curve BC	Solubility curve of dehydrate	Na ₂ SO ₄ ·10H ₂ O \rightleftharpoons solution	1
Curve CDE	Solubility curve of rhombic Na ₂ SO ₄	rhombic Na ₂ SO ₄ \rightleftharpoons solution	1
Curve EF	Solubility curve of monoclinic Na ₂ SO ₄	monoclinic Na ₂ SO ₄ \rightleftharpoons solution	1

Point B	Eutectic point	$\text{ice} \rightleftharpoons \text{Na}_2\text{SO}_4 \cdot 10\text{H}_2\text{O} \rightleftharpoons \text{ice}$	0
Point C	Incongruent point or transition point	$\text{Na}_2\text{SO}_4 \cdot 10\text{H}_2\text{O} \rightleftharpoons \text{rhombic Na}_2\text{SO}_4 \rightleftharpoons \text{solution}$	0
Point E	Enantriopic curve of Na_2SO_4	monoclinic $\text{Na}_2\text{SO}_4 \rightleftharpoons$ rhombic $\text{Na}_2\text{SO}_4 \rightleftharpoons \text{solution}$	0

Metastable Equilibrium

- BG is the metastable solubility curve of ice
- At point G, $\text{Na}_2\text{SO}_4 \cdot 7\text{H}_2\text{O}$ separates and it represents eutectic point
- GH is the metastable solubility curve of heptahydrate
- Point H is the metastable transition point at which heptahydrate decomposes to anhydrous Na_2SO_4 .

10.5 Raoult's Law and Ideal Liquids

An ideal solution can be defined as one in which activity of each constituent is equal to its mole fraction under all conditions of temperature, pressure and concentration. An ideal solution is formed without any evolution or absorption of heat and total volume is equal to the sum of volume of individual components. In addition, the molecules of an ideal solution exert the same force of cohesion on each other irrespective of the nature. Examples of ideal solutions are benzene-toluene, ethylene bromide-ethylene chloride, water-methylalcohol, chlorobenzene-bromobenzene, carbontetrachloride-silicon tetrachloride.

Suppose that two liquids, A and B are volatile and completely miscible to form an ideal solution, the partial vapour pressure of each constituent can be deduced from the Raoult's law.

Raoult's law states that

“the partial vapour pressure of any volatile constituent of a solution is equal to the vapour pressure of the pure constituent multiplied by the mole fraction of that constituent in solution over the whole concentration range at all temperatures.”

Mathematically,

$$P_A = P_A^0 X_A \dots \dots \dots (4)$$

and

$$P_B = P_B^0 X_B \dots \dots \dots (5)$$

The vapour pressure of the solution, P_{solution} is given as:

$$P_{\text{solution}} = P_A + P_B$$

$$P_{\text{solution}} = P_A^0 X_A + P_B^0 X_B \dots \dots \dots (6)$$

Since

$$X_A + X_B = 1,$$

Then,

$$X_A = 1 - X_B \dots \dots \dots (7)$$

Inserting Equation (7) in Equation (6), we have

$$P_{\text{solution}} = P_A^0 (1 - X_B) + P_B^0 X_B$$

$$P_{\text{solution}} = P_A^0 - P_A^0 X_B + P_B^0 X_B$$

$$P_{\text{solution}} = P_B^0 X_B - P_A^0 X_B + P_A^0$$

$$P_{\text{solution}} = (P_B^0 - P_A^0) X_B + P_A^0 \dots \dots \dots (8)$$

where,

P = vapour pressure of the ideal solution

P_A^0 = vapour pressure of constituent A

P_B^0 = vapour pressure of constituent B

P_A = partial vapour pressure of constituent A

P_B = partial vapour pressure of constituent B

X_A = mole fraction of constituent A = $\frac{n_A}{n_A + n_B}$

X_B = mole fraction of constituent B = $\frac{n_B}{n_A + n_B}$

n_A = number of moles of constituent A

n_B = number of moles of constituent B

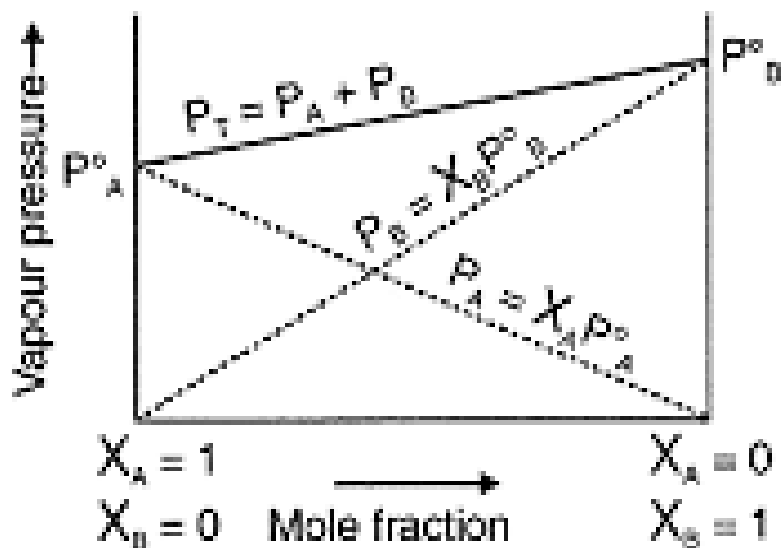

Figure 10.6: Vapour pressure of an ideal solution

Figure 10.6 shows the vapour pressure of a binary solution that obeys Raoult's law. The solid line shows the total vapour pressure as a function of the mole fraction of component B, and the dotted lines are the partial pressures of the two components.

Example 1

Calculate the vapor pressure of a mixture containing 252 g of n-pentane ($M_w = 72$) and 1400 g of n-eptane ($M_w = 100$) at 20°C . The vapour pressure of n-pentane and n-eptane are 420 mm Hg and 36 mm Hg respectively.

Solution

According to Raoult's law, the vapor pressure exercised by a component of a mixture can be calculated as follows

$$P = P^\circ X$$

where, P = vapor pressure of the component in the mixture, P° = vapor pressure of the pure component and X = molar fraction of the component in the mixture.

$$\text{Moles n-pentane} = \frac{252}{72} = 3.5$$

$$\text{Moles n-eptane} = \frac{1400}{100} = 14$$

$$\text{Total moles} = 3.5 + 14 = 17.5 \text{ moles}$$

$$X_{\text{n-pentane}} = \frac{3.5}{17.5} = 0.2$$

$$X_{\text{n-eptane}} = \frac{14}{17.5} = 0.8$$

Thus,

$$P_{\text{n-pentane}} = 0.2 \times 420 = 84 \text{ mm Hg}$$

$$P_{\text{n-eptane}} = 0.8 \times 36 = 28.8 \text{ mm Hg}$$

and the vapor pressure of mixture is

$$P_{\text{solution}} = 84 + 28.8 = 112.8 \text{ mmHg}$$

Example 2

Calculate the boiling point (at 1 atm) of a solution containing 116 g of acetone ($M_w = 58$) and 72 g of water ($M_w = 18$) by using the following table:

Temperature (°C)	Vapour Pressure (atm)	
	Acetone	Water
60	1.14	0.198
70	1.58	0.312
80	2.12	0.456
90	2.81	0.694

Solution

A liquid starts to boil when its vapour pressure matches the atmospheric pressure (1 atm in this case). Thus, according to Raoult's law,

$$P_{\text{solution}} = X_{\text{acetone}} P^{\circ}_{\text{acetone}} + X_{\text{water}} P^{\circ}_{\text{water}} = 1 \text{ atm}$$

From the given data we can calculate the molar fractions

$$\text{Moles}_{\text{acetone}} = \frac{116}{58} = 2$$

$$\text{Moles}_{\text{water}} = \frac{72}{18} = 4$$

$$\text{Total moles} = 2 + 4 = 6$$

$$X_{\text{acetone}} = \frac{2}{6} = \frac{1}{3}$$

$$X_{\text{water}} = \frac{4}{6} = \frac{2}{3}$$

Thus,

$$P = \frac{2}{3} P^{\circ}_{\text{acetone}} + \frac{1}{3} P^{\circ}_{\text{water}} = 1 \text{ atm}$$

By trials, using the table, we can find the values of vapor pressure which satisfies the above equation. The best result is obtained by using the values at 80°C:

$$P = \frac{2}{3} \times 0.456 + \frac{1}{3} \times 2.12 = 1.01 \text{ atm}$$

Then, the boiling point is about 80°C.

Example 3

A mixture of water and acetone at 756 mm boils at 70°C. Calculate the percentage composition of the mixture using the following table:

Temperature (°C)	Vapour Pressure (atm)	
	Acetone	Water
60	1.14	0.198
70	1.58	0.312
80	2.12	0.456
90	2.81	0.694

Solution

According to Raoult's law

$$P = X_{\text{acetone}} P^{\circ}_{\text{acetone}} + X_{\text{water}} P^{\circ}_{\text{water}} = \frac{756}{760} = 0.995 \text{ atm}$$

By substituting the values at 70 °C we have

$$P = X_{\text{acetone}} \times 1.58 + X_{\text{acqua}} \times 0.312 = 0.995$$

and remembering that the sum of molar fractions is 1

Thus,

$$X_{\text{acetone}} \times 1.58 + 0.312 (1 - X_{\text{acetone}}) = 0.995$$

$$X_{\text{acetone}} \times 1.58 + 0.312 - 0.312 X_{\text{acetone}} = 0.995$$

$$X_{\text{acetone}} 1.26 + 0.312 = 0.995$$

$$X_{\text{acetone}} = \frac{0.995 - 0.312}{1.26} = 0.54$$

From which

$$X_{\text{water}} = 1 - 0.54 = 0.46$$

Considering 100 moles of solution,

we have 54 moles of acetone corresponding to $54 \times 58 = 3132$ grams and 46 moles of water corresponding to $46 \times 18 = 828$ grams. Eventually,

$$\% \text{ water} = \frac{828(100)}{3132+828} = 21\%$$

$$\% \text{ acetone} = 100 - 21 = 79\%$$

Distillation of an Ideal Mixture

Consider the boiling point versus composition diagram for an ideal liquid as shown Fig. 10.7.

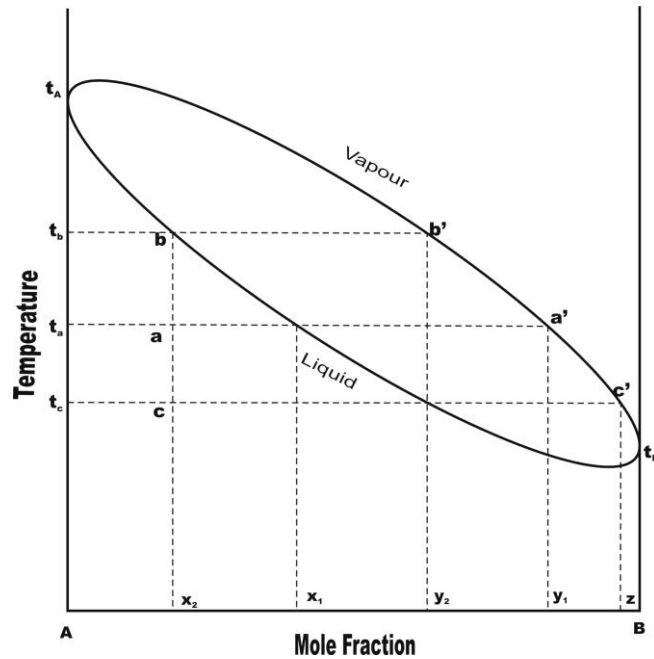

Figure 10.7: Temperature-mole fraction of ideal liquid

Heating X_1 to its boiling point, t_A (i.e. the point at which the vapour pressure is equal to the atmospheric pressure), the vapour produced will have the composition, Y_1 . Since $Y_1 > X_1$, the vapours are richer in the more volatile component B and the residue liquid richer in less volatile component A.

In the same vein, heating X_2 to its boiling point, t_b results in vapours with composition Y_2 . Since $Y_2 > X_2$, the vapours are richer in the more volatile component B and the residue liquid richer in the less volatile component A.

Thus, if this process continues, several times, the residue liquid will become richer and richer in A than the original solution until pure A is obtained. This is accompanied by an increase in boiling point from t_a to t_A , which is the boiling point of pure A. Likewise, condensing and redistilling the vapours obtained, new vapours of composition Z are obtained and the boiling point of the new solution is t_c . this indicates that the distillate is

richer in component B. Continuous process of condensing and redistilling produces pure B only.

Thus, it is possible to separate two or more ideal constituents into the pure components by means of fractional distillation.

Distillation Techniques

These consist of:

1. Differential distillation;
2. Eqm or flask distillation; and
3. Rectification.

Differential Distillation

It is so called, because concentration changes with time.

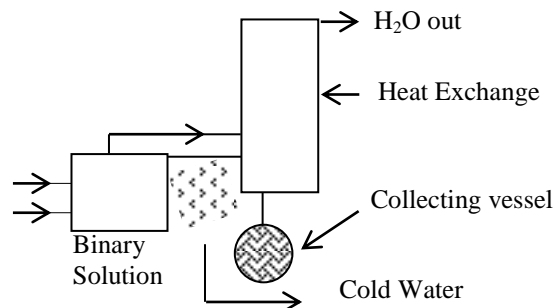

Figure 10.8: Sketch illustrating differential distillation

The liquid mixture is vapourized using the heat from the condenser steam. This system is in an unsteady state due to the varying composition with time.

Equilibrium or Flask Distillation

This can be represented diagrammatically as shown in Fig. 10.9.

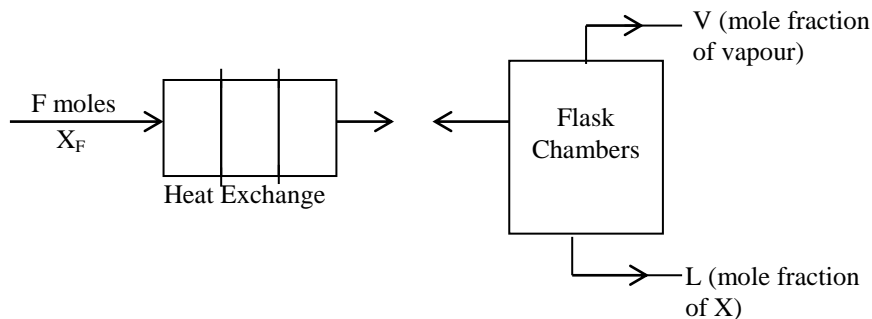

Figure 10.9: Sketch illustrating flask distillation

F = Feed (original mixture of two solvents)

In this, composition of liquid and vapour is constant. The flask chamber separates the liquid and vapour. The compositions are fixed and do not change hence called equilibrium distillation.

The mass balance for this distillation is

$Fx_F = Vy + Lx$. This is the mass balance for the mole volatile component.

$F = V + L$ (mass balance for content).

Rectification

Rectification is the series of vapourization and liquidization taking place within one vessel. Vapour from the first tank goes into the liquid in the second tank and heat transfer takes place. Part of the vapour Y_1 is condensed and part of the liquid X_2 is vapourised. Y_2 then moves into X_3 and the process continues. Therefore the concentration of the more volatile component will increase the vapour phase since Y_3 has a greater concentration of the more volatile component. When the distillate is taken up the system is said to be under total reflux. This can be represented diagrammatically as shown in Fig. 10.10.

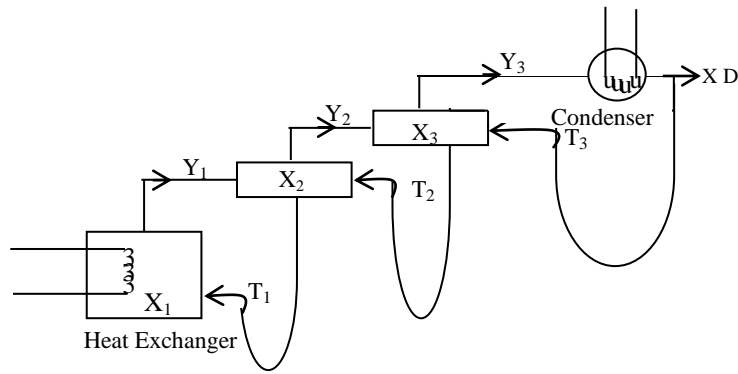

Figure 10.10: Sketch illustrating Rectification

where,

Y_1, Y_2, Y_3 = mole fraction of the different vapours going out.

X_1, X_2, X_3 = Liquid

X_D = mole fraction of the distillate

Note that,

$X_3 > X_2 > X_1$ and

$T_1 > T_2 > T_3$

Deviations from Raoult's Law

Positive Deviation

Let us consider a binary solution with components A and B. If the force of attraction between molecular of and A and B in the solution are weaker than that of between A—A and B—B, then the tendency of escaping of molecules A—B from the solution becomes more than that of pure liquids. The total pressure of the solution will be greater than the corresponding vapour pressure of ideal solution of the same component A and B. This type of solution shows positive deviation from Raoult's law. The positive deviation of solution is shown in figure. Some energy is lost when we mix both solutions. This reaction is endothermic reaction. For Endothermic reaction ΔH is always positive

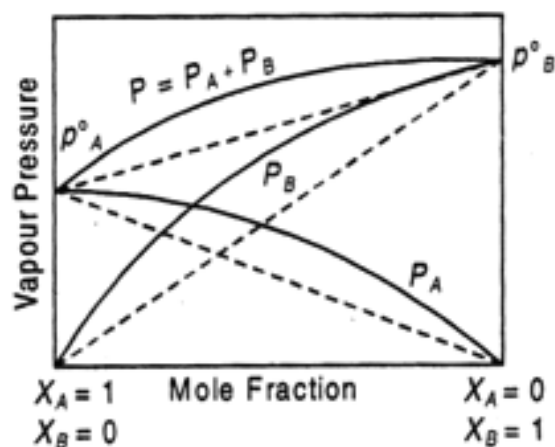

Figure 10.11: Positive deviation from Raoult's Law

Negative Deviation

Let us consider a binary solution which has components A and B. If the force of attraction between molecular of and A and B in the solution are stronger than that of between A—A and B—B, then the tendency of escaping of molecules A—B from the solution becomes less than that of pure liquids. The total pressure of the solution will be lower than the corresponding vapour pressure of ideal solution of the same component A and B. This type of solution shows negative deviation from Raoult's law. The negative deviation of solution is shown in figure. Some energy is released when we mix both solutions. This reaction is exothermic reaction. For Exothermic reaction ΔH is always negative

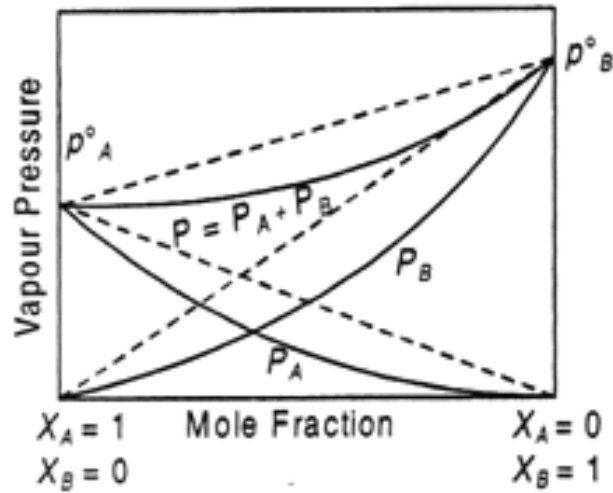

Figure 10.12: Negative deviation from Raoult's Law

10.6 Azeotropes

These are also referred to as constant boiling mixtures. These are liquids or mixtures of liquids which nevertheless distill unchanged at a definite temperature. There are minimum and maximum boiling azeotropes.

Minimum Boiling Point Azeotropes (Constant Pressure)

When there is a mixture having a boiling point lower than any other, the boiling point composition curves takes the form shown in Fig. 10.13.

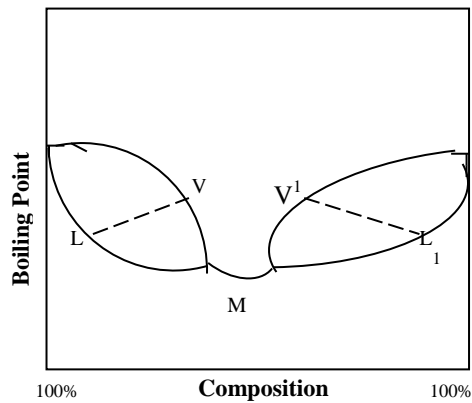

Figure 10.13: Graphical illustrating of minimum boiling point azeotrope

The liquid and vapour curves touch at the minimum (t) M. since here liquid and vapour are in equilibrium and have the same composition, the liquid mixture represented by M will therefore boil at a constant temperature and will distill over completely without a change in composition. But the compositions as well as the B pt of such mixtures change with pressure thus proving that they are not definite compounds. An example is ethanol and water with 100 °C and 78 °C as the boiling points respectively, but has an azeotrope of 70.5 °C.

Maximum Boiling Point Azeotropes (Constant Pressure)

Mixtures which exhibit marked negative deviation from Raoult's law yield system for which the boiling point curve has a maximum as shown in Fig. 10.14.

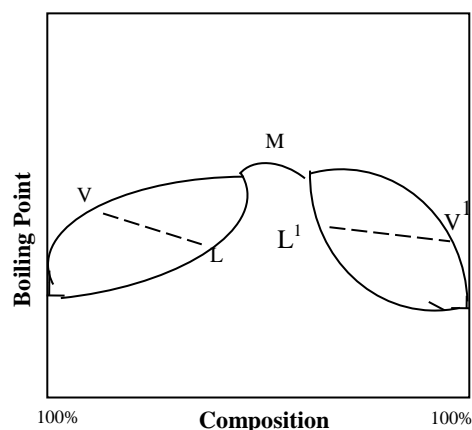

Fig. 10.14: Graphical illustrating of maximum boiling point azeotrope

The liquid and vapour curves meet at the maximum boiling point, M, where again the two phases have the same composition. The liquid M is thus an azeotropic mixture of maximum boiling point. It distils without change of composition at a definite temperature. Here the composition varies with external (pressure) indicating that the constant boiling mixture is not a definite compound. This system is not common. An example is the mixture formed by water and halogen acid. Note that fractional distillation cannot separate this type of mixture.

10.7 Colligative Properties

Physical properties can be divided into two categories. Extensive properties (such as mass and volume) depend on the size of the sample. Intensive properties (such as density and concentration) are characteristic properties of the substance; they do not depend on the size of the sample being studied. This section introduces a third category that is a subset of the intensive properties of a system. This third category, known as colligative properties, can only be applied to

solutions. By definition, one of the properties of a solution is a colligative property if it depends only on the ratio of the number of particles of solute and solvent in the solution, not the identity of the solute.

The properties that depend on the number of solute particles irrespective of their nature relative to the total number of particles present in the solution are called colligative properties

These are:

1. lowering of vapour pressure of the solvent,
2. depression of freezing point of the solvent,
3. elevation of boiling point of the solvent, and
4. osmotic pressure of the solution.

All colligative properties are related to each other by virtue of their common dependency on the concentration of the solute molecules. The solute present should not undergo any association or dissociation. If there is association of solute particles, the number of particles actually added will become less and correspondingly, the colligative properties will be lowered. Similarly, dissociation of solute particles results in increase in the number of the particles and a corresponding increase in the colligative particles.

The study of colligative properties has proved very helpful in the determination of molecular weight of the dissolved substances, which are non-volatile.

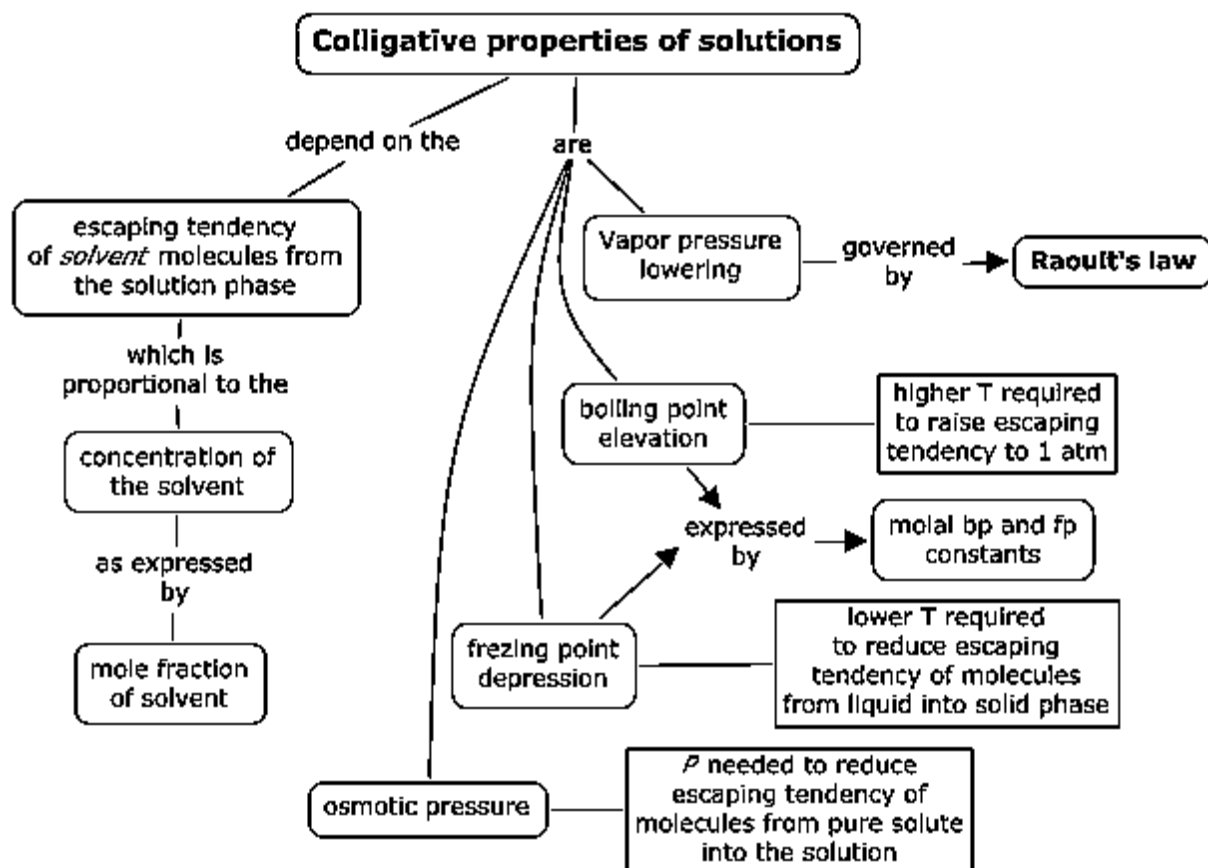

Figure 10.15: Concept of colligative properties

Practical Applications of Colligative Properties

1. Preparation of isotonic intravenous and isotonic lachrymal solutions.
2. Determination of the molecular weight of solutes or in the case of electrolytes, the extent of ionization.
3. They also may be used in experimental physiology as in immersion of tissues in salt solutions which are isotonic with

the tissue fluids to prevent changes or injuries of the tissues.

Vapour Pressure Lowering

Liquid molecules at the surface of a liquid can escape to the gas phase when they have a sufficient amount of energy to break free of the liquid's intermolecular forces. That vaporization process is reversible. Gaseous molecules coming into contact with the surface of a liquid can be trapped by intermolecular forces in the liquid. Eventually the rate of escape (vaporization) will equal the rate of capture (condensation) to establish a constant, equilibrium vapour pressure above the pure liquid. Vapour pressure is the pressure exerted by the vapour at equilibrium.

When a non-volatile solute is dissolved in a liquid solvent the vapour pressure of the solvent is lowered. Some of the surface molecules of the solvent are replaced by solute molecules which do not contribute in the vapour pressure and the surface area available for the escaping solvent molecules is reduced, because some of that area is occupied by solute particles.

Boiling Point Elevation

Boiling point elevation is a colligative property related to vapour pressure lowering. The boiling point is defined as the temperature at which the vapour pressure of a liquid equals the atmospheric pressure (760 mmHg). Due to vapour pressure lowering, a solution will require a higher temperature to reach its boiling point than the pure solvent. The boiling point of pure water is 100°C, but that boiling point can be elevated by the adding of a solute such as a salt. A solution typically has a measurably higher boiling point than the pure solvent.

The boiling point elevation, ΔT_b is a colligative property of the solution, and for dilute solutions is found to be proportional to the molal concentration, m of the solution:

$$\Delta T_b = K_b m \dots\dots\dots(9)$$

where, K_b = the boiling-point-elevation constant (Ebullioscopic constant).

Solutions may be produced for the purpose of raising the boiling point and lowering the freezing point, as in the use of ethylene glycol in automobile cooling systems. The ethylene glycol (antifreeze) protects against freezing by lowering the freezing point and permits a higher operating temperature by raising the boiling point.

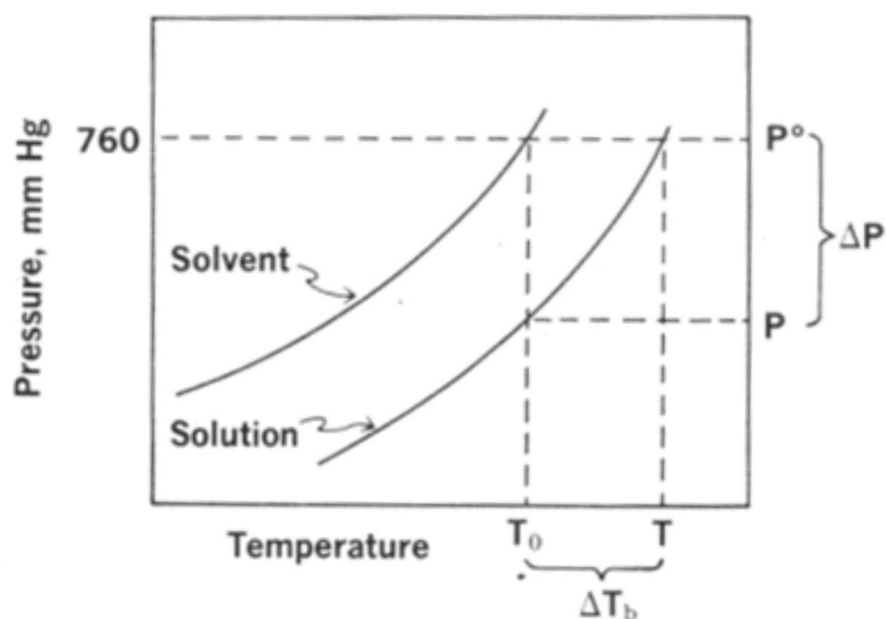

Figure 10.16: Phase diagram for a solution and the pure solvent indicating the boiling point elevation

Freezing Point Depression

The freezing point is depressed due to the vapour pressure lowering phenomenon. Freezing point (or melting point): is defined as the temperature at which the solid and the liquid phases are in equilibrium under a pressure of 1 atm. The

freezing point of pure water is 0°C, but that melting point can be depressed by the adding of a solute such as a salt. The use of ordinary salt (sodium chloride, NaCl) on icy roads in the winter helps to melt the ice from the roads by lowering the melting point of the ice. A solution typically has a measurably lower melting point than the pure solvent. A 10% salt solution was said to lower the melting point (Fig. 10.17).

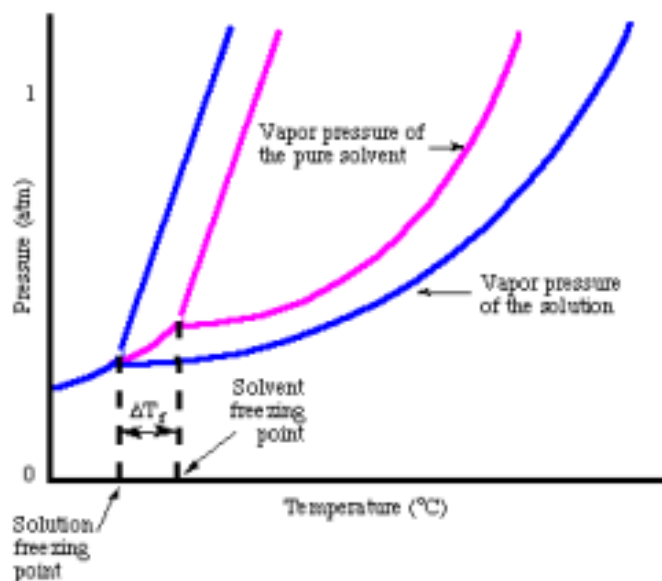

Figure 10.17: Phase diagram for a solution and the pure solvent indicating the freezing point depression

Osmotic Pressure

The most important colligative property from a pharmaceutical point of view is referred to as osmotic pressure. The osmotic pressure of a solution is the external pressure that must be applied to the solution in order to prevent it being diluted by the entry of solvent via a process known as osmosis. If two

solutions of different concentrations are separated by a semi-permeable membrane (only permeable to the solvent) the solvent will move from the solution of lower solute concentration to that of higher solute concentration (Fig. 10.18).

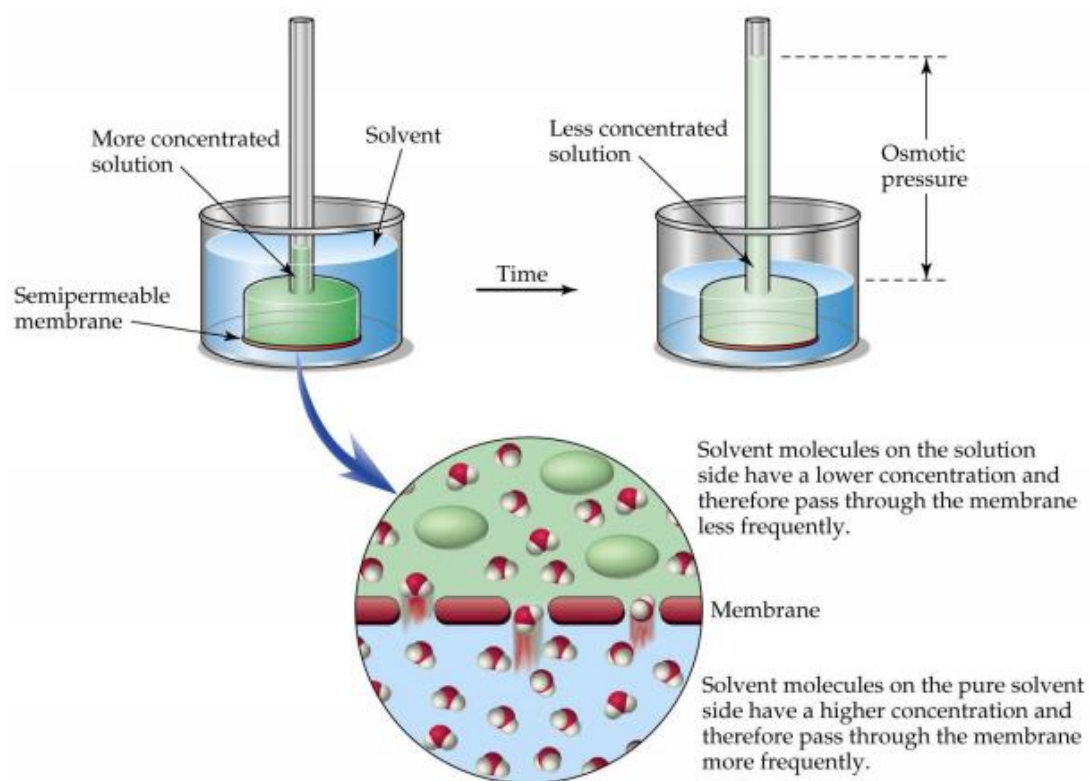

Figure 10.18: Osmosis set-up

The relationship between osmotic pressure, π and the concentration of a non-electrolyte is given for dilute solutions, which may be assumed to exhibit ideal behaviour, by the Van't Hoff equation:

$$\pi V = nRT \dots\dots\dots(10)$$

where, V = volume of solution, n = number of moles of solute, T = absolute temperature and R = gas constant.

The osmotic pressure of solutions of different nonelectrolytes is proportional to the number of molecules in each solution. The osmotic pressures of two nonelectrolyte solutions of same molal concentration are identical.

For example, a solution containing 34.2g of sucrose (mol wt. 342) in 1000 g of water has the same osmotic pressure as a solution containing 18.0 g of anhydrous dextrose (mol wt. 180) in 1000 g water. These solutions are said to be iso-osmotic with each other because they have identical osmotic pressures.

If the solute is an electrolyte, the previous equation must be modified to allow for the effect of ionic dissociation, because this will increase the number of particles in the solution. This modification is achieved by insertion of the Van't Hoff correction factor, *i* to give:

$$\pi V = inRT \dots\dots(11)$$

Although the above equation may be simpler to remember, the following form of the equation is more useful. This form of the equation has been derived by realizing that n/V gives the concentration of the solute in units of molarity, M.

$$\pi = iMRT \dots\dots(12)$$

where, the value of *i* approaches the number of ions produced by the ionization of the strong electrolytes. For weak electrolytes, *i* represents the total number of particles, ions and molecules together, in the solution.

Derivation of Molecular Weight of Solute from Raoult's Law of Lowering of Vapour Pressure

Consider a solution containing some non-volatile solute and let X_1 and X_2 be the mole fractions of the solvent and the solute respectively.

Thus, the vapour pressure of the solvent, P is given, according to Raoult's law as:

$$P_1 = X_1 P_1^o \dots \dots \dots (13)$$

The reduction in the vapour pressure of solvent, ΔP_1 , is given as:

$$\Delta P_1 = P_1^o - P_1 = P_1^o - X_1 P_1^o \dots \dots \dots (14)$$

$$\Delta P_1 = P_1^o (1 - X_1) \dots \dots \dots (15)$$

But,

$$X_2 = 1 - X_1$$

Then,

$$\Delta P_1 = X_2 P_1^o \dots \dots \dots (16)$$

In a solution containing several non-volatile solutes, the lowering of the vapour pressure depends on the sum of the mole fraction of different solutes

Thus,

$$\frac{\Delta P_1}{P_1^o} = \frac{P_1^o - P_1}{P_1^o} = X_2 \dots \dots \dots (17)$$

The expression on the left hand side of the equation as mentioned earlier is called lowering of vapour pressure and is equal to the mole fraction of the solute.

Hence, the molar molecular weight of the solute can be deduced by rewriting the above equation as:

$$\frac{P_1^o - P_1}{P_1^o} = X_2 = \frac{n_2}{n_1 + n_2} \dots \dots \dots (18)$$

Here n_1 and n_2 are the number of moles of solvent and solute respectively present in the solution. For dilute solutions $n_2 \ll n_1$, hence neglecting n_2 in the denominator we have

$$\frac{P_1^o - P_1}{P_1^o} = \frac{n_2}{n_1} \dots \dots \dots (19)$$

$$\frac{P_1^o - P_1}{P_1^o} = \frac{w_2 \times M_1}{w_1 \times M_2}$$

$$M_2 = \frac{w_2 \times M_1}{w_1} \times \frac{P_1^o}{P_1^o - P_1} \dots \dots \dots (20)$$

where, w_1 and w_2 are the masses and M_1 and M_2 are the molar masses of the solvent and solute respectively.

Example 4

The vapour pressure of pure benzene at a certain temperature is 0.850 bar. A non-volatile, non-electrolyte solid weighing 0.5 g when added to 39.0 g of benzene (molar mass 78 g mol^{-1}). Vapour pressure of the solution, then, is 0.845 bar. What is the molar mass of the solid substance?

Solution

Using,

$$M_2 = \frac{w_2 \times M_1}{w_1} \times \frac{P_1^o}{P_1^o - P_1}$$

where,

$P_1^o = 0.850 \text{ bar}$; $P = 0.845 \text{ bar}$; $M_1 = 78 \text{ g mol}^{-1}$; $w_2 = 0.5 \text{ g}$; $w_1 = 39 \text{ g}$; $M_2 = \text{molar mass of the solid substance}$

Then, we have

$$M_2 = \frac{0.5 \times 78}{39} \times \frac{0.850}{0.850 - 0.845}$$

Therefore,

$$M_2 = 170 \text{ gmol}^{-1}$$

Derivation of Molecular Weight of Solute from Raoult's Law of Boiling Point Elevation

Experiments have shown that for dilute solutions the elevation of boiling point, ΔT_b is directly proportional to the molal concentration of the solute in a solution.

Thus,

$$\Delta T_b \propto m \dots\dots\dots(21)$$

$$\Delta T = K_b m \dots\dots\dots(22)$$

where, m (molality) = number of moles of solute dissolved in 1 kg of solvent and the constant of proportionality, K_b = boiling point elevation constant or molal elevation constant (Ebullioscopic constant). The unit of K_b is $K.kg \text{ mol}^{-1}$.

If w_2 gram of solute of molar mass M_2 is dissolved in w_1 gram of solvent, then molality, m of the solution is given by the expression:

$$m = \frac{w_2/M_2}{w_1/1000} = \frac{1000 \times w_2}{M_2 \times w_1} \dots\dots\dots(23)$$

Substituting the value of molality, we have,

$$\Delta T_b = \frac{K_b \times 1000 \times w_2}{M_2 \times w_1} \dots\dots\dots(24)$$

$$M_2 = \frac{K_b \times 1000 \times w_2}{\Delta T_b \times w_1} \dots\dots\dots(25)$$

Thus, in order to determine M_2 , molar mass of the solute, known mass of solute in a known mass of the solvent is taken and ΔT_b is determined experimentally for a known solvent whose K_b value is known.

Example 5

18 g of glucose, $C_6H_{12}O_6$, is dissolved in 1 kg of water in a saucepan. At what temperature will water boil at 1.013 bar? K_b for water is $0.52 \text{ K kg mol}^{-1}$

Solution

Moles of glucose = $18 \text{ g}/180 \text{ g mol}^{-1} = 0.1 \text{ mol}$

Number of kilograms of solvent = 1 kg

Thus, molality of glucose solution = 0.1 mol kg^{-1}

For water, change in boiling point.

$$\Delta T_b = K_b \times m = 0.52 \text{ K kg mol}^{-1} \times 0.1 \text{ mol kg}^{-1} = 0.052 \text{ K}$$

Since water boils at 373.15 K at 1.013 bar pressure, therefore, the boiling point of solution will be $373.15 + 0.052 = 373.202 \text{ K}$

Example 6

The boiling point of benzene is 353.23 K. When 1.80 g of a non-volatile solute was dissolved in 90 g of benzene, the boiling point is raised to 354.11 K. Calculate the molar mass of the solute. K_b for benzene is $2.53 \text{ K kg mol}^{-1}$.

Solution

The elevation in the boiling point, $\Delta T_b = 354.11 \text{ K} - 353.23 \text{ K} = 0.88 \text{ K}$

Substituting these values, we get

$$M_2 = \frac{2.53 \text{ K.kg mol}^{-1} \times 1.8 \text{ g} \times 1000 \text{ g kg}^{-1}}{0.88 \text{ K} \times 90 \text{ g}} = 58 \text{ gmol}^{-1}$$

Therefore, molar mass of the solute, $M_2 = 58 \text{ gmol}^{-1}$

Derivation of Molecular Weight of Solute from Raoult's Law of Freezing Point Depression

Let T_f^0 be the freezing point of pure solvent and T_f be its freezing point when non-volatile solute is dissolved in it. Hence,

$$\Delta T_f = T_f^0 - T_f \dots \dots \dots (26)$$

is known as depression in freezing point.

Similar to elevation of boiling point, depression of freezing point, ΔT_f for dilute solution (ideal solution) is directly proportional to molality, m of the solution.

Thus,

$$\Delta T_f \propto m \dots \dots \dots (27)$$

$$\Delta T_f = K_f m \dots \dots \dots (28)$$

The proportionality constant, K_f , which depends on the nature of the solvent is known as freezing point depression constant or molal depression constant or Cryoscopic constant. The unit of K_f is $K.kgmol^{-1}$.

If w_2 gram of the solute having molar mass as M_2 , present in w_1 gram of solvent, produces the depression in freezing point ΔT_f of the solvent then molality of the solute is given by the equation:

$$m = \frac{w_2/M_2}{w_1/1000} = \frac{1000 \times w_2}{M_2 \times w_1} \dots \dots \dots (29)$$

Substituting the value of molality, we have,

$$\Delta T_f = \frac{K_f \times 1000 \times w_2}{M_2 \times w_1} \dots \dots \dots (30)$$

$$M_2 = \frac{K_f \times 1000 \times w_2}{\Delta T_f \times w_1} \dots \dots \dots (31)$$

Thus, for determining the molar mass of the solute we should know the quantities w_1 , w_2 , ΔT_f , along with the molal freezing point depression constant. The values of K_f and K_b , which depend upon the nature of the solvent, can be ascertained from the following relations:

$$K_f = \frac{R \times M_1 \times T_f^2}{1000 \times \Delta H_{\text{fus}}}$$

$$K_b = \frac{R \times M_1 \times T_b^2}{1000 \times \Delta H_{\text{vap}}} \dots \dots \dots (32)$$

Here the symbols R and M_1 stand for the gas constant and molar mass of the solvent, respectively and T_f and T_b denote the freezing point and the boiling point of the pure solvent respectively in kelvin. Further, ΔH_{fus} and ΔH_{vap} represent the enthalpies for the fusion and vapourisation of the solvent, respectively.

CHAPTER ELEVEN

11.0 Transport and Thermodynamic Properties of Electrolytic Solution

All chemical interactions are electrical at the atomic level. Therefore, in a sense, all chemistry is electrochemistry. Electrochemistry is the study of solutions of electrolytes and that of the phenomenon occurring at electrode immersed in these solutions.

11.1 Ionic Theory of Arrhenius

Ions are electrically charged atoms or molecules. They are either positively charged (cations) or negatively charged (anions).

According to Arrhenius, a neutral molecule, AB dissociated at equilibrium as shown below:

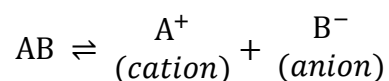

Arrhenius theory suggests that the transport numbers of both cations and anions should increase equally with increasing dilution.

11.2 Electrolytes

Electrolytes are compounds, either in molten form or solution, which allow electricity to pass through them, resulting in chemical decomposition.

Based on their tendency to ionize, electrolytes can be classified as:

1. Strong electrolytes
2. Weak electrolytes

Strong electrolytes are those which ionize completely while weak electrolytes ionize partially. Solutions of electrovalent salts are examples of strong electrolytes. Common examples of weak electrolytes are water, all organic acids, phenols and trioxocarbonate (IV) acid.

11.3 Ostwald's Dilution Law

Ostwald's dilution law is based on Arrhenius theory of weak electrolytic dissociation, according to which all weak electrolytes are partially dissociated into charged particles and dissociation is complete only at infinite dilution.

Consider a binary electrolyte, AB, which dissociates into charged ions, A⁺ and B⁻ as shown below:

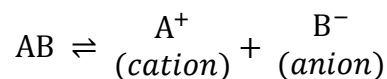

Applying the law of mass action, we have

$$K_a = \frac{a_{A^+} \times a_{B^-}}{a_{AB}} \dots \dots \dots (1)$$

where,

a = ionic activity = c x f (c = concentration and f = activity coefficient. f ≠ 1 for concentrated solutions and f = 1 for dilute solutions)

Thus, for dilution solutions,

$$K_c = \frac{C_{A^+} \times C_{B^-}}{C_{AB}} \dots \dots \dots (2)$$

Let the degree of dissociation be α, then

$$C_{A^+} = C_{B^-} = C\alpha \text{ and } C_{AB} = C(1 - \alpha)$$

Hence,

$$K_c = \frac{C\alpha \times C\alpha}{C(1 - \alpha)} \dots \dots \dots (3)$$

$$K_c = \frac{C^2\alpha^2}{C(1 - \alpha)}$$

$$K_c = \frac{C\alpha^2}{(1 - \alpha)} \dots \dots \dots (4)$$

where, K_C = dissociation constant/ionization constant of electrolytes.

If 1 g of molecule of the electrolyte is dissolved in V litres of the solution, then

$$V = \frac{1}{C} \dots \dots \dots (5)$$

where, V = dilution of the solution

Inserting Equation (5) in Equation (4), we have

$$K_c = \frac{\alpha^2}{V(1 - \alpha)} \dots \dots \dots (6)$$

Equation (6) is the mathematical expression of Ostwald's Dilution Law.

In case of weak electrolytes, the value of α is negligibly small so that $1 - \alpha \approx 1$

Hence, Equation (6) becomes

$$K_c = \frac{\alpha^2}{V}$$

$$\alpha = \sqrt{K_c V} \dots \dots \dots (7)$$

This shows that the degree of dissociation of weak electrolyte is directly proportional to the square root of dilution.

In case of strong electrolytes, α is quite large and is not negligible

Thus,

$$K_c = \frac{\alpha^2}{V(1 - \alpha)}$$

Solving quadratically,

$$\alpha = \frac{-K_c V \pm \sqrt{K_c V^2 + 4K_c V}}{2} \dots \dots \dots (8)$$

11.3 Colligative Properties of Electrolytes

Since electrolytes have the tendency of dissociating into ions, thereby increasing the number of particles in the solutions, their colligative properties are higher than those of non-electrolytes with the same concentrations with the electrolytes.

Thus, the colligative properties of electrolytes are expressed as follows:

$$\Delta P = i(\Delta P)_o = iP^o X_2 \dots \dots \dots (9)$$

$$\Delta T_f = i(\Delta T_f)_o = iK_f C \dots \dots \dots (10)$$

$$\Delta T_b = i(\Delta T_b)_o = iK_b C \dots \dots \dots (11)$$

$$\pi = i(\pi)_o = i \frac{nRT}{V} \dots \dots \dots (12)$$

where,

ΔP = vapour pressure lowering for electrolytes

$(\Delta P)_o$ = vapour pressure lowering for non-electrolytes

ΔT_f = freezing point depression for electrolytes

$(\Delta T_f)_o$ = freezing point depression for non-electrolytes

ΔT_b = boiling point elevation for electrolytes

$(\Delta T_b)_o$ = boiling point elevation for non-electrolytes

π = osmotic pressure for electrolytes

$(\pi)_o$ = osmotic pressure for non-electrolytes

i = van't Hoff factor = ratio of the colligative effect produced by a definite concentration of the electrolyte to the effect observed for the same concentration of a non-electrolyte.

K_f = freezing point depression constant

K_b = boiling point elevation constant

Suppose,

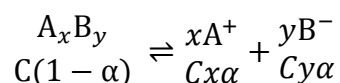

Total number of moles is given as

$$C_t = C(1 - \alpha) + Cx\alpha + Cy\alpha$$

$$C_t = C[1 + \alpha(x + y - 1)] \dots \dots \dots (13)$$

Let $x + y = n$, Equation (13) becomes

$$C_t = C[1 + \alpha (n - 1)] \dots \dots \dots (14)$$

But, $\Delta T_f = K_f C_t$,

Then, we have

$$\Delta T_f = K_f C_t = K_f C[1 + \alpha (n - 1)] \dots \dots \dots (15)$$

Inserting Equation (10) into Equation (15), we have

$$iK_f C = K_f C[1 + \alpha (n - 1)]$$

$$i = 1 + \alpha (n - 1)$$

$$\alpha = \frac{i - 1}{n - 1} \dots \dots \dots (16)$$

Example 1

The van't Hoff factor for the solute in 0.100 M NiSO₄ is 1.19. What would this factor be if the solution behaved as it were 100%?

Solution

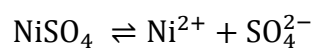

Using,

$$\alpha = \frac{i - 1}{n - 1}$$

where,

$$\alpha = 100\% = 1$$

$$i = ?$$

$$n = x + y = 1 + 1 = 2$$

Hence,

$$1 = \frac{i - 1}{2 - 1}$$

$$1 = \frac{i - 1}{1}$$

$$i - 1 = 1$$

$$i = 1 + 1$$

$$i = 2$$

Therefore, van't Hoff factor, $i = 2$, if the solution behaved as if it were 100% dissociated

11.4 Electrolysis

Electrolysis is a fragment of electrochemistry, which involves the chemical transformation by the passage of electricity. Electrolysis is the decomposition of an electrolyte with the passage of an electric current via metal plates/strips known as electrodes (i.e. cathode and anode). There are essentially three domains of electrolysis as depicted in Table 11.1.

Table 11.1: Domains of electrolysis

S/N	Ionic	Interfacial	Electrodes
-----	-------	-------------	------------

		Phenomenon	
1.	Burning of ion in solution and in fused state	Double Layer theory Adsorption	Kinetic and Mechanism of electrode reaction
2.	Ionic Equilibria	Electrokinetic Phenomenon	Electron transfer reaction
3.	Transport Process	Colloidal systems	Electrocatalytic processes
4.	Potential determining ion reaction reversible electrode potential	Ion Exchange	

Faraday's Laws of Electrolysis

First Law

It states that

“the mass, m of a substance involved in the reaction (either discharged or deposited) at the electrodes is directly proportional to the quantity of electricity, Q passed through the electrolytic solution”

Mathematically, /Z/

$$m \propto Q \dots \dots (17)$$

But, $Q = It$

Hence, Equation (17) becomes

$$m \propto It$$

$$m = ZIt \dots \dots (18)$$

where, Q = quantity of electricity, I = current in ampere, t = time in second and Z = electrochemical equivalent

Second Law

It states that

“when the same quantity of electricity is passed through solutions of different electrolytes, the number of moles of element deposited is inversely proportional to the charges of the ions of the element.”

Mathematically,

$$\frac{m}{M} = \frac{Q}{|Z|F}$$

$$\frac{m}{M} = \frac{It}{|Z|F} \dots \dots (18)$$

where,

m = mass of the element discharged or deposited

M = molar mass of the element discharged or deposited

|Z| = charge of the ion

F = Faraday constant = 96500 coulombs

This implies that for every electron, 1F is involved. For instance,

Example 2

A given quantity of electricity was passed through a voltmeter of two different electrolytes, containing Cu^{2+} and Ag^+ . At the end of the process, 0.64 g of copper has been deposited. How much silver was deposited in the second cell? ($\text{Ag} = 108 \text{ gmol}^{-1}$, $\text{Cu} = 64 \text{ gmol}^{-1}$, $F = 96500 \text{ c}$).

Solution

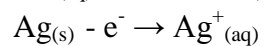
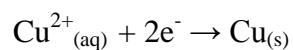

But, the number of electrons must be equal in the two half-equations

Hence,

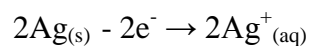

Addition of the two half-equations gives

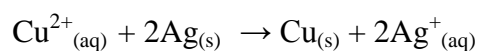

This implies that in each cell, $2F = 2e^{-}$

For copper,

$$\frac{m}{M} = \frac{Q}{|Z|F}$$

where,

$$m = 0.64 \text{ g}$$

$$M = 64 \text{ gmol}^{-1}$$

$$|Z| = 2$$

$$F = 2 \times 96500 \text{ coulombs (for } 2\text{e}^{-}\text{)}$$

$$Q = ?$$

Hence,

$$\frac{0.64}{64} = \frac{Q}{2 \times 2 \times 96500}$$

$$Q = 3860 \text{ c}$$

This is the quantity of electricity that was passed through the voltmeter

For Silver,

$$\frac{m}{M} = \frac{Q}{|Z|F}$$

where,

$$m = ?$$

$$M = 2 \times 108 \text{ gmol}^{-1}$$

$$|Z| = 2$$

$$F = 2 \times 96500 \text{ coulombs (for } 2e^-)$$

$$Q = 3860 \text{ c}$$

Hence,

$$\frac{m}{2 \times 108} = \frac{3860}{2 \times 2 \times 96500}$$

$$m = 2.16 \text{ g}$$

Therefore, the mass of silver deposited in the second cell = 2.16 g

11.5 Electrolytic Conductance

The resistance of an electrolytic conductor to current passage can be determined by the application of Ohm's Law to such conductors. As it is well known, the resistance of any conductor is directly proportional to its length and inversely to its cross sectional area.

That is,

$$R = \rho \frac{l}{A} \dots \dots \dots (19)$$

where,

R = resistance in ohms,

l = Length in cm

A = Area in Sq cm (cm^2)

ρ = specific resistivity

The value of ρ depends on and is characteristic of the nature of the conductor.

It is more convenient for an electrolyte solution to speak of conductance rather than of resistance. These quantities are reciprocally related, conductance L is calculated from the measured resistance.

$$L = \frac{1}{R} = \frac{1}{\rho} \left(\frac{A}{l} \right) \dots \dots \dots (20)$$

$$L = K \left(\frac{A}{l} \right) \dots \dots \dots (21)$$

where,

K = specific conductance.

Although specific conductance is a precipitate of conducting medium in dealing with solutions of electrolyte, a quantity of greater significance is the equivalent conductance (Λ).

Equivalent Conductance

The equivalent conductance of an electrolyte is the conductance of a volume of solution containing one equivalent weight of dissolved substance when placed between two parallel electrode 1cm apart and large enough to contain between them all of the solution.

Mathematically,

$$\Lambda = KV \dots \dots (22)$$

where, V = volume of solution

If concentration, C of the solution is gram equivalent per litre,

V is given as

$$V = \frac{1000}{C}$$

Thus, Equation (22) becomes

$$\Lambda = \frac{1000}{C} \times K \dots \dots (23)$$

Unit of equivalent conductance is $\text{ohm}^{-1}\text{cm}^2\text{equiv}^{-1}$

Molar Conductance

Molar conductance, μ is defined as the conductance of a volume of solution containing 1 mole of solute, the solution being placed between the two electrodes 1 cm apart and large enough to contain in between them all of the solution.

Mathematically,

$$\mu = KV \dots \dots (24)$$

where, V = volume of solution

If concentration, C of the solution is gram equivalent per litre,

V is given as

$$V = \frac{1000}{C}$$

Thus, Equation (24) becomes

$$\mu = \frac{1000}{C} \times K \dots \dots (25)$$

Unit of equivalent conductance is $\text{ohm}^{-1}\text{cm}^2\text{mol}^{-1}$. **Note** that for an electrolyte containing two univalent ions, equivalent conductance is equal to molar conductance.

Variation of Conductance with Concentration

Both the specific conductance and equivalent conductance of a solution vary with concentration. For strong electrolytes at concentration up to several equivalent per litre, the specific conductance increases sharply with increase in concentration. In contrast, the specific conductance of weak electrolytes starts at lower values in dilute solution and increases much more gradually. In both cases, the increase in conductance with concentration is due to increase in the number of ions per unit volume of solution. In strong electrolytes the number of ion per cm^3 increases in proportion to the concentration.

In weak electrolytes the increase is not quite large because of the changing partial ionization of the solute and consequently the conductance does not go up as rapidly as in strong electrolyte. Unlike the specific conductance, the equivalent conductance of both strong and weak electrolytes increases with dilution. The reason is that the decrease in specific conductance is more than compensated by the increase in the value of $1/C$ on dilution and hence Λ goes up. The manner in which Λ varies is seen from Table 11.2 and the plot of Λ versus \sqrt{C} is given in Fig. 11.1.

Table 11.2: Equivalent conductances of electrolytes in aqueous solution at 25°C

Equi.	KCl	HCl	AgNO ₃	$\frac{1}{2}\text{H}_2\text{SO}_4$	$\frac{1}{2}\text{BaCl}_2$	C ₂ H ₄ O ₂
-------	-----	-----	-------------------	------------------------------------	----------------------------	--

0.0000	149.86	426.16	133.36	429.6	139.98	390.7
0.0001	-	-	-	-	-	134.7
0.0005	147.81	422.7	131.36	413.1	135.96	67.7
0.001	146.95	421.36	130.51	399.5	134.34	49.2
0.005	143.05	415.80	127.20	364.9	128.02	22.9
0.01	141.27	412.00	124.76	336.4	123.94	16.3
0.02	138.34	407.24	121.41	308.0	119.09	11.6
0.05	133.37	399.09	115.24	272.6	111.48	7.4
0.10	128.96	391.32	109.14	250.8	105.19	-
0.20	123.9	379.6	101.8	234.3	98.6	-
0.50	117.2	359.2	-	225.5	88.8	-
1.0	111.9	322.8	-	-	80.5	-

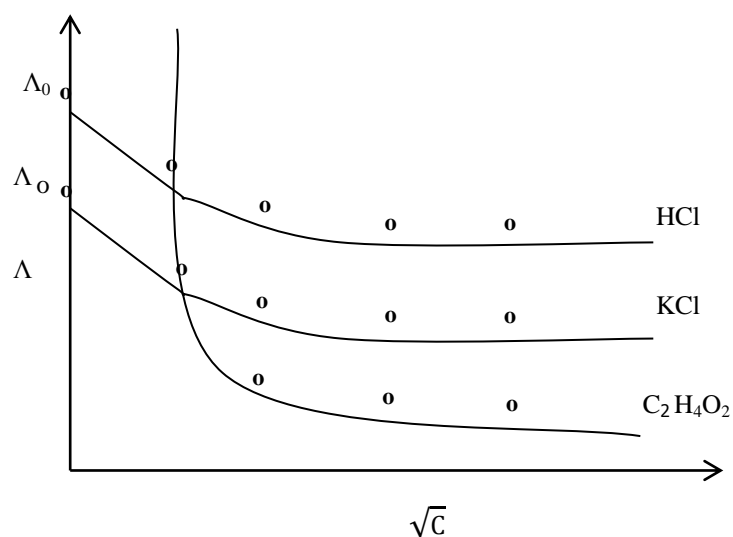

Figure 11.1: Plot of Λ against \sqrt{c} for strong and weak electrolytes

It may be seen from these that Λ for strong and weak electrolytes behaves differently on decrease in concentration. On dilution of a strong electrolyte Λ rapidly approaches the limiting value of the conductance at zero concentration Λ_0 .

On the other hand, although the equivalent conductance of weak electrolyte decreases rapidly on dilution, it is still very far from the limit.

11.6 Equivalent Conductance at Infinite Dilution

Kohlrausch first suggested the molar conductance at infinite dilution of a large number of electrolytes and found that in all cases, it was the sum of two quantities, one due to the anion and the other to the cation. Each ion contributes its own conductivity to the total.

This can be expressed mathematically as:

$$\Lambda_{\infty} = \Lambda_a + \Lambda_c \dots\dots\dots(26)$$

where,

Λ_{∞} = molar conductance at infinite dilution

Λ_a = molar conductance of anion

Λ_c = molar conductance of cation

Equation (26) is referred to as Kohlrausch's law of independent migration of ions. The values of molar conductances of some ions are given in Table 11.3.

Table 11.3: Molar conductances of some ions

Cation		Anion	
H ⁺	349.8	OH ⁻	198.6
K ⁺	73.5	½SO ₄ ²⁻	80.0
NH ₄ ⁺	73.5	Br ⁻	78.1
½Cu ²⁺	56.6	Cl ⁻	76.3
Na ⁺	50.1	NO ₃ ⁻	71.4
Ag ⁺	61.9	Ac ⁻	40.9

Example 3

The molar conductance of sodium acetate, hydrochloric acid and sodium chloride at infinite dilution are 91.0, 426.16 and 126.45 ohm⁻¹cm²mol⁻¹ respectively at 25 °C. Calculate the molar conductance at infinite dilution for acetic acid.

Solution

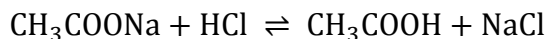

$$\Lambda_{\infty \text{CH}_3\text{COOH}} + \Lambda_{\infty \text{NaCl}} = \Lambda_{\infty \text{CH}_3\text{COONa}} + \Lambda_{\infty \text{HCl}}$$

$$\Lambda_{\infty \text{CH}_3\text{COOH}} = \Lambda_{\infty \text{CH}_3\text{COONa}} + \Lambda_{\infty \text{HCl}} - \Lambda_{\infty \text{NaCl}}$$

$$\Lambda_{\infty \text{CH}_3\text{COOH}} = 91.0 + 426.16 - 126.45 \Omega^{-1}\text{cm}^2\text{mol}^{-1}$$

$$\Lambda_{\infty \text{CH}_3\text{COOH}} = 390.71 \Omega^{-1}\text{cm}^2\text{mol}^{-1}$$

11.7 Applications of Conductance Measurements

Measuring the Dissociation Constant of Weak Electrolytes

Recall that

$$K_c = \frac{C\alpha^2}{(1-\alpha)} \dots \dots \dots (4)$$

If $\alpha = \frac{\Lambda_V}{\Lambda_{\infty}}$, (where, Λ_V = molar conductance at a dilution of V and Λ_{∞} = molar conductance at infinite dilution) Equation (4) becomes

$$K_c = \frac{C\Lambda_V^2}{\Lambda_{\infty}^2(1 - \Lambda_V/\Lambda_{\infty})} \dots \dots \dots (27)$$

$$K_c = \frac{C\Lambda_V^2}{\Lambda_{\infty}^2\left(\frac{\Lambda_{\infty} - \Lambda_V}{\Lambda_{\infty}}\right)}$$

$$K_c = \frac{C\Lambda_V^2}{\Lambda_\infty(\Lambda_\infty - \Lambda_V)} \dots \dots \dots (28)$$

If $V = \frac{1}{C}$ or $C = \frac{1}{V}$, Equation (28) becomes

$$K_c = \frac{\Lambda_V^2}{V \cdot \Lambda_\infty(\Lambda_\infty - \Lambda_V)} \dots \dots \dots (29)$$

where, $V =$ dilution

Determination of Solubilities of Sparingly Soluble Salts

Several sparingly soluble salts in H_2O e.g. $BaSO_4$, $AgCl$, PbS , etc, ionize in a single manner and for many purposes may be regarded as insoluble.

If $S =$ solubility of a given salt and $K =$ specific conductance, we have,

$$\Lambda_\infty = \frac{1000}{S} \cdot K \dots \dots \dots (30)$$

Or

$$S = \frac{1000}{\Lambda_\infty} \cdot K \dots \dots \dots (31)$$

Example 4

For a saturated solution of $AgCl$ at $25^\circ C$, K was found to be $3.41 \times 10^{-6} \text{ ohm}^{-1}\text{cm}^{-1}$. The value of K of water used to make up the solution = $1.60 \times 10^{-6} \text{ ohm}^{-1}\text{cm}^{-1}$. Determine the solubility of $AgCl$ in H_2O in mol/L at $25^\circ C$. (Λ_∞ for $AgCl = 138.3 \text{ ohm}^{-1}\text{cm}^{-1}\text{equiv}^{-1}$)

Solution

$$K_{AgCl} = K_{\text{solution}} - K_{\text{water}}$$

$$K_{\text{AgCl}} = 3.41 \times 10^{-6} - 1.60 \times 10^{-6}$$

$$K_{\text{AgCl}} = 1.81 \times 10^{-6} \text{ ohm}^{-1}\text{cm}^{-1}\text{equiv}^{-1}$$

Using,

$$S = \frac{1000}{\Lambda_{\infty}} \cdot K$$

$$S = \frac{1000 \times 1.81 \times 10^{-6}}{138.3}$$

$$s = 1.309 \times 10^{-5} \text{ mol/L}$$

Therefore, the solubility of AgCl = $1.309 \times 10^{-5} \text{ mol/L}$.

Conductimetric titration

Conductance measurement may be employed to determine the end point of various titration measurements.

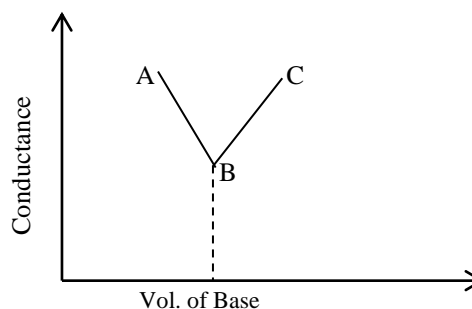

Figure 11.2: Titration of strong acid by strong base

From the Fig. 11.2, the titration graph will have the form. It is necessary to take a number of points to both sides of the equivalent point and to extrapolate the linear segment of the

equivalent point. Over the region AB, a more fast moving H^+ of the acid are replaced by the more slowly moving base cations with a segment for conductivity. After all the H^+ ions are removed, the conductivity raised between A and C as an excess of OH^- is added to the solution.

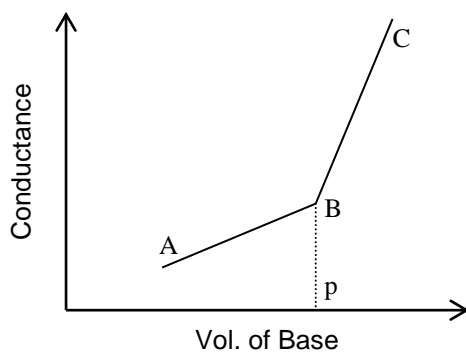

Figure 11.3: Titration of weak acid by strong base

This type of titration graph is obtained in this case. The conductivity initially rises from A to B as the salt of CH_3COONa is formed. Any contribution to overall conductivity by that of H^+ is largely suppressed by the buffering action of ethanoate ions. Beyond the equivalent point, the conductivity increases from B to C due to increase concentration of OH^- ions.

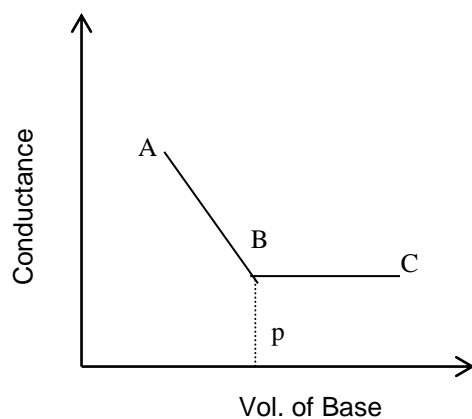

Figure 11.4: Titration of strong acid by weak base

An initial rapid decline over the region AB is due to the replacement of the mobile H^+ by cation of the weak base. From B to C, the weak base is added in excess to the solution of its salts so that the ionization is suppressed. Consequently, the conductivity of OH^- ion is negligible.

11.8 Applications of Ionic Theory

Hydrolysis of Salts

Consider a reaction,

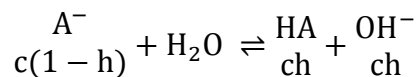

$$K_h = \frac{Ch \cdot Ch}{C(1-h)}$$

$$K_h = \frac{Ch^2}{1-h} \dots \dots \dots (32)$$

where,

K_h = hydrolytic constant

h = degree of hydrolysis = fraction of total salt that undergoes hydrolysis when equilibrium has been established
 C = molar concentration

Acids and Bases

For acid,

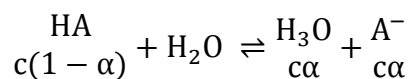

$$K_a = \frac{C\alpha \cdot C\alpha}{C(1 - \alpha)}$$

$$K_a = \frac{C\alpha^2}{1 - \alpha} \dots \dots \dots (33)$$

where,

K_a = dissociation constant of acid

For weak acids, $1 - \alpha \approx 1$, then Equation (33) becomes

$$K_a = C\alpha^2 \dots \dots \dots (34)$$

For Bases,

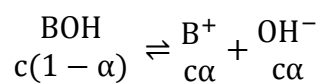

$$K_b = \frac{C\alpha \cdot C\alpha}{C(1 - \alpha)}$$

$$K_b = \frac{C\alpha^2}{1 - \alpha} \dots \dots \dots (34)$$

where,

K_b = dissociation constant of base

Buffer Solutions

Buffer solutions, as discussed in Chapter Six, are solutions, which are resistant to change in pH when some acid or base is added to them e.g CH_3COONa and CH_3COOH .

Consider the dissociation of ethanoic acid,



The dissociation constant, K_a is given as

$$K_a = \frac{[\text{CH}_3\text{COO}^-][\text{H}^+]}{[\text{CH}_3\text{COOH}]} \dots \dots \dots (35)$$

From Equation (1),

$$[\text{H}^+] = K_a \cdot \frac{[\text{CH}_3\text{COOH}]}{[\text{CH}_3\text{COO}^-]} \dots \dots \dots (36)$$

Since $[\text{CH}_3\text{COOH}] = [\text{Acid}]$ and $[\text{CH}_3\text{COO}^-] = [\text{Salt}]$, Equation (36) can be written as

$$[\text{H}^+] = K_a \cdot \frac{[\text{Acid}]}{[\text{Salt}]} \dots \dots \dots (37)$$

Taking Equation (37) to $-\log_{10}$, we have

$$-\log_{10}[\text{H}^+] = -\log_{10} \left(K_a \cdot \frac{[\text{Acid}]}{[\text{Salt}]} \right)$$

$$\text{pH} = -\log_{10} K_a - \log_{10} \left(\frac{[\text{Acid}]}{[\text{Salt}]} \right)$$

$$\text{pH} = \text{p}K_a - \left[-\log_{10} \left(\frac{[\text{Salt}]}{[\text{Acid}]} \right) \right]$$

$$\text{pH} = \text{pK}_a + \log_{10} \left(\frac{[\text{Salt}]}{[\text{Acid}]} \right) \dots \dots \dots (38)$$

Equation (38) is known as Henderson-Hasselbalch Equation.

Solubility Product

Consider the dissociation of AgCl as follows:

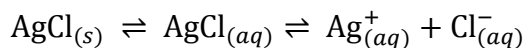

$$K_{sp} = \frac{[\text{Ag}^+][\text{Cl}^-]}{[\text{AgCl}]} \dots \dots \dots (39)$$

But, $[\text{AgCl}] = 1$, because the unionized AgCl is in contact with the solid AgCl

Thus,

$$K_{sp} = [\text{Ag}^+][\text{Cl}^-] \dots \dots \dots (40)$$

Generally, if

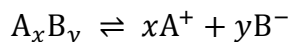

Then, the solubility constant, K_{sp} is given as

$$K_{sp} = [\text{A}^+]^x[\text{B}^-]^y \dots \dots \dots (41)$$

Example 5

The solubility product of BaCrO_4 is 2.0×10^{-10} at 25°C . Calculate the molarity of BaCrO_4 .

Solution



$$K_{sp} = [\text{Ba}^{2+}][\text{CrO}_4^{2-}]$$

$$\text{If } [\text{Ba}^{2+}] = [\text{CrO}_4^{2-}] = x$$

Thus,

$$2.0 \times 10^{-10} = x \cdot x$$

$$x^2 = 2.0 \times 10^{-10}$$

$$x = \sqrt{2.0 \times 10^{-10}}$$

$$x = 1.415 \times 10^{-5} \text{ mol/L}$$

Since $[\text{BaCrO}_4] = [\text{Ba}^{2+}] = [\text{CrO}_4^{2-}] = 1:1:1$, the molarity of $\text{BaCrO}_4 = 1.415 \times 10^{-5} \text{ mol/L}$.

11.9 Debye-Huckel Theory of Interionic Attraction

This states that each ion in solution is surrounded by an atmosphere of other ions whose net charge is opposite to that of the central ion. When the ions have no external force applied upon them, this atmosphere is spherical and symmetrically distributed about the central ion, when an external force is imposed as when a potential is applied across two electrodes immersed in the solution, the ions are set in motion.

Derby-Huckel pointed out that these effects as two folds:

1. The relaxation of the ionic atmosphere due to the applied potential
2. The electrophoretic effect

The first of these arises from ion-ion interaction, and based on the fact that any central ion and its atmosphere are oppositely charged. Because of this difference, the applied potential will cause the central ion and its atmosphere to move in opposite

direction: a central positive ion towards the cathode and its atmosphere towards the anode. The symmetry of the ionic atmosphere is thus destroyed; becoming distorted. In this state the force exerted by the atmosphere on the central ion is no longer uniform in all directions: but greater behind the ion than in front of it. Consequently the ion experiences a retarding force opposite to the direction of its motion and the ion is slowed down by these interionic attractions.

The electrophoretic effect arises from ion-solvent interactions based on the fact that an ion moving through a solution does not travel through a stationary medium. Ions are generally solvated and when these move they carry with them solvent molecules. Any positive ion migrating towards the cathode has to thread its way through a medium moving with negative ion towards the anode and vice versa. These counter currents make it more difficult for the ion to move through the solution. Debye-Huckel showed that these retarding effects on an ion produce a decrease in equivalent conductance dependent on the concentration.

Consequently, the equation for the limiting form (law) of the Debye-Huckel theory is shown below:

$$\log X_{\pm} = 0.5091Z_+Z_-\sqrt{\mu} \dots \dots \dots (42)$$

Or

$$\log X = 0.5091Z^2\sqrt{\mu} \dots \dots \dots (43)$$

where,

X = mean activity coefficient at 25 °C

Z₊ = cation charge

Z₋ = anion charge

μ = ionic strength = $\frac{1}{2} \sum C_i Z_i^2$

C = concentration

CHAPTER TWELVE

12.0 Thermochemistry

Thermochemistry is the branch of physical chemistry, which deals with the heat changes accompanying chemical and physical transformations. In accordance with the law of conservation of energy, when a fixed amount of one form of energy disappears, an equivalent amount of another form of energy reappears. Every chemical species—element or compound—is associated with certain fixed amount of internal energy, which is also referred to as chemical energy or intrinsic energy. The intrinsic energy is the total energy of the molecules and this consists partly of chemical energy, which depends on the chemical nature of the molecule (i.e. numbers and types of chemical bonds) and partly of mechanical energy (i.e. kinetic energy of motion, rotational and vibrational energies).

Like other forms of energy, chemical energy may be converted into heat energy and vice versa. The study of the relationship between heat energy and chemical energy is termed thermochemistry.

12.1 Exothermic and Endothermic Reactions

All chemical reactions are usually accompanied by changes in heat; and heat is either absorbed or evolved during chemical reactions.

Considering a general reaction represented as



Let 'a' and 'b' be the intrinsic energies of A and B respectively.

If $a > b$, the excess intrinsic energy associated with A will be liberated in the form of heat energy during the conversion of A to B. Such reactions which are accompanied by evolution of heat are known as exothermic reactions. If $a < b$, when B is formed heat energy will be absorbed to make for the deficiency. Such reactions which are accompanied by absorption of heat are called endothermic reactions.

A compound formed from an endothermic reaction is called an endothermic compound; it is very reactive; while those formed from exothermic reactions are known as exothermic compounds and are much less reactive than their starting chemical species.

12.2 Thermochemical Equation

An equation which indicates the evolution or absorption of heat in a reaction or process is called a **thermochemical equation**. In the computation of heat of reactions it is a convention to assume that the heat of formation of elements in their standard states (i.e. at 1 atmosphere and a constant temperature) is zero. The standard states of various forms of matter are as follows:

1. The physical states of the reactants or products influencing the magnitude of the heat evolved or absorbed in the reaction are represented by the following symbols, which are usually enclosed in brackets placed after the chemical formulae.
 - (g) for gaseous state
 - (l) for liquid state
 - (s) for solid state
 - (aq) for aqueous medium
2. Different allotropic forms of the same element are associated with different energies. Therefore in the case of elements, which exhibit allotropy, the name of the allotropic modification must be mentioned. For example, the case of carbon, we must write C (diamond) or C (graphite) as the case may be.

Conventionally, the heat change is indicated by ΔH or ΔE which is called the enthalpy change or change of heat content. ΔH carries a positive (+) or negative (-) sign with reference to the reacting system. Thus, $\Delta H = -x$ calories means that x calories of heat have been lost by the reacting system; and $\Delta H = +x$ calories means that x calories of heat have been gained by the reacting system.

At standard state, the heat of reactions is denoted by ΔE° or ΔH° at a given temperature. Thus, the reaction between carbon and oxygen at 25°C and 1 atm is represented as

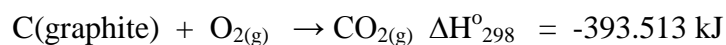

12.3 Heat of Reaction

The heat of reaction of a chemical change is the difference between heat contents (enthalpies of the products and those of the reactants at the reaction and is denoted by ΔH) when the number of molecules of the reactants indicated by the chemical equation have been completely reacted at a given temperature.

It is mathematically expressed as

$$\Delta H = \Sigma H_{(\text{products})} - \Sigma H_{(\text{reactants})}$$

where, Σ = summation sign

Heat energy is expressed in calories or joules, and the relationship between them is 1 calorie \equiv 4.814 joules

12.4 Various Types of Heat Changes

Standard Heat

Standard Heat of formation is defined as the amount of heat evolved or absorbed (ΔH_f° , ΔE°) when one mole of a substance is formed from its elements in their standard states at a specific temperature (which is usually taken to be 25 °C or 298 °K). For example, the heat formation of one mole of carbon dioxide CO_2 , at 298k is 393.513KJ as represented by the equation:

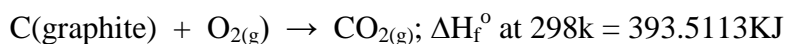

Since the heat of formation of the elements in their standard states is considered to be zero, the heat at formation of CO_2 is equal to the heat of the reaction representing the formation of the compound.

Note that in the reaction,

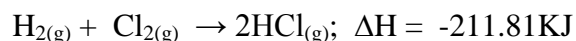

-211.816 KJ is not the heat of formation of HCl, since 2 g molecules of HCl are formed with release of 211.816 KJ of heat. Hence, according to definition, - 105.908 KJ is the heat of formation of HCl as



Heat of Combustion

The heat of combustion of an element or compound is the total amount of heat change accompanying the complete burning of one mole of a substance in excess oxygen at a given temperature under normal pressure.

For instance,

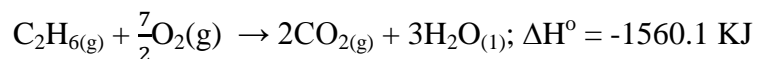

The determination of heat of combustion is carried out with an instrument called bomb calorimeter. The bomb is a strong steel vessel coated inside with enamel to resist the action of oxygen. It is fitted with a screw on lid.

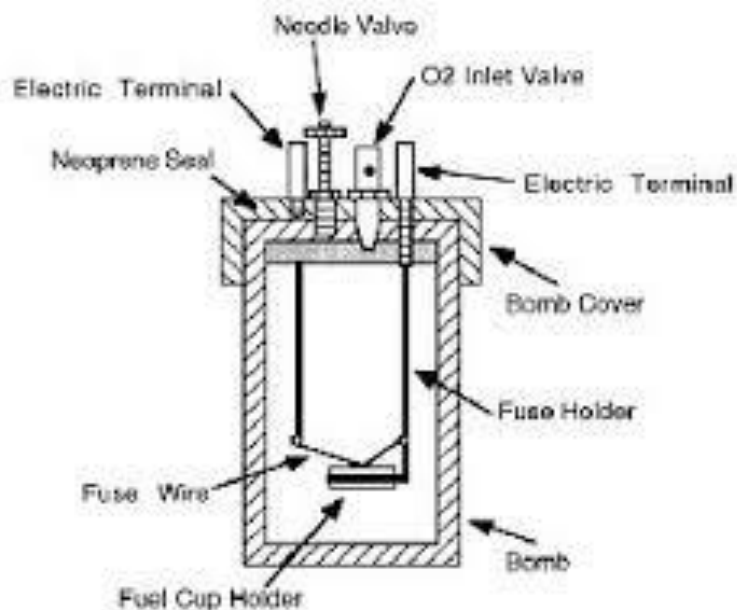

Figure 12.1: Bomb Calorimeter

The apparatus is calibrated by the measurement of temperature rise, resulting from the combustion. Generally, a known mass of benzoic (C_6H_5COOH) is taken for calibration. After calibration, the substance to be determined for heat of combustion is placed on the platinum support and above it, the two platinum wires are joined by a thin spiral of iron wire. The bomb is closed and oxygen introduced until the pressure inside is about 25 mmHg. This is evident by the production of electric spark, resulting in large amount of heat. The evolution of heat, therefore, raises the temperature of the H_2O around the calorimeter.

Heat of Neutralization

Heat of neutralization is defined as the change in enthalpy (heat content) of the system when one gram equivalent of an acid is completely neutralized by one gram equivalent of a base in very dilute solutions.

The dilute solutions are necessary so that on mixing the acid and base solutions thermal change due to dilution is made negligible. The heat of neutralization of strong base (e.g. NaOH) and strong acid (e.g. HCl) has been found to be a constant of value 57.0 KJ at 25 °C and 1 atm. But in the case of weak acid and strong base the value is less than 57.0 KJ. The difference is due to the heat of ionization of weak acid.

A weak acid or base is one, which in dilute solution is only partially ionized. As neutralization proceeds, the weak acid or weak base gradually gets ionized, finally reaching complete ionization. During the ionization, a certain amount of heat is absorbed to effect complete ionization; and this is responsible for the difference in neutralization values stated above. That is, while neutralization occurs between a weak acid and a strong base or vice versa, part of heat evolved during the process is used to effect complete ionization of weak acid or base as the case may be.

A typical reaction of neutralization is that between NaOH and HCl as represented below:

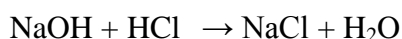

And the neutralization reaction is essentially between hydroxyl (OH⁻) and hydrogen ions (H⁺) to form water, H₂O



Heat of Hydrogenation

This is defined as the enthalpy change accompanying the conversion of one mole of unsaturated organic compound into a corresponding saturated compound by the reduction of the former with hydrogen.

Heat of Solution

The heat of solution is the heat change accompanying the dissolution of one mole of a solute in excess liquid and its value

depends on the final concentration of the solution. The heat of solution is usually reported as per mole of the dissolved substance (solids or gases) but for solutions of liquids the data is often tabulated as heat change per mole of solution.

The heat of solution depends upon the relative amounts of the substances being mixed and on whether they were initially taken as pure or one of them was introduced into a solution with a certain initial concentration at a given temperature and pressure.

The graph of heat change per mole of solution exhibits a shape like that in Fig. 12.2.

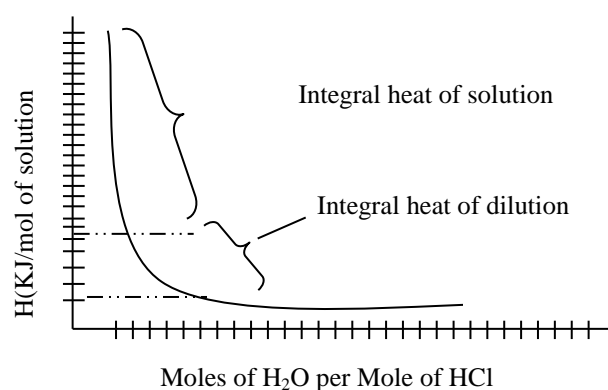

Fig. 12.2: Heat change against moles of H₂O per mole of HCl

Heat of Dilution

The heat of dilution is the enthalpy change when a solution of known concentration is further diluted by adding more solvent, and further addition of the solvent does not cause further heat change.

Note: Other heats of reaction include transition, atomization, vaporization, fusion, sublimation and dissociation.

12.5 Laws of Thermochemistry

For certain reactions, for examples, it is not convenient to measure the heat change calorimetrically in the laboratory. Hence, conventional procedure based on the principle of energy has been suggested which can be stated as follows:

1. Since enthalpy is directly proportional to mass, the enthalpy change (ΔH) is also directly proportional to the amount of substance reacted or produced in a reaction.
2. The change in enthalpy (ΔE or ΔH) for a reaction is equal in magnitude but opposite in sign to the change in enthalpy for the reverse reaction at the same conditions of temperature and pressure. That is, the heat of formation of any compound is equal in magnitude and of opposite sign to the heat of dissociation of that compound at a given temperature. For example the enthalpy of formation of liquid water from its elements hydrogen and Oxygen is $-285.83 \text{ KJ mol}^{-1}$ and the enthalpy of its dissociation is $285.83 \text{ KJ mol}^{-1}$. Thus, the process can be written as

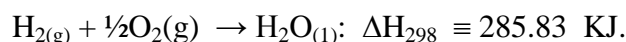

Or

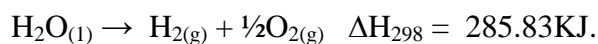

3. The total enthalpy change of reaction is the same regardless of whether the reaction is completed in one step or in several steps. This has been experimentally verified and is a derivative of the law of heats of reactions, which cannot be practically obtained by calorimetric measurements. This law is often called Hess's law or the law of constant heat summation; and often stated as: the resultant heat change in

a chemical reaction is the same whether the reaction takes place in one or several stages.

Illustration of the Hess Law

Consider a system in which the initial state is represented by the symbol A and the final state by the symbol and suppose that there are two ways by which the system can change from state A to state D:

A → D (first way) direct change,

Or

A → B → C → D (second way) step-wise change

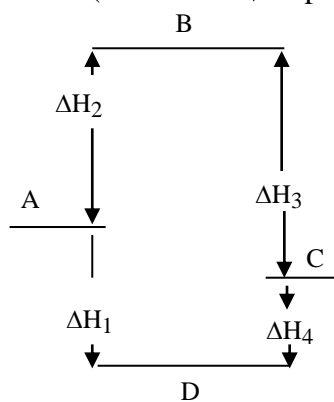

Figure 12.3: Hess's law in diagrammatic form

Hess's law requires that the enthalpy change accompanying the change A directly to D be identical to the sum of the three enthalpy changes accompanying the three changes from A to B to C to D as shown in the above diagram.

Thus,

$$\Delta H_1 = \Delta H_2 + \Delta H_3 + \Delta H_4$$

Or

$$\Delta H_D - \Delta H_A = \Delta H_1 = \Delta H_2 + \Delta H_3 + \Delta H_4$$

From the laws of thermochemistry, we get the following working rules:

1. Chemical equations can be reversed and the sign of ΔH is also changed.
2. Chemical equations may be added, subtracted, multiplied or divided by an integer whenever necessary as ordinary algebraic equations.

Example 1

Verify that the change in enthalpy (ΔH) for the reaction,

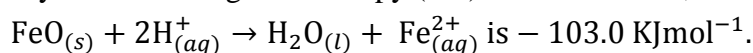

Given that the reaction proceeds in the following steps:

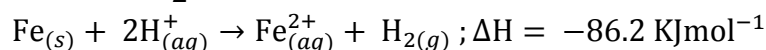
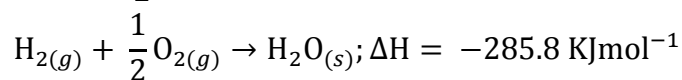
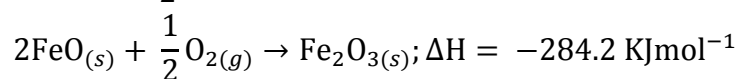
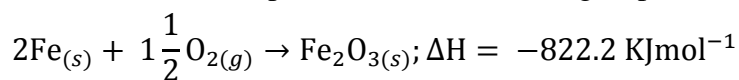

Solution

Let us name the chemical reaction steps as follows:

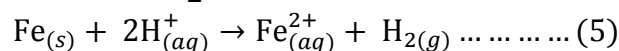
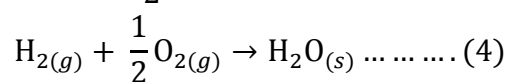
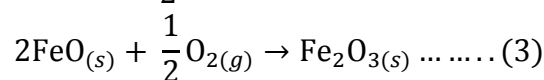
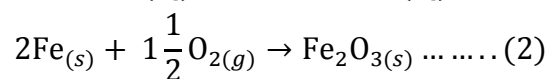
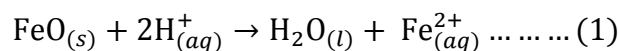

Equation (3) x ½:

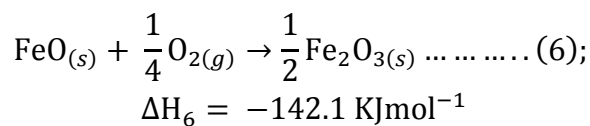

Equation (6) + (4) + (5):

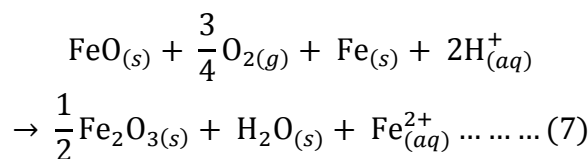
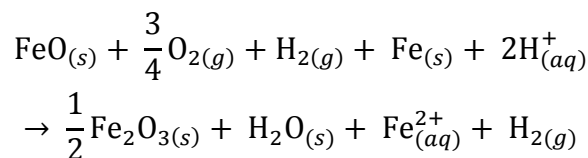

$$\Delta H_7 = -142.1 + (-285.8) + (-86.2) \text{ KJmol}^{-1}$$
$$\Delta H_7 = -514.1 \text{ KJmol}^{-1}$$

Equation (2) by ½:

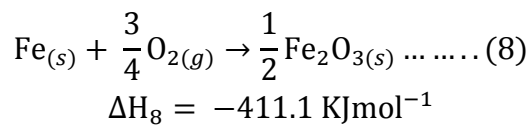

Reversing Equation (8)

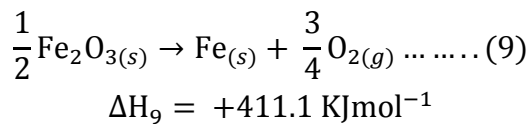

Equation (9) + (7):

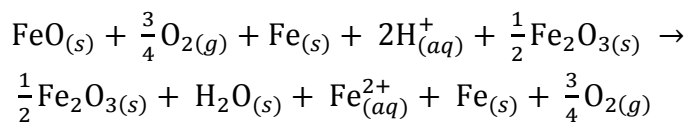

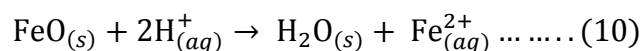

$$\Delta H_{10} = +411.1 + (-514.1) \text{ KJmol}^{-1}$$

$$\Delta H_{10} = -103.0 \text{ KJmol}^{-1}$$

Since Equation (10) = Equation (1), and $\Delta H_{10} = \Delta H_1$, the change in enthalpy for the reaction is $-103.0 \text{ KJmol}^{-1}$

12.6 Bond Energies

Whenever a chemical bond is formed energy is always released. Conversely, energy is required to break a chemical bond. The concept of bond energy for diatomic molecules is simpler but difficulties arise when polyatomic molecules are considered. Hence, it is essential to make a distinction between 'bond energy' and 'bond dissociation energy' of a given chemical bond.

Bond Dissociation Energy

The energy required to break a given bond in a specific compound is defined as the bond dissociation energy. It is a definite value and depends on the presence of other groups in a molecule. For example, the bond dissociation energies of the two O–H linkages in water molecule are different. The energy required to break the first O–H bond in water is 498 KJ.

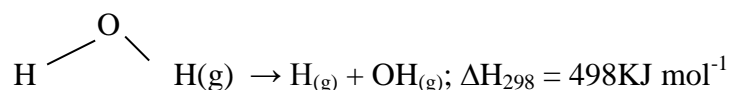

And the energy required to break the O–H bond in hydroxyl group is only 430 KJmol^{-1} .

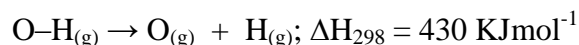

Thus, the bond dissociation energy of O–H linkage in water molecule is 498 KJ whereas that in a hydroxyl group is only 430 KJ. This is explained by the decreasing tendency of equal share of the shared pair of electrons by the bonded atoms and thus increasing bond length and consequently weakening of the bond.

Bond Energy

The average of dissociation energies of a given bond in a series of different dissociating species is termed as bond energy. In the case of diatomic molecules the bond energy and bond dissociation energy are identical. The O–H bond energy in water molecule is the average of the two bond dissociation energies.

That is,

$$H_{\text{O-H}} = \frac{498 + 430}{2} = 464 \text{ KJmol}^{-1}$$

Calculation of Bond Energy

The primary value of average bond energies lies in the calculation of heats of reactions involving compounds for which enthalpy data are not available. The main sources of data for the determination of bond energies are:

1. molecular spectroscopy
2. electron impact studies; and
3. thermochemistry which is being considered here.

The concept of bond energy helps us understand at the molecular level the reason some reactions are exothermic and others endothermic. If the bond in the product molecules is stronger than those in the reactants, the reaction will be exothermic i.e. 'weak' bond → 'strong' bond; $\Delta H < 0$. If the reverse of the reaction is the case, heat will have to be absorbed to bring about the reaction to result. Thus, 'strong' bond → 'weak' bond; $\Delta H > 0$.

For example, consider the reaction between hydrogen and fluorine.

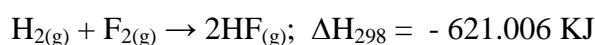

The fact that the reaction gives out heat implies that the bonds in HF are 'stronger' than those in the elementary substances H_2 and F_2 , i.e. the amount of heat released when two moles of H–F bonds are formed is 621.006 KJ greater than that absorbed in breaking one mole of H–H and one mole of F–F bonds.

The thermal stability of molecules is therefore directly related to the strengths of bonds holding them together. That is, the stronger the bond, the greater the bond energy and the greater the thermal stability of the molecules.

Example 2

Calculate the C–H bond energy in methane

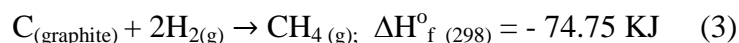
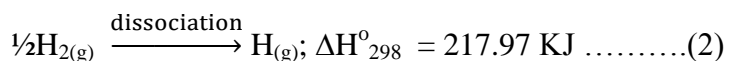

Solution

Since all the four C–H bonds in methane are equivalent, the average of the four bond dissociation energies would be equal to the C–H bond energy.

Multiply Equation (2) by four and then reverse this new equation as well as Equation (1) to give Equations (4) and (5) respectively.

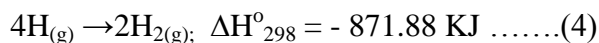

Now combine Equations (3), (4) and (5) together to give:

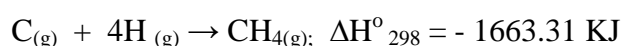

This is the enthalpy change during the formation of four equivalent C – H bonds of methane. Thus, the average bond energy for the C – H bond is $\frac{1663.31 \text{ KJ}}{4} = 415.8 \text{ KJ}$

12.7 Heats of Reaction from Bond Energy Data

Bond energy data are used to calculate the heats of gaseous reactions involving substances having covalent bonds. But in practice we seldom calculate the heats of reaction from bond energies if heat of formation data are available for all the compounds taking part in the reaction. This is because in most cases it is not possible to assign an exact value to a bond energy since it varies to some extent with the species in which the bond is found. In using bond energy data, a plus sign is affixed to the bond enthalpies when a bond is broken since heat is absorbed under such conditions; and a minus sign when a bond is formed since heat is released.

Example 3

Using bond energy data, calculate the enthalpy change for the reaction

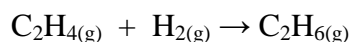

Solution

The reaction can be written as;

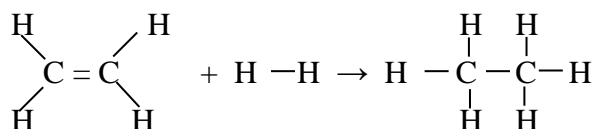

In this reaction, the 4C–H bonds in C_2H_4 are not affected and a double bond is broken; in H_2 one H–H bond is broken. In turn, two new C–C bonds and one C–O bond are formed in C_2H_6 .

Thus, using bond energy data, we have

$$\begin{aligned} \Delta H_{298}^\circ &= -(\Delta H_{\text{c-c}}^\circ + 2\Delta H_{\text{c-H}}^\circ) + (\Delta H_{\text{c=c}}^\circ + \Delta H_{\text{H-H}}^\circ) \\ &= -(348 + 2 \times 413) + (610 + 436) \\ &= -128 \text{ KJ} \end{aligned}$$

The experimentally observed value of the enthalpy of hydrogenation of ethene has been found to be -136 KJ

12.8 Born–Haber Cycle

When a solution is formed, two processes take place simultaneously. These are the disordering of the crystal lattice resulting into the formation and interaction of the ions with the molecules of the solvent. The heat of solution is the combined result of these two processes. Thus, heat of solution = lattice energy + solvation energy. The two – step process is represented as

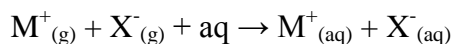

The energy released when one mole of the solid crystal is formed from its constituent ions in gaseous state is termed the lattice energy which is equal in magnitude but opposite in sign to the energy required to break down one mole of the crystal to its gaseous ions separated apart by infinite distance. This energy can be calculated using ionisation (or potential) energy and electron affinity data for the atoms of the constituent elements of the crystal along with the standard heat of formation of the substance from its elements. This calculation is easy because all the quantities are from its elements. This calculation is easy because all the quantities are taken as state functions. However, one simple way to calculate the lattice energy is to use the Born – Haber Cycle for a solid, MX as represented below.

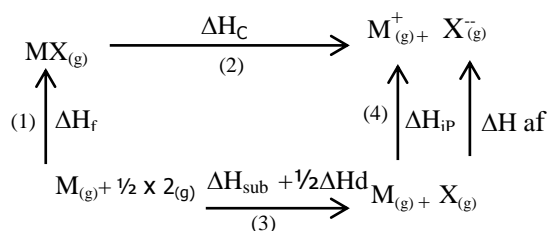

The first step (1) involves the formation of one mole of the solid MX from its elements in their standard state, for which the heat of formation is given by ΔH_f° ,

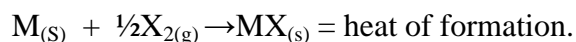

The second step (2) is the dissociation of the lattice crystal to form the gaseous ions $M^+_{(g)}$ and $X^-_{(g)}$ for which the energy is ΔH_c°

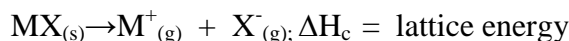

Step three (3) involves the sublimation of $M_{(s)}$ to $M_{(g)}$ for which ΔH_{sub} is the heat of sublimation and the dissociation process of $\frac{1}{2}X_{2(g)} \rightarrow X_{(g)}$ with the heat of dissociation as $\frac{1}{2}\Delta H_d$ (ΔH_d = heat of dissociation per mole of the substance). The total thermal effect for process (3) is

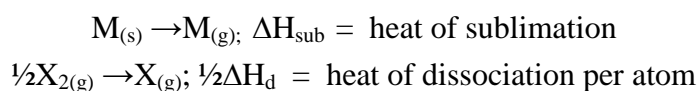

Step four (4) involves the ionization of $M_{(g)}$ by supplying ionization energy ΔH_{IP} and the acceptance of electrons as

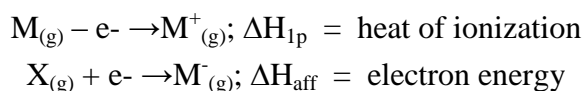

Since ΔH is a state function, the thermal changes for step (1) plus step (2) must be equal to those for step (3) and step (4).

That is,

$$\begin{aligned} \Delta H_f^\circ + \Delta H_C &= \Delta H_{\text{sub}} + \frac{1}{2}\Delta H_d + \Delta H_{\text{IP}} + \Delta H_{\text{aff}} \\ \text{or } \Delta H_C &= (\Delta H_{\text{sub}} + \frac{1}{2}\Delta H_d + \Delta H_{\text{IP}} + \Delta H_{\text{aff}}) - \Delta H_f^\circ \\ \text{or } \Delta H_f^\circ &= (\Delta H_{\text{sub}} + \frac{1}{2}\Delta H_d + \Delta H_{\text{IP}} + \Delta H_{\text{aff}}) - \Delta H_C \end{aligned}$$

Thus,

1. The lattice energy or the crystal energy (ΔH_C) can be calculated using the second above equation by putting in the known values with the appropriate signs of the various quantities.

2. Any one quantity can be calculated if others are known. The use of this equation along with the heat of solution data is discussed below in calculating the heat of hydration for Li ions.

Example 4

Examine the reactions tabulated below with the accompanying changes in enthalpy.

Process	Reaction	Enthalpy Change (KJ)
Sublimation	$\text{Li}_{(s)} \rightarrow \text{Li}_{(g)}$	$\Delta H_{\text{sub}} = 161$
Dissociation	$\frac{1}{2}\text{Cl}_{2(g)} \rightarrow \text{Cl}_{(g)}$	$\frac{1}{2}\Delta H_{\text{d}} = 122$
ionization	$\text{Li}_{(g)} \rightarrow \text{Li}^+_{(g)} + e^-$	$\frac{1}{2}\Delta H_{\text{Ip}} = 520$
Electron affinity	$\text{Cl}_{(g)} + e^- \rightarrow \text{Cl}^-_{(g)}$	$\frac{1}{2}\Delta H_{\text{aff}} = 350$
Compound formation	$\text{Li}_{(s)} + \frac{1}{2}\text{Cl}_{2(g)} \rightarrow \text{LiCl}_{(s)}$	$\Delta H_f^\circ = 410$

- (a) Prepare Born – Haber cycle for the LiCl system and calculate its lattice energy.
 (b) Using the following heats of solution of LiCl in water along with the lattice energy data obtained in (a) above, calculate the heat of hydration of Li^+ ions.
 i) $\text{LiCl}_{(s)} \rightarrow \text{Li}^+_{(\text{aq})} + \text{Cl}^-_{(\text{aq})} + 35.11\text{KJ}$

Solution

- a) Born-Haber cycle is prepared as discussed for the general case of MX. For the reaction, $\text{LiCl}_{(s)} \rightarrow \text{Li}^+_{(g)} + \text{Cl}^-_{(g)}$

$$\Delta H_c = \Delta H_{\text{sub}} + \frac{1}{2}\Delta H_{\text{d}} + \Delta H_{\text{Ip}} + \Delta H_{\text{aff}} - \Delta H_f^\circ$$

$$\Delta H_c = 161 + 122 + 520 - 350 +$$

$$410$$

$$\Delta H_c = 863 \text{ KJ}$$

b) Heat of hydration = Heat of solution - Lattice energy.

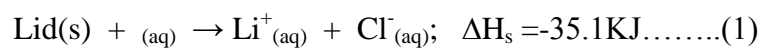

Crystal formation process



Adding (1) and (2), we have

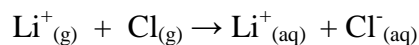

$$\Delta H_{\text{hydration}} = -898.1 \text{ KJ}$$

CHAPTER THIRTEEN

13.0 Chromatography

Chromatography is a separation techniques based on differential partitioning between the mobile and stationary phases. The differences in a partition coefficient of a compound result in differential retention on the stationary phase and thus changing the separation. The mixture is dissolved in a fluid called the mobile phase, which carries it through a structure holding another material called the stationary phase. The various constituents of the mixture travel at different speeds, causing them to separate.

Chromatography may be preparative or analytical. The purpose of preparative chromatography is to separate the components of a mixture for more advanced use (and is thus a form of purification). Analytical chromatography is done normally with smaller amounts of material and is for measuring the relative proportions of analytes in a mixture. The two are not mutually exclusive.

Chromatography is a way of separating and identifying several materials from a mixture. This method uses the following principles:

1. Adsorption
2. Partition
3. Ion Exchange
4. Exclusion – molecular sieve/Gel permeation

These principles are such that if a fluid containing a number of substances is allowed to pass through an adsorbent medium the different substances in the fluid may travel at different rates and thus be separated.

There are different types of chromatography. Amongst them are:

1. Thin layer/paper chromatography
2. Column chromatography
3. Gas chromatography

13.1 Chromatography Terms

- The analyte is the substance to be separated during chromatography. It is also normally what is needed from the mixture.
- Analytical chromatography is used to determine the existence and possibly also the concentration of analyte(s) in a sample.
- A bonded phase is a stationary phase that is covalently bonded to the support particles or to the inside wall of the column tubing.
- A chromatogram is the visual output of the chromatograph. In the case of an optimal separation, different peaks or patterns on the chromatogram correspond to different components of the separated mixture.
- A chromatograph is equipment that enables a sophisticated separation, e.g. gas chromatographic or liquid chromatographic separation.
- Chromatography is a physical method of separation that distributes components to separate between two phases, one stationary (stationary phase), the other (the mobile phase) moving in a definite direction.
- The eluate is the mobile phase leaving the column.
- The eluent is the solvent that carries the analyte.
- An eluotropic series is a list of solvents ranked according to their eluting power.
- An immobilized phase is a stationary phase that is immobilized on the support particles, or on the inner wall of the column tubing.
- The mobile phase is the phase that moves in a definite direction. It may be a liquid (LC and Capillary Electrochromatography (CEC)), a gas (GC), or a supercritical fluid (supercritical-fluid chromatography, SFC). The mobile phase consists of the sample being separated/analyzed and the solvent that moves the sample through the column. In the case of HPLC the mobile phase consists of a non-polar solvent(s) such as hexane in normal

phase or polar solvents in reverse phase chromatography and the sample being separated. The mobile phase moves through the chromatography column (the stationary phase) where the sample interacts with the stationary phase and is separated.

- Preparative chromatography is used to purify sufficient quantities of a substance for further use, rather than analysis.
- The retention time is the characteristic time it takes for a particular analyte to pass through the system (from the column inlet to the detector) under set conditions.
- The sample is the matter analyzed in chromatography. It may consist of a single component or it may be a mixture of components. When the sample is treated in the course of an analysis, the phase or the phases containing the analytes of interest is/are referred to as the sample whereas everything out of interest separated from the sample before or in the course of the analysis is referred to as waste.
- The solute refers to the sample components in partition chromatography.
- The solvent refers to any substance capable of solubilizing another substance, and especially the liquid mobile phase in liquid chromatography.
- The stationary phase is the substance fixed in place for the chromatography procedure. Examples include the silica layer in thin layer chromatography
- The detector refers to the instrument used for qualitative and quantitative detection of analytes after separation.

13.2 Paper Chromatography

In the separation of colours in green leaf, the solvent (ethanol) rises up the chromatographic paper and after some time green and yellow bands of colour are seen.

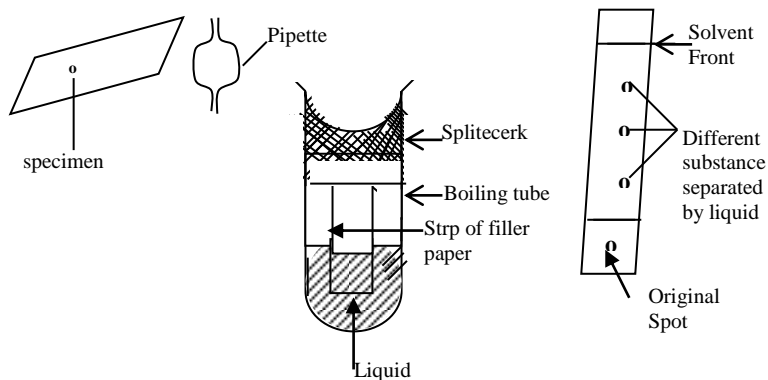

Figure 13.1: Illustration of paper chromatography

The green colour is chlorophyll and the yellow bands are carotenes.

13.3 Column Chromatography

This is one which uses an adsorbent in a column. A glass is filled with a specially prepared adsorbent say CaCO_3 . Other adsorbent in use are MgO_3 , Na_2CO_3 , ion exchange resins, clay and gels.

With CaCO_3 , as adsorbent, a solution of mixture to be separated is added to the top of the column. A suitable solvent is then added to the top so that it gradually flows down.

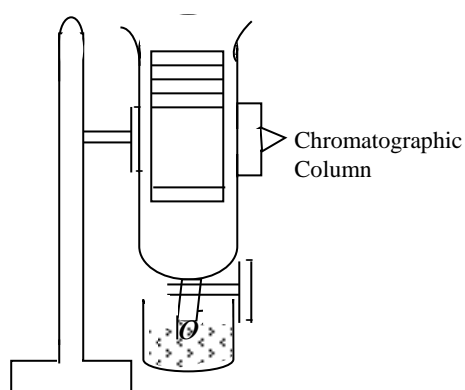
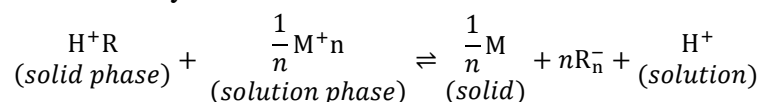

Figure 13.2: Illustration of column chromatography

The separation of the compounds of a mixture results from different rate of flow or adsorption for each component. Each constituents of the mixture travel at a different rate down the tube and the constituents are separated.

13.4 Ion-Exchange

This is based on the fact that the ion-exchanger passes insoluble phase with fixed ionic sites of one charge; while the oppositely charged species are free to move about in the solvent and be replaced by other ions of like charged; provided that electroneutrality is maintained.



Exchange is between the point marked X and being (+) it is cationic exchange. If (-) is involved, it become anionic exchange. A typical example is

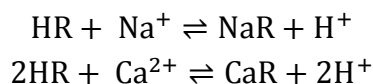

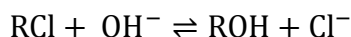

where, R represents the resin matrix. The Law of mass action applies and therefore the equilibrium constant takes the form

$$K = \frac{\alpha_{NaR} \partial H^+}{\alpha_{HR} \alpha_{Na^+}} = \frac{(NaR)(H^+)}{(HR)(Na^+)} \times \frac{f_{NaR} f_{H^+}}{f_{HR} f_{Na^+}}$$

K is constant only if the activities of the various species are used, otherwise it will vary with relative and total concentration due to changes in activity coefficients.

Applications of Ion Exchange

Ion exchange is widely used in the food and beverage, hydrometallurgical, metals finishing, chemical and petrochemical, pharmaceutical, sugar and sweeteners, ground and potable water, nuclear, softening and industrial water, semiconductor, power, and a host of other industries.

1. Most typical example of application is preparation of high purity water for power engineering, electronic and nuclear industries; i.e. polymeric or mineralic insoluble ion exchangers are widely used for water softening, water purification, water decontamination, etc.
2. Ion exchange is a method widely used in household (laundry detergents and water filters) to produce soft water. This is accomplished by exchanging calcium Ca^{2+} and magnesium Mg^{2+} cations against Na^+ or H^+ cations (see water softening). Another application for ion exchange in domestic water treatment is the removal of nitrate and natural organic matter.
3. Industrial and analytical ion exchange chromatography is another area to be mentioned. Ion exchange chromatography is a chromatographic method that is widely used for chemical analysis and separation of ions. For example, in biochemistry it is widely used to separate charged molecules such as proteins. An important area of the application is extraction and purification of biologically

produced substances such as proteins (amino acids) and DNA/RNA.

4. Ion exchange processes are used to separate and purify metals, including separating uranium from plutonium and other actinides, including thorium, and lanthanum, neodymium, ytterbium, samarium, lutetium. From each other and other lanthanides. There are two series of rare earth metals, the lanthanides and the actinides, both of whose families all have very similar chemical and physical properties.
5. The ion-exchange process is also used to separate other sets of very similar chemical elements, such as zirconium and hafnium, which is also very important for the nuclear industry. Zirconium is practically transparent to free neutrons, used in building reactors, but hafnium is a very strong absorber of neutrons, used in reactor control rods.
6. Ion exchangers are used in nuclear reprocessing and the treatment of radioactive waste.
7. Ion exchange resins in the form of thin membranes are used in chloroalkali process, fuel cells and vanadium redox batteries. Ion exchange can also be used to remove hardness from water by exchanging calcium and magnesium ions for sodium ions in an ion exchange column.
8. Liquid (aqueous) phase ion exchange desalination has been demonstrated. In this technique anions and cations in salt water are exchanged for carbonate anions and calcium cations respectively using electrophoresis. Calcium and carbonate ions then react to form calcium carbonate, which then precipitates leaving behind fresh water. The desalination occurs at ambient temperature and pressure and requires no membranes or solid ion exchangers. Theoretical energy efficiency of this method is on par with electrodialysis and reverse osmosis.

13.5 Electrophoresis

This is the movement of colloidal particles in an electric field. Colloidal particles dispersed in aqueous medium often carry an electric charge. For this reason electrophoresis has become a valuable tool for separating biological fractions into pure components. Electrophoresis can show that even if a sample is homogeneous with respect to molecular mass it may contain different components having different electrical properties.

13.6 Colloids

A colloid is one of the three primary types of mixtures, with the other two being a solution and suspension. A colloid is a solution that has particles ranging between 1 and 1000 nanometers in diameter, yet the particles still able to remain evenly distributed throughout the solution. These are also known as colloidal dispersions because the substances remain dispersed and do not settle to the bottom of the container. In colloids, one substance is evenly dispersed in another. The substance being dispersed is referred to as being in the dispersed phase, while the substance in which it is dispersed is in the continuous phase.

In order to be classified as a colloid, the substance in the dispersed phase must be larger than the size of a molecule but smaller than what can be seen with the naked eye. This can be more precisely quantified as one or more of the substance's dimensions must be between 1 and 1000 nanometers. If the dimensions are smaller than this the substance is considered a solution and if they are larger than the substance is a suspension.

A common method of classifying colloids is based on the phase of the dispersed substance and what phase it is dispersed in. The types of colloids include sol, emulsion, foam, and aerosol (Table 13.1).

When the dispersion medium is water, the colloidal system is often referred to as a hydrocolloid. The particles in the

dispersed phase can take place in different phases depending on how much water is available. A hydrophilic colloid, or hydrocolloid, is defined as a colloid system in which the colloid particles are hydrophilic polymers dispersed in water. Hydrocolloids can be either reversible or irreversible (single-state). For example, agar is a reversible hydrocolloid of seaweed extract; it can exist in a gel or liquid state and can alternate between states with either heating or cooling. Many hydrocolloids are derived from natural sources. For example, gelatin is produced by hydrolysis of proteins from cows and fish, and pectin is extracted from citrus peel and apple pomace. Hydrocolloid-based medical dressings are used for skin and wound treatment.

A hydrophobic colloid, or emulsion, is defined as a colloid system where the particles are hydrophobic polymers. Since the colloid does not interact with the aqueous solvent, hydrophobic colloids are inherently unstable and generally do not form spontaneously. Energy input, through shaking, stirring, or homogenizing, is needed to form the emulsion.

Table 13.1: Classes of colloids based on the dispersion mediums

Dispersion Medium	Dispersed Phase	Type of Colloid	Example
Solid	Solid	Solid sol	Ruby glass
Solid	Liquid	Solid emulsion/gel	Pearl, cheese
Solid	Gas	Solid foam	Lava, pumice
Liquid	Solid	Sol	Paints, cell fluids
Liquid	Liquid	Emulsion	Milk, oil in water
Liquid	Gas	Foam	Soap suds, whipped cream
Gas	Solid	Aerosol	Smoke
Gas	Liquid	Aerosol	Fog, mist

Confirmation of Colloids

Tyndall Effect

An easy way of determining whether a mixture is colloidal or not is through use of the Tyndall Effect. When light is shined through a true solution, the light passes cleanly through the solution, however when light is passed through a colloidal solution, the substance in the dispersed phases scatters the light in all directions, making it readily seen. An example of this is shining a flashlight into fog. The beam of light can be easily seen because the fog is a colloid.

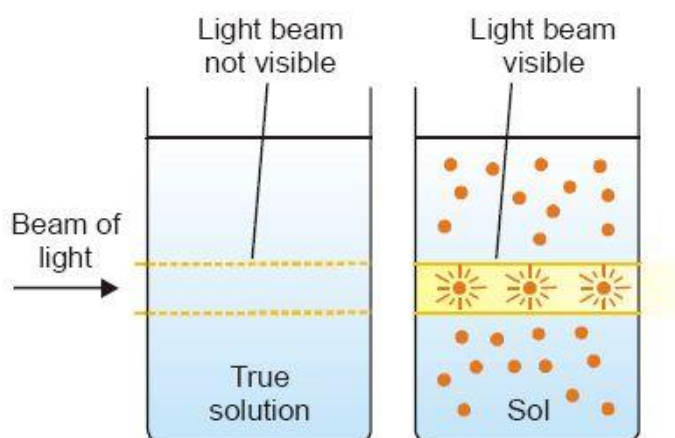

Figure 13.3: Tyndall effect

Dialysis

Another method of determining whether a mixture is a colloid is by passing it through a semipermeable membrane. The larger dispersed particles in a colloid would be unable to pass through the membrane, while the surrounding liquid molecules can. Dialysis takes advantage of the fact that colloids cannot diffuse through semipermeable membranes to filter them out of a medium.

13.7 Surface Tension

The molecules in a sample of a liquid that find themselves fully in the interior volume are surrounded by other molecules and

interact with them based on the attractive intermolecular forces that are present for molecules of this type. However, the molecules at the interface with another medium (usually air) do not have other like molecules on all of their sides (namely, on top of them), so they cohere more strongly to the molecules on the surface and immediately below them. The result is a surface film which makes it more difficult for an object to pierce through the surface than for it to move once submerged in the sample of liquid. Therefore, the cohesive forces result in the phenomenon of *surface tension*.

Surface tension is a property of liquids that results from the tendency of liquids to minimize their surface area. In order to minimize their surface area, liquids form drops that are spherical as long as there is no gravity. The layer of molecules on the surface behave differently than the interior because the cohesive forces on the surface molecules have a net pull into the liquid interior.

The surface layer acts like an elastic skin because they have fewer neighbours to attract them, the surface molecules are less stable than those in the interior have a higher potential energy. The surface tension of a liquid is the energy required to increase the surface area of a given amount at room temperature.

The stronger the intermolecular attractive forces, the higher the surface tension will be. Raising the temperature of a liquid reduces its surface tension; raising the temperature of the liquid increases the average kinetic energy of the molecules the increased molecular motion makes it easier to stretch the surface.

Surface tension is expressed in units of force per unit length or of energy per unit area (for instance, N/m or J/m²). The two are equivalent, but when referring to energy per unit area, the term "surface energy," is used, which is a more general term in the sense that it applies to solids as well as to liquids. Surface tension is responsible for the shape of a liquid droplet. Although easily deformed, droplets of water tend to be pulled into a spherical shape by the cohesive forces of the surface

layer. In the absence of other forces, including gravity, drops of virtually all liquids would be perfectly spherical. If no force acts normal (perpendicular) to a tensioned surface, the surface must remain flat. But if the pressure on one side of the surface differs from pressure on the other side, the pressure difference times the surface area results in a normal force. In order for the surface tension forces to cancel out this force due to pressure, the surface must be curved. When all the forces are balanced, the curvature of the surface is a good measure of the surface tension, which is described by the Young-Laplace equation:

$$\Delta P = \gamma \left(\frac{1}{R_1} + \frac{1}{R_2} \right) \dots \dots \dots (1)$$

where, ΔP is the pressure differential across the interface, γ is the measured surface tension, and R_1, R_2 are the principal radii of curvature, which indicate the degree of curvature.

13.8 Adsorption and Absorption

Absorption

In chemistry, absorption is a physical or chemical phenomenon in which atoms, molecules or ions enter some bulk phase gas, liquid or solid material. This is a different process from adsorption, since molecules undergoing absorption are taken up by the volume, not by the surface (as in the case for adsorption). A more general term is sorption, which covers absorption, adsorption, and ion exchange. Absorption is a condition in which something takes in another substance.

The process of absorption means that a substance captures and transforms energy. The absorbent distributes the material it captures throughout whole and adsorbent only distributes it through the surface. The reddish colour of copper is an example of this process because it is caused due to its absorption of blue light.

Types of Absorption

Absorption is a process that may be chemical (reactive) or physical (non-reactive).

Physical Absorption

Physical absorption or non-reactive absorption is made between two phases of matter: a liquid absorbs a gas, or a solid absorbs a liquid. When a liquid solvent absorbs a gas mixture or part of it, a mass of gas moves into the liquid. For example, water may absorb oxygen from the air. This mass transfer takes place at the interface between the liquid and the gas, at a rate depending on both the gas and the liquid. This type of absorption depends on the solubility of gases, the pressure and the temperature. The rate and amount of absorption also depend on the surface area of the interface and its duration in time. For example, when the water is finely divided and mixed with air, as may happen in a waterfall or a strong ocean surf, the water absorbs more oxygen.

When a solid absorbs a liquid mixture or part of it, a mass of liquid moves into the solid. For example, a clay pot used to store water may absorb some of the water. This mass transfer takes place at the interface between the solid and the liquid, at a rate depending on both the solid and the liquid. For example, pots made from certain clays are more absorbent than others. Absorption is essentially a molecule attaching themselves to a substance and will not be attracted from other molecules.

Chemical Absorption

Chemical absorption or reactive absorption is a chemical reaction between the absorbed and the absorbing substances. Sometimes it combines with physical absorption. This type of absorption depends upon the stoichiometry of the reaction and the concentration of its reactants.

Adsorption

Adsorption is the adhesion of atoms, ions, or molecules from a gas, liquid, or dissolved solid to a surface. This process creates a film of the adsorbate on the surface of the adsorbent. This

process differs from absorption, in which a fluid (the adsorbate) permeates or is dissolved by a liquid or solid (the adsorbent). Adsorption is a surface-based process while absorption involves the whole volume of the material. The term sorption encompasses both processes, while desorption is the reverse of it. Adsorption is a surface phenomenon. The substance thus adsorbed on the surface is called the adsorbate and the substance on which it is adsorbed is known as adsorbent. The reverse process i.e. removal of the adsorbed substance from the surface is called desorption. The adsorption of gases on the surface of metals is called occlusion.

Similar to surface tension, adsorption is a consequence of surface energy. In a bulk material, all the bonding requirements (be they ionic, covalent, or metallic) of the constituent atoms of the material are filled by other atoms in the material. However, atoms on the surface of the adsorbent are not wholly surrounded by other adsorbent atoms and therefore can attract adsorbates. The exact nature of the bonding depends on the details of the species involved, but the adsorption process is generally classified as physisorption (characteristic of weak van der Waals forces) or chemisorption (characteristic of covalent bonding). It may also occur due to electrostatic attraction.

Adsorption is present in many natural, physical, biological, and chemical systems, and is widely used in industrial applications such as activated charcoal, capturing and using waste heat to provide cold water for air conditioning and other process requirements (adsorption chillers), synthetic resins, increase storage capacity of carbide-derived carbons, and water purification. Adsorption, ion exchange, and chromatography are sorption processes in which certain adsorbates are selectively transferred from the fluid phase to the surface of insoluble, rigid particles suspended in a vessel or packed in a column. Lesser known, are the pharmaceutical industry applications as a means to prolong neurological exposure to specific drugs or parts thereof.

Classes of Industrial Adsorbents

1. Oxygen-containing compounds – Are typically hydrophilic and polar, including materials such as silica gel and zeolites.
2. Carbon-based compounds – Are typically hydrophobic and non-polar, including materials such as activated carbon and graphite.
3. Polymer-based compounds – Are polar or non-polar functional groups in a porous polymer matrix.

Table 13.2: Difference between Adsorption and Absorption

Adsorption	Absorption
It is surface phenomenon i.e. it occurs only at the surface of the adsorbent.	It is bulk phenomenon i.e. it occurs throughout the body of the material.
In this phenomenon, the concentration on the surface of adsorbent is different from that in the bulk.	In this phenomenon, the concentration is same throughout the material.
Its rate is high in the beginning and then decreases till equilibrium is attained.	Its rate remains same throughout the process.

13.9 Gels

Gels are defined as a substantially dilute cross-linked system, which exhibits no flow when in the steady-state. By weight, gels are mostly liquid, yet they behave like solids due to a three-dimensional cross-linked network within the liquid. It is the crosslinking within the fluid that gives a gel its structure (hardness) and contributes to the adhesive stick (tack). In this way gels are a dispersion of molecules of a liquid within a solid in which the solid is the continuous phase and the liquid is the discontinuous phase.

Gels consist of a solid three-dimensional network that spans the volume of a liquid medium and ensnares it through surface

tension effects. This internal network structure may result from physical bonds (physical gels) or chemical bonds (chemical gels), as well as crystallites or other junctions that remain intact within the extending fluid.

Types of Gels

Hydrogels

A hydrogel is a network of polymer chains that are hydrophilic, sometimes found as a colloidal gel in which water is the dispersion medium. Hydrogels are highly absorbent (they can contain over 90% water) natural or synthetic polymeric networks. Hydrogels also possess a degree of flexibility very similar to natural tissue, due to their significant water content.

Organogels

An organogel is a non-crystalline, non-glassy thermo-reversible (thermoplastic) solid material composed of a liquid organic phase entrapped in a three-dimensionally cross-linked network. The liquid can be, for example, an organic solvent, mineral oil, or vegetable oil.

The solubility and particle dimensions of the structurant are important characteristics for the elastic properties and firmness of the organogel. Organogels have potential for use in a number of applications, such as in pharmaceuticals, cosmetics, art conservation, and food. An example of formation of an undesired thermoreversible network is the occurrence of wax crystallization in petroleum

Xerogels

A xerogel is a solid formed from a gel by drying with unhindered shrinkage. Xerogels usually retain high porosity (15–50%) and enormous surface area (150–900 m²/g), along with very small pore size (1–10 nm). When solvent removal occurs under supercritical conditions, the network does not shrink and a highly porous, low-density material known as an aerogel is produced. Heat treatment of a xerogel at elevated temperature produces viscous sintering (shrinkage of the

xerogel due to a small amount of viscous flow) and effectively transforms the porous gel into a dense glass.

Applications

1. Many substances can form gels when a suitable thickener or gelling agent is added to their formula. This approach is common in manufacture of wide range of products, from foods to paints and adhesives.
2. In fiber optics communications, a soft gel resembling "hair gel" in viscosity is used to fill the plastic tubes containing the fibers. The main purpose of the gel is to prevent water intrusion if the buffer tube is breached, but the gel also buffers the fibers against mechanical damage when the tube is bent around corners during installation, or flexed. Additionally, the gel acts as a processing aid when the cable is being constructed, keeping the fibers central whilst the tube material is extruded around it.